

DEPARTMENT OF THE ARMY
TECHNICAL MANUAL

DEPARTMENT OF THE AIR
FORCE TECHNICAL ORDER

TM 9-8012
TO 36A5-2-41

OPERATION
AND ORGANIZATIONAL
MAINTENANCE

1/4-TON 4 x 4
UTILITY TRUCK
M38



DEPARTMENTS OF THE ARMY AND THE AIR FORCE

JANUARY 1956

This manual is correct to 11 August 1955

*TM 9-8012/TO 36A5-2-41

TECHNICAL MANUAL } DEPARTMENTS OF THE ARMY AND
No. 9-8012 } THE AIR FORCE
TECHNICAL ORDER }
No. 36A5-2-41 } WASHINGTON 25, D. C., 12 January 1956

¼-TON 4 X 4 UTILITY TRUCK

	Paragraphs	Page
CHAPTER 1. INTRODUCTION		
Section I. General -----	1-3	3
II. Description and data -----	4-6	6
CHAPTER 2. OPERATING INSTRUCTIONS		
Section I. Service upon receipt of materiel -----	7-10	18
II. Controls and instruments -----	11-41	20
III. Operation under usual conditions -----	42-53	28
IV. Operation of materiel used in conjunction with major item. -----	54, 55	37
V. Operation under unusual conditions -----	56-61	40
CHAPTER 3. ORGANIZATIONAL MAINTENANCE INSTRUCTIONS		
Section I. Parts, special tools, and equipment for operation and organizational maintenance. -----	62-65	48
II. Lubrication and painting -----	66-72	50
III. Preventive maintenance service -----	73-76	59
IV. Troubleshooting -----	77-100	72
V. Engine description and maintenance in vehicle. -----	101-113	105
VI. Engine removal and installation -----	114-119	122
VII. Cooling system -----	120-126	140
VIII. Fuel and air intake system -----	127-136	149

* This manual supersedes TM 9-804, 29 September 1950, C 1, 16 February 1951, C 2, 18 May 1951, C 3, 10 April 1953; TB ORD 470, 9 September 1952; TB 9-804-1, 8 July 1952; TB 9-804-2, 17 July 1952; TB 9-804-3, 16 February 1953; TB 9-804-4, 17 February 1953; TB 9-804-5, 13 March 1953; TB 9-804-6, 13 March 1953; TB 9-804-7, 20 May 1953; TB 9-804-8, 15 June 1953; TB 9-804-9, 9 March 1955; TB 9-804-10, 1 November 1955; TB 9-804-11, 19 October 1955; and those portions of TB ORD 247, 14 May 1951; TB ORD 445, 7 May 1952; TB ORD 467, 11 August 1952; TB ORD 485, 19 January 1953; TB ORD 499, 4 March 1953; TB ORD 547, 18 December 1953; TB ORD 554, 7 January 1955; TB ORD 560, 13 May 1954 pertaining to materiel covered herein.

	<i>Paragraphs</i>	<i>Page</i>
Section IX. Exhaust system -----	137-139	172
X. Ignition system -----	140-146	175
XI. Starting system -----	147-150	187
XII. Generating system -----	151-153	192
XIII. Batteries and lighting system -----	154-164	196
XIV. Winch assembly -----	165-171	213
XV. Instrument cluster, instruments, gages, switches, sending units, and horn. -----	172-189	220
XVI. Radio interference suppression -----	190-194	231
XVII. Clutch -----	195, 196	233
XVIII. Transfer and power-take-off assemblies -----	197-202	234
XIX. Transmission assembly -----	203-207	237
XX. Propeller shafts with universal joint assemblies -----	208-211	239
XXI. Rear axle -----	212-220	246
XXII. Front axle -----	221-231	254
XXIII. Steering system -----	232-239	267
XXIV. Brake system -----	240-247	277
XXV. Springs and shock absorbers -----	248-253	293
XXVI. Wheels and tires -----	254-257	299
XXVII. Body and frame -----	258-271	302
XXVIII. Maintenance under unusual conditions -----	272-276	318
 CHAPTER 4. SHIPMENT OF MATERIEL AND DESTRUCTION TO PREVENT ENEMY USE		
Section I. Shipment materiel -----	277-281	323
II. Destruction of materiel to prevent enemy use --	282-285	331
APPENDIX REFERENCES -----		385
INDEX -----		340

CHAPTER 1

INTRODUCTION

Section I. GENERAL

1. Scope

a. These instructions are published for the use of personnel to whom this materiel is issued. They contain information on the operation and organizational maintenance of the materiel as well as descriptions of major units and their functions in relation to other components of the materiel.

b. The appendix contains a list of current references, including supply manuals, forms, technical manuals, and other available publications applicable to the materiel.

c. This manual differs from TM 9-804, September 1950, as indicated in (1), (2), and (3) below.

(1) Adds information on—

- (*a*) Plate showing “OFF” and “ON” positions under ignition switch, beginning with vehicle serial No. 26273.
- (*b*) A changed submersible starter mounting, beginning with vehicle serial No. 53262.
- (*c*) A submersible generator, beginning with vehicle serial No. 53262.
- (*d*) A sealed or pressurized bell housing, beginning with vehicle serial No. 53262.
- (*e*) A waterproof clutch linkage, beginning with vehicle serial No. 53262.
- (*f*) A $\frac{1}{8}$ -inch hole in crankshaft pulley for timing purposes, beginning with vehicle serial No. 22296.
- (*g*) Vent lines to bell housing, transfer case and transmission case, beginning with vehicle serial No. 53262.
- (*h*) Decalcomania above deep water fording vent valve control, for locating bell housing drain plug and fording information, beginning with vehicle serial No. 53262.
- (*i*) New engine rear plate for use with the changed starter mounting, beginning with vehicle serial No. 78513.
- (*j*) Decalcomania on fuel tank cap, beginning with vehicle serial No. 14693.

- (k) Distributor and voltage regulator harness assembly, beginning with vehicle serial No. 20600.
 - (l) Indicates different length of speedometer cables used.
 - (m) Cleaning of crankcase control valve and fuel filter element.
 - (n) Installation of oil filter flexible inlet line and carburetor to fuel pump line.
 - (o) Installation of thermostat housing retainer.
 - (p) Installation of polarizing bracket for trailer coupling connector receptacle.
 - (q) Replacement of old and new type stop light switches.
 - (r) Installation of front axle brake line clamps.
- (2) Revises information on—
- (a) Light switch, beginning with vehicle serial No. 66736.
 - (b) Name, date, caution, and instruction plates.
 - (c) Alemite fittings, beginning with vehicle serial No. 28300.
 - (d) Instrument cluster, beginning with vehicle serial No. 65043.
 - (e) Gear oil specification, in lubrication order temperature range +40° F. to -10° F., using GO 75 in place of GO 90.
 - (f) Forms, records, and reports.
 - (g) Table I, special tools and equipment for organizational maintenance.
 - (h) Circuit breaker, beginning with vehicle serial No. 65928.
- (3) Deletes reference to cartridge-type oil filter which was used only on pilot models. Cuno oil filter was used in all production vehicles.

2. Organizational Maintenance Allocation

In general, the prescribed organizational maintenance responsibilities will apply as reflected in the allocation of tools and spare parts in the appropriate columns of the current ORD 7 supply manual pertaining to this vehicle and in accordance with the extent of disassembly prescribed in this manual for the purpose of cleaning, lubricating, or replacing authorized spare parts. In all cases where the nature of repair, modification, or adjustment is beyond the scope or facilities of the using organization,

the supporting ordnance maintenance unit should be informed in order that trained personnel with suitable tools and equipment may be provided or other proper instructions issued.

Note. The replacement of certain assemblies, that is, engine, transmission, transfer, and power-take-off assemblies, winch assembly, front axle, rear axle, and steering gear is normally an ordnance maintenance operation, but may be performed in an emergency by the using organization, provided approval for performing these replacements is obtained from the supporting ordnance officer. A replacement assembly, any tools needed for the operation which are not carried by the using organization, any necessary special instructions regarding associated accessories, etc., may be obtained from the supporting organizational maintenance unit.

3. Forms, Records, and Reports

a. General. Responsibility for the proper execution of forms, records, and reports rests upon the officers of all units maintaining this equipment. However, the value of accurate records must be fully appreciated by all persons responsible for their compilation, maintenance, and use. Records, reports, and authorized forms are normally utilized to indicate the type, quantity, and condition of materiel to be inspected, to be repaired, or to be used in repair. Properly executed forms convey authorization and serve as records for repair or replacement of materiel in the hands of troops and for delivery of materiel requiring further repair to ordnance shops in arsenals, depots, etc. The forms, records, and reports establish the work required, the progress of the work within the shops, and the status of the materiel upon completion of its repair.

b. Authorized Forms. The forms generally applicable to units operating and maintaining these vehicles are listed in the appendix. No forms other than those approved for the Department of the Army will be used. For a complete listing of all forms, see DA Pam 310-2.

c. Field Report of Accidents. The reports necessary to comply with the requirements of the Army safety program are prescribed in detail in the SR 385-10-40 series of special regulations. These reports are required whenever accidents involving injury to personnel or damage to materiel occur.

d. Report of Unsatisfactory Equipment or Materials. Any suggestions for improvement in design and maintenance of equipment and spare parts, safety and efficiency of operation, or pertaining to the application of prescribed petroleum fuels, lubricants, and/or preserving materials or technical inaccuracies noted in Department of Army Publications, will be reported through technical channels, as prescribed in AR 700-38, to the Chief of

Ordnance, Washington 25, DC, ATTN: ORDFM, using DA Form 468, Unsatisfactory Equipment Report. Such suggestions are encouraged in order that other organizations may benefit.

Note. Do not report all failures that occur. Report only REPEATED or RECURRENT failures or malfunctions which indicate unsatisfactory design or material. However, reports will always be made in the event that exceptionally costly equipment is involved. See also AR 700-38 and printed instructions on DA Form 468.

Section II. DESCRIPTION AND DATA

4. Description

a. General. The 1/4-ton 4 x 4 utility truck M38 is equipped with one front axle and one rear axle, with four driving wheels. The design of this vehicle locates the four-cylinder gasoline engine forward of the driving compartment, under the hood, and provides a four-passenger, open-type body. The body may be inclosed with removable canvas top, side curtains, and doors which are held in place and supported by suitable metal rods, braces, and canvas straps. The vehicle is used as a general purpose personnel or cargo carrier especially designed for adaptation to general reconnaissance, command, communications, or other special duties. The windshield can be folded forward to lie flat on the hood for low silhouette and forward firing. The spare wheel and tire are mounted on the rear of the body. Suitable brackets and compartments are incorporated in and on the body for carrying equipment. The frame is equipped with a towing pintle at the rear and lifting shackles at the front and rear to permit towing or lifting the vehicle. General physical characteristics of the vehicle are shown in figures 1, 2, and 3. The terms "right," "left," "front," and "rear" are established with reference to the operator sitting in the driver's seat. "Right" indicates the side to the right of the operator. "Left" indicates the side to the left of the operator. "Front" indicates the radiator end of the vehicle. "Rear" indicates the end opposite the radiator.

b. Engine. Power for the vehicle is supplied by an I-head, four-cylinder gasoline engine, mounted at three points on cushion mounts on the frame. The engine, with accessories, is accessible when the hood is in the raised position.

c. Transmission. The conventional three-speed, selective-gear transmission is mounted directly to the rear of the engine and clutch assemblies. The transmission has three forward and one reverse speeds as indicated on the shifting instruction plate (fig. 4). These speeds are manually selected by the driver by means of the transmission gearshift lever. The lever is mounted on top

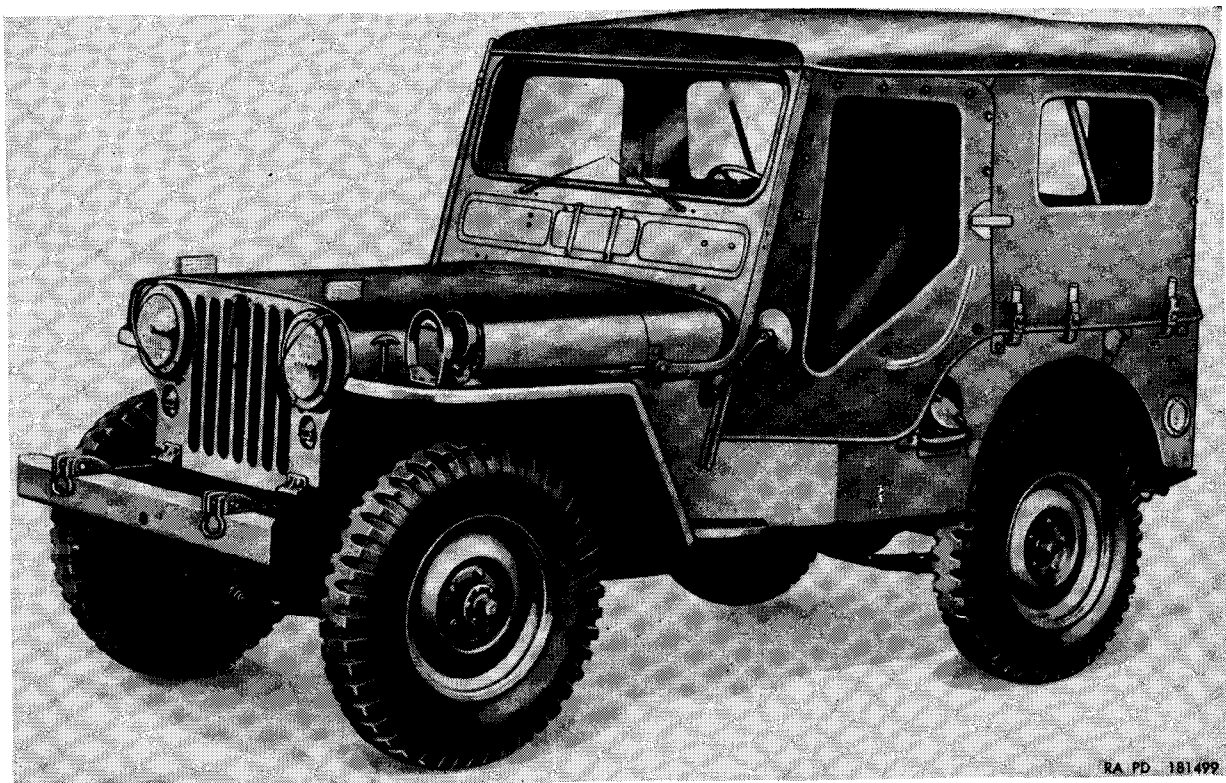

RA. PD. 181499

Figure 1. 1/4-ton 4 x 4 utility truck M38—left front view—top up.

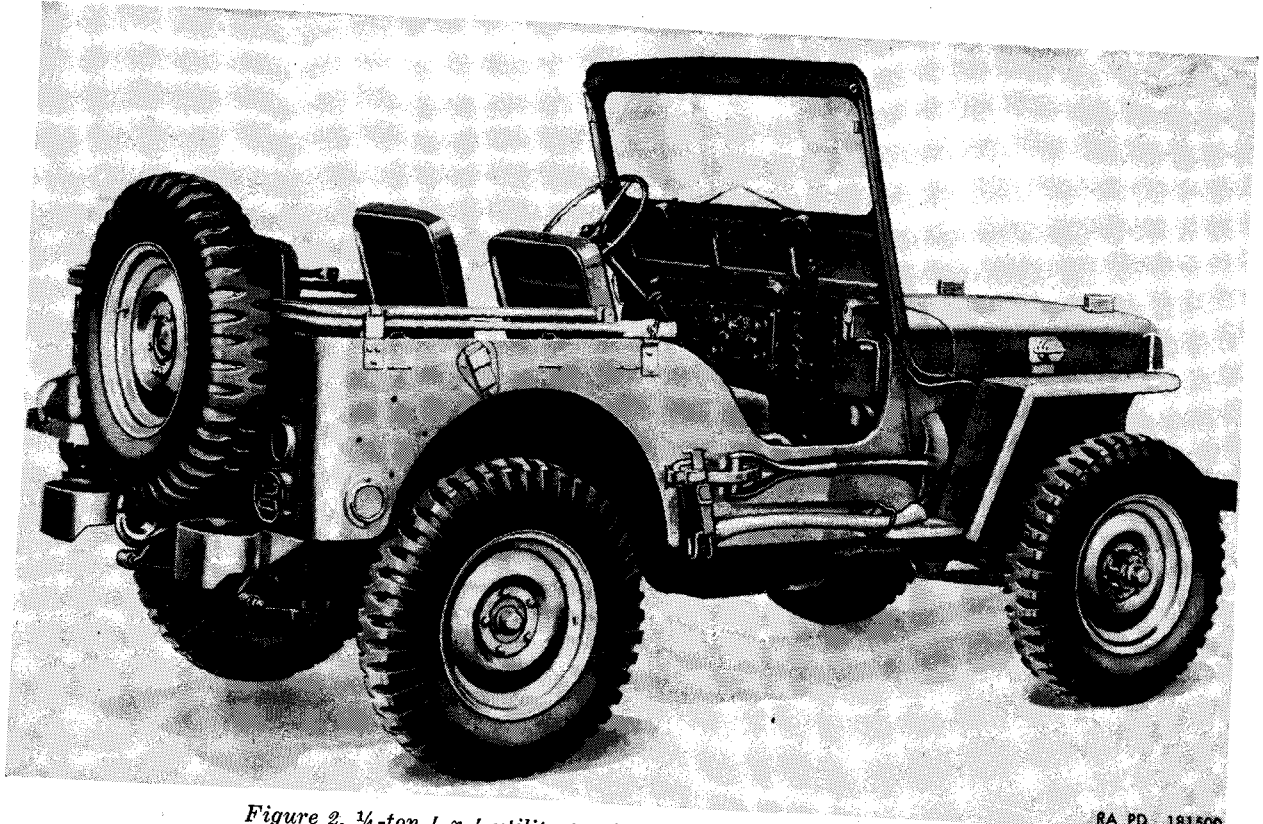
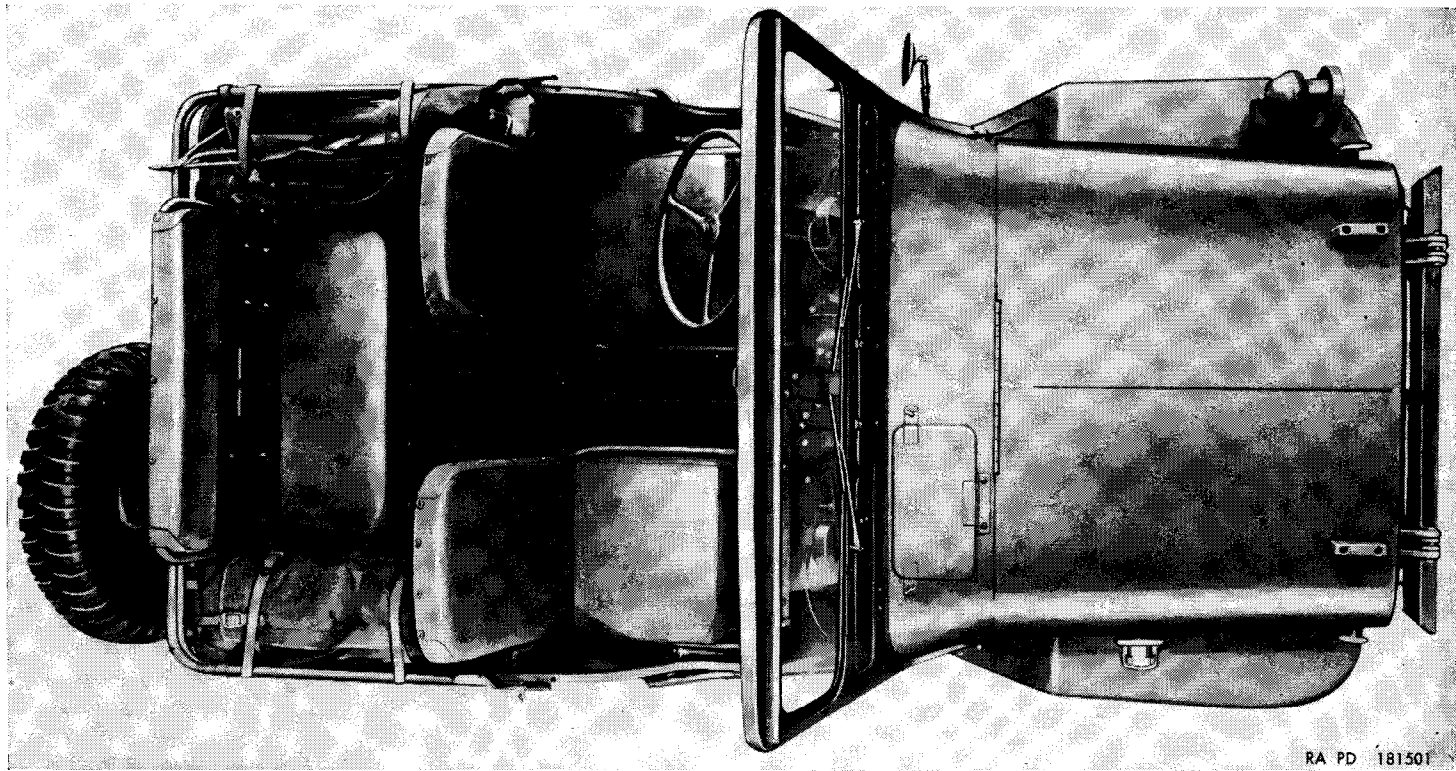

Figure 2. 1/4-ton 4 x 4 utility truck M38—right rear view—top down.

RA PD 181500



RA PD 181501

Figure 3. 1/4-ton 4 x 4 utility truck M38—top view—top down.

of the transmission and extends into the driver's compartment.

d. Transfer. To supplement the gear ratio of the transmission, a two-speed transfer is mounted on the rear of the transmission. The transfer provides additional gear reduction for negotiating difficult terrain, a power-take-off for the winch, and a means of transmitting power to the front axle. The transfer is manually operated by the driver through a set of transfer gearshift levers on top of the transfer. The levers extend into the driving compartment to the right of the transmission gearshift lever.

e. Front Axle and Suspension. The front axle is a full-floating, single-reduction-type with hypoid drive gears. Incorporated in the front axle are constant velocity-type universal joints at the steering knuckles. A propeller shaft provides a connection from the front axle to the transfer for the transmission of power. Power through the transfer is controlled by a transfer gearshift lever in the driving compartment. Suspension of the front axle consists of two semielliptic springs, shackled to the frame at the front of the spring, secured to the frame at the rear of the spring by pivot bolts, and attached to the front axle by U-bolts.

f. Rear Axle and Suspension. The rear axle is a semifloating, single-reduction-type with hypoid drive gears. The rear axle is connected to the transfer by a propeller shaft for the transmission of power. Suspension of the rear axle consists of two semielliptic springs shackled to the frame at the rear of the spring, secured to the frame at the front of the spring by pivot bolts, and attached to the rear axle by U-bolts.

g. Brake Systems. The service brakes are actuated hydraulically using full-floating brake shoes. Service brakes are on all four wheels and are operated by the brake pedal in the driving compartment. The hand brake is a mechanical brake at the rear of the transfer and is operated by pulling the hand brake handle outward from the instrument panel. A ratchet holds the handle in a locked position which can be released by a quarter turn in either direction.

h. Electrical System. The electrical system furnishes current for ignition, lights, sending units, etcetera. Current is generated by a 24-volt, belt-driven generator, and stored in two 12-volt storage batteries connected in series.

5. Name, Data, Caution, and Instruction Plates

a. Name and Data Plates.

- (1) *Vehicle identification plate* (fig. 4). The vehicle identification plate is located on the instrument panel at the right of the instrument cluster. The plate includes ve-

- hicle name, serial number, manufacturer's name, ordnance stock number, part number, model number, contract number, and year manufactured.
- (2) *Vehicle servicing data instruction plate* (fig. 4). The vehicle servicing data instruction plate is located on the instrument panel at the right of the instrument cluster. This plate includes servicing information of the electrical system, fuel octane, tire inflation pressures, engine, gear oil, chassis grease, and instructions for cooling system. If data plate specifies gear oil (GO) grade 90 for temperatures of $+40^{\circ}$ to -10° F., it should be changed to grade 75. Tire pressure for highway driving should be changed from 28 to 25 pounds.
 - (3) *Responsible agency plate* (fig. 4). The responsible agency plate is located on the instrument panel at the right of the instrument cluster. The plate gives a list of the agencies responsible for maintenance of various parts of the vehicle.
 - (4) *Vehicle shipping data plate* (fig. 4). The vehicle shipping data plate is located on the instrument panel at the right of the instrument cluster. The plate provides information on vehicle dimensions, weights, and maximum towed load.
 - (5) *Distributor and ignition coil assembly name and data plate* (fig. 6). The distributor and ignition coil assembly name and data plate is located on the right side of distributor and ignition coil assembly. The plate includes manufacturer's name, model number, and voltage data.
 - (6) *Starter name and data plate* (fig. 4). The starter name and data plate is located on the left side of the starter. The plate includes the voltage, direction of rotation, ordnance part number, manufacturer's name, serial, and model numbers.
 - (7) *Generator name and data plate* (fig. 4). The generator name and data plate is located on the right side of the generator. The plate includes the ordnance part number, voltage, amperage, manufacturer's name, serial, and model numbers.
 - (8) *Generator regulator data plate* (fig. 6). The generator regulator data plate is located on the left side of the generator regulator base. The plate gives data on voltage rating, capacity and serial, model, and ordnance numbers.

WARNING
 DISCONNECT BATTERY LEADS BEFORE WORKING
 ON GENERATOR OR REGULATOR INSTALLATIONS.
 DISCONNECT GROUND LEAD FIRST.

BATTERY CABLE DISCONNECTION DECALCOMANIA

TRUCK UTILITY 1/4 TON 4x4 M 38
 ORDINANCE STOCK NO. 0 240400000
 MFG. BY WALKER OVERLAND MOTORS INC.
 TOLEDO OHIO
 MFR. MODEL NO. MFR. SER. NO.
 MFR. PART NO. PART NO. DATE DEL.
 CONTRACT NO. INSPECTED
 RA 32 014 ORD 830

VEHICLE IDENTIFICATION PLATE

CAUTION
 MAXIMUM PERMISSIBLE ROAD SPEEDS
 IN THE FOLLOWING GEAR POSITIONS

TRANSMISSION	TRANSFER CASE IN	
	HIGH RANGE	LOW RANGE
HIGH	60 MPH	24 MPH
INTERMEDIATE	40	16
LOW	21	9
REVERSE	16	6

VEHICLE ROAD SPEED CAUTION PLATE

FRONT
 TRANSMISSION TRANSFER CASE

DISENGAGE FRONT AXLE DRIVE
 WHEN OPERATING ON DRY HARD
 SURFACED ROADS

PUBLICATIONS
 PARTS LIST SNL G-740
 OPERATORS MANUAL TM 9-804
 MAINTENANCE MANUALS
 TM 9-1804A TM 9-1804B
 LUBRICATION ORDER LO 9-804

SHIFTING INSTRUCTION PLATE

STARTER 24V. D.C.
 CRANKING

SPEC. NO. TYPE ORDER NO.
 MFR. NO. SERIAL NO.
 M07 400101 3H325004

STARTER NAME AND DATA PLATE

GENERATOR 24-VOLT D.C.
 RATING TYPE CLASS SPEED RANGE

25A 1 B 1 750 8000
 MFR. NO. SERIAL NO.
 A44012 11633802

GENERATOR NAME AND DATA PLATE

WEIGHT AND DIMENSION DATA FOR TRUCK, UTILITY 1/4 TON 4x4 M 38

WEIGHTS	EMPTY	CROSS	HIGH
W/O CREW		COUNTRY	WAY
PAYLOAD		ROD	1200
FRONT AXLE	13.3	430	240
REAR AXLE	21.1	194	230
TOTAL (GROSS)	26.5	350	18.5
MAX. TOWED LOAD	1500	2000	
W/PALE TOWED			
SHIPPING CURBWEIGHT	260	117	

VEHICLE SHIPPING DATA PLATE

SERVICING DATA, TRUCK, 1/4 TON, 4 X 4, ELECTRICAL SYSTEM 24 V.

GASOLINE OCTANE NO. MIN 68 TIRE INFLATION PRESSURES

GASOLINE TANK CAPACITY 13 GALS	HIGHWAY 25 LBS
COOL. NG. SYSTEM CAPACITY 11.5 QTS	CROSS COUNTRY 25 LBS
CRANKCASE CAPACITY 4 QTS	MUD SAND OR SNOW 10 LBS

TEMPERATURE	ENGINE OIL	GEAR OIL	GREASE
ABOVE 32 F.	OF GRADE 88	50 GRADE 90	CG GRADE 00
32 F. TO 30 F.	75 GRADE 100A	50 GRADE 77	CG GRADE 00
0 F. TO 32 F.	50 GRADE 085	50 GRADE 505	CG GRADE 00

TO DRAIN COOL. NG. SYSTEM OPEN RADIATOR COCK LOCATED ON HIGH FITTING AT LOWER LEFT SIDE OF RADIATOR AND CYL. BLOCK DRAIN COCK ON RIGHT SIDE OF ENGINE BETWEEN GENERATOR AND STARTER.

VEHICLE SERVICING DATA INSTRUCTION PLATE

RESPONSIBLE AGENCY

NAME	PHONE	MAIL ADDRESS
NAME	PHONE	MAIL ADDRESS
NAME	PHONE	MAIL ADDRESS
NAME	PHONE	MAIL ADDRESS

RESPONSIBLE AGENCY PLATE

RA PD 181502A

Figure 4. Vehicle name, data, caution, and instruction plates.

- (9) *Name, patent, and serial number plate* (fig. 5). The name, patent, and serial number plate is located on the inside of the body on the front of right rear wheel fender well.

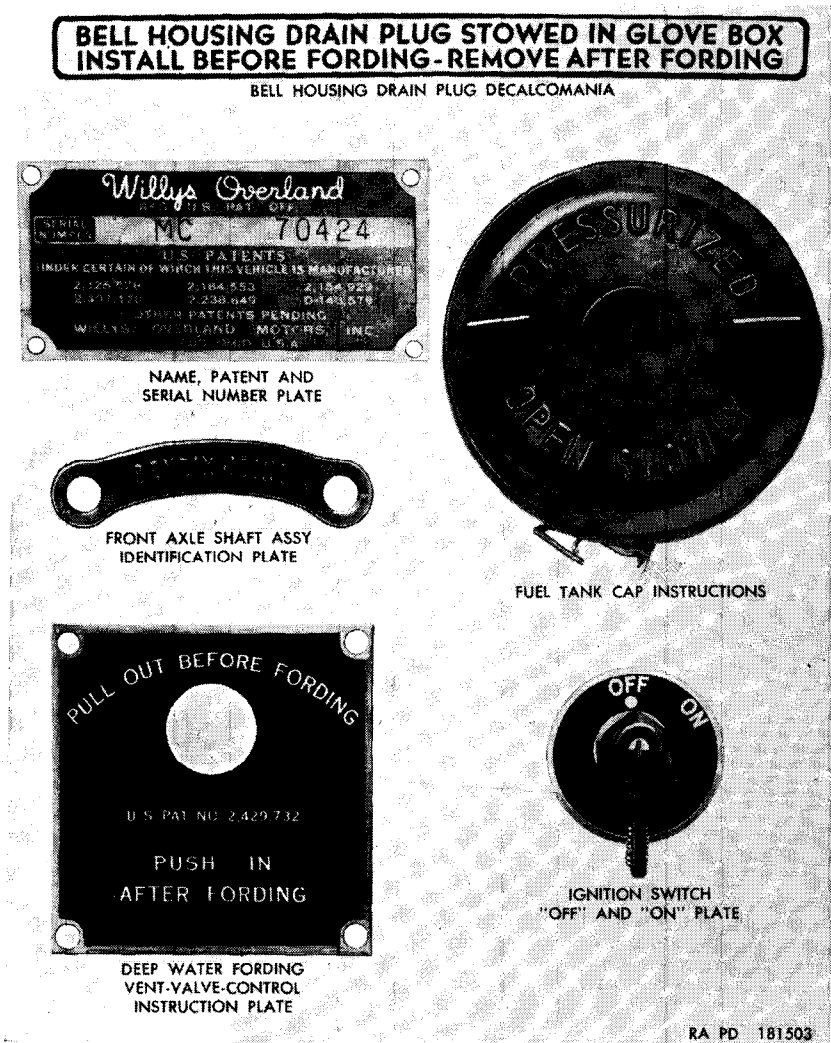

Figure 5. Instruction decalcomania and data plates.

b. Name, Model, and Serial Number Locations.

- (1) *Engine serial number* (fig. 6). The engine serial number is stamped on the engine cylinder block behind the water pump and below the thermostat housing at the front of the engine.

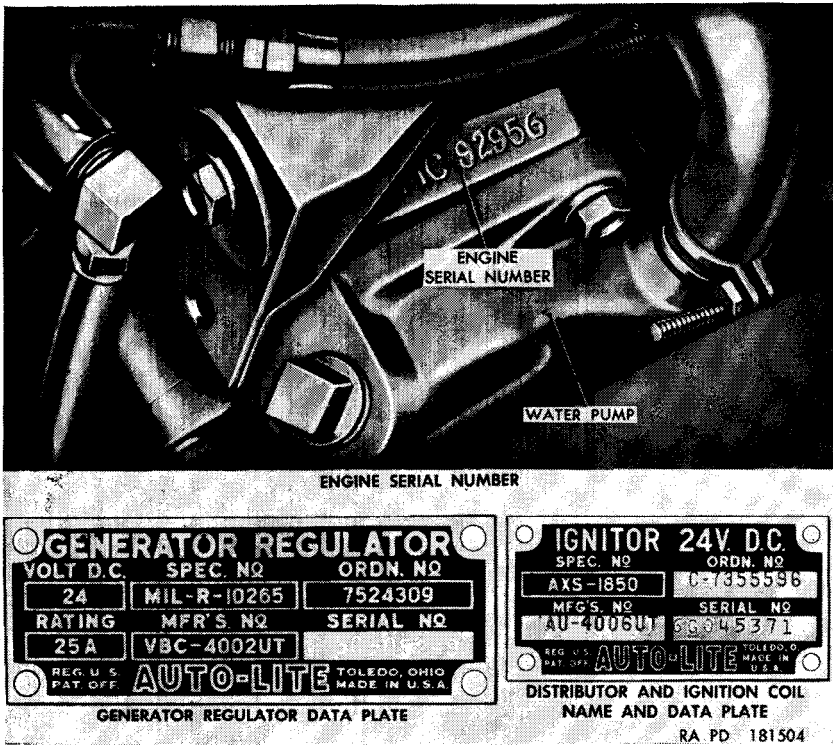

Figure 6. Data plates and engine serial number location.

- (2) *Transmission name, model, and serial number* (fig. 90). The manufacturer's serial number is stamped at the top right corner of the transmission case. The name and model number are cast into the right rear side of the transmission case.
- (3) *Transfer name, model, and serial number*. The manufacturer's serial number (fig. 32) is stamped on top of the front flange on the left side of the transfer case. The name and model number are cast into the rear of the transfer case (fig. 90).
- (4) *Carburetor name and model location* (S, fig. 44). The carburetor name and model number are cast into the carburetor float bowl.
- (5) *Generator regulator name*. The generator regulator name is stamped on the top of the generator regulator cover.
- (6) *Front axle shaft identification plate* (fig. 6). This plate is held by two of the screws securing the steering knuckle oil seal assembly, and identifies the type of joint used in the front axle.

c. *Caution Plates.*

- (1) *Vehicle road speed caution plate* (fig. 4). The vehicle road speed caution plate is located on the instrument panel at the right of the instrument cluster. This plate gives information on permissible speeds for various selected gear positions.
- (2) *Generator regulator warning.* A warning is stamped on the top of the generator regulator cover. This warning instructs operator to disconnect the battery ground cable before attempting to remove generator or generator regulator.

d. *Instruction Plates and Decalcomanias.*

- (1) *Shifting instruction plate* (fig. 4). The shifting instruction plate is located on the instrument panel at the right of the instrument cluster. The plate gives a shifting diagram for the transmission and transfer and shows the lever positions for engagement and disengagement of the front axle. A list of the applicable publications issued for the vehicle also is included.
- (2) *Deep water fording vent valve control instruction plate.* The deep water fording vent valve control instruction plate (fig. 5) is attached to the instrument panel behind the deep water fording vent valve control (H, fig. 7). The plate gives instructions for operating the control when fording.
- (3) *Battery cable disconnection decalcomania* (fig. 4). The battery cable disconnection decalcomania, providing instructions for disconnecting battery cables when working on electrical units, is located on the cover of battery "A" at the right front fender.
- (4) *Ignition switch OFF and ON plate* (fig. 5). The ignition switch OFF and ON plate is located on the instrument panel to the left of the instrument cluster around the ignition switch (G, fig. 7) (MWO ORD G740-W5). The plate indicates whether the switch is on or off.
- (5) *Bell housing drain plug decalcomania* (fig. 5). The bell housing drain plug decalcomania is located on the instrument panel to the left of the instrument cluster and above the ignition switch. It gives the location of plug when not in use, and installation instructions.
- (6) *Fuel tank cap instructions* (fig. 5). The fuel tank cap is located on the left side of the vehicle. A decalcomania

on early production vehicles and a stamping in late production vehicle caps warns that the tank is pressurized and the cap must be removed slowly. See paragraph 127 for description of fuel tank cap.

6. Tabulated Data

a. General Data.

Capacities:

Cooling system -----	11½ qt
Crankcase (refill) -----	4 qt
Differentials (ea) -----	2½ pt
Fuel tanks -----	13 gal
Transfer case -----	3 pt
Transmission -----	2 pt
Winch -----	2 pt
Crew -----	2
Cylinders (in line) -----	4

Dimensions:

Height (top up) -----	74 in.
Height (top down) -----	68 in.
Length -----	133 in.
Width -----	62 in.
Electrical system -----	24 v
Engine -----	Model MC
Ground clearance (min) (rear axle) -----	9¼ in.
Loading height (empty) (top down) -----	44 in.
Number of batteries -----	2
Passengers (incl crew) -----	4

Pintle height (rear):

Empty -----	20 in.
Loaded (cross-country) -----	18¼ in.
Loaded (highway) -----	17¾ in.

Tires:

Size and type—Military nondirectional mud and snow 6 ply, 7.00 x 16

Pressure:

Highway -----	25 psi
Cross-country -----	25 psi
Mud, sand, or snow -----	10 psi

Weight:

Gross:

On highway -----	3,950 lb
Off highway -----	3,550 lb

Net ----- 2,750 lb

Pay load:

On highway -----	1,200 lb
Off highway -----	800 lb

Wheelbase ----- 80 in.

b. Performance.

Allowable speed:

	<i>1st</i>	<i>2d</i>	<i>3d</i>	<i>Reverse</i>
Transfer case in high range	21	40	60	16 mph
Transfer case in low range	6	12	22	5 mph
Angle:				
Approach	-----			55 deg
Departure	-----			35 deg
Cruising range (loaded)	-----			225 mi at 35 mph
Cruising speed	-----			55 mph
Engine horsepower (bhp):				
At 2,000 rpm	-----			40 bhp
At 4,000 rpm	-----			60 bhp
Fording depth (max) (w/fording equipment)	-----			74 in.
Fording depth (max) (w/o fording equipment)	-----			30 in.
Fuel consumption (loaded)	-----			17.3 mpg
Grade ascending ability (max)	-----			66.2 per cent
Recommended towed load:				
On highway (max)	-----			2,000 lb
Cross-country (max)	-----			1,500 lb
Turning circle (diam) (right or left) (min)	-----			19 ft
Winch capacity	-----			3,500 lb

c. Detailed Data References. Additional detailed tabulated data pertaining to individual components and systems are contained in the following paragraphs:

	<i>Paragraph</i>
Body and frame	258
Brake system	240
Cooling system	120
Electrical system:	
Battery and lighting system	154
Generating system	151
Ignition system	140
Starting system	147
Engine	101
Front axle	221
Fuel and air intake system	127
Propeller shafts and universal joints	208
Rear axle	212
Springs and shock absorbers	248
Steering system	232
Transfer	197
Transmission and power-take-off	203
Wheels and tires	254
Winch	54

CHAPTER 3

ORGANIZATIONAL MAINTENANCE INSTRUCTIONS

Section I. PARTS, SPECIAL TOOLS, AND EQUIPMENT FOR OPERATION AND ORGANIZATIONAL MAINTENANCE

62. General

Tools, equipment, and spare parts are issued to the using organization for maintaining the materiel. Tools and equipment should not be used for purposes other than prescribed and, when not in use, should be properly stored in the chest and/or roll provided for them.

63. Parts

Spare parts are supplied to the using organization for replacement of those parts most likely to become worn, broken, or otherwise unserviceable providing replacement of these parts is within the scope of organizational maintenance functions. Spare

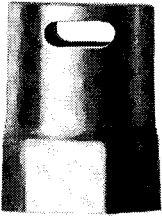
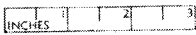

WRENCH —
41-W-3825-200



SCREW —
41-S-1047-330



ADAPTER—
41-A-18-251



SCREW —
41-S-1047-300



REMOVER AND REPLACER —
41-R-2374-845



REMOVER AND REPLACER —
41-R-2374-750

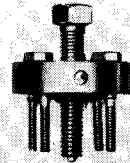

PULLER, WATER PUMP
PULLEY — 41-P-2908-240
RA PD 181511A

Figure 13. Special tools.

parts, tools, and equipment for the ¼-ton 4 x 4 utility truck M38 are listed in ORD 7 SNL G-740, which is the authority for requisitioning replacements.

64. Common Tools and Equipment

Standard and commonly used tools and equipment having general application to this materiel are authorized for issue to 1st echelon by ORD 7 SNL G-740. Common tools and equipment for 2d echelon are listed in ORD 6 SNL J-7, Sections 1, 2, and 3; ORD 6 SNL J-10, Section 4; and are authorized for issue by TA and TOE.

65. Special Tools and Equipment

Certain tools and equipment specially designed for operation and organizational maintenance, repair and general use with the materiel, are listed in table I for information only. This list is not to be used for requisitioning replacements.

Table I. Special Tools and Equipment for Operation and Organizational Maintenance

Item	Identifying No.	References		Use
		Fig.	Par.	
ADAPTER, puller, steering wheel.	41-A-18-251	13, 111	239	Removing steering wheel.
PULLER, water pump pulley.	41-P-2908-240	13, 42	114	Removing water pump pulley.
REMOVER and REPLACER, bearing cup (spindle pin, used w/screw 41-S-1047-300).	41-R-2374-750	13, 104	230	Removing or installing steering knuckle flange bearing cup.
REMOVER and REPLACER, bearing cup (wheel, used w/screw 41-S-1047-330).	41-R-2374-845	13, 100	225	Removing or installing front hub bearing cup.
SCREW, remover and replacer (bearing cup) threaded, ¾-16NF-2, length 6 in.	41-S-1047-300	13, 104	230	Used w/RE-MOVER and REPLACER 41-R-2374-750.
SCREW, remover and replacer (bearing cup) threaded, 1¼-12NF-2.	41-S-1047-330	13, 100	225	Used w/RE-MOVER and REPLACER 41-R-2374-845.
WRENCH, wheel bearing nut, size of opening 2⅞ in., length 3.56 in.	41-W-3825-200	13, 98	224	Removing or replacing wheel bearing nut.

Section II. LUBRICATION AND PAINTING

66. Lubrication Order

Lubrication Order 9-8012 (figs. 14 and 15) prescribes cleaning and lubricating procedures as to locations, intervals, and proper materials for this vehicle. The official lubrication order will be carried with the vehicle at all times. In the event the vehicle is received without a copy, the using organization shall immediately requisition one. See DA Pam 310-4 for lubrication order of current date. Lubrication which is to be performed by ordnance maintenance personnel is listed on the lubrication order in the "NOTES" (fig. 15), and in a few instances are contained in the pertinent section.

67. General Lubrication Instructions

a. General. Any special lubricating instructions required for specific mechanisms or parts are covered in the pertinent sections.

b. Usual Conditions. Service intervals specified on the lubrication order are for normal operation and where moderate temperature, humidity, and atmospheric conditions prevail.

c. Lubrication Equipment. Organizational maintenance tool sets contain lubrication equipment adequate for maintenance. Clean this equipment both before and after use. Operate the lubricating guns carefully and in such a manner as to insure a proper distribution of the lubricant.

d. Points of Application.

- (1) Lubrication points are shown in figures 16 through 19 and are referenced to the lubrication order. Clean fittings and surrounding surfaces as prescribed in lubrication general notes (fig. 14).
- (2) A $\frac{3}{4}$ -inch red circle should be painted around all lubricating fittings, oil can points, and refill plug holes.
- (3) Clean and lubricate unsealed bearings as in (a), (b), and (c) below.
 - (a) Wash all the old lubricant out of the bearings and from the inside of the hubs with volatile mineral spirits or dry-cleaning solvent and dry the parts thoroughly.

Caution: Bearings must not be dried or spun with compressed air. See TM 37-265 for care and maintenance of bearings.

- (b) Pack the bearings by hand or with a mechanical packer introducing the lubricant carefully between the rollers. Do not smear grease only on the outside of the bearings and expect it to work in. Great care must be exercised to insure that dirt, grit, lint, or other contaminants are not introduced into the bearings. If the bearings are not to be installed immediately after repacking, they should be wrapped in clean oilproof paper to protect them from contaminants.
- (c) After the bearings are properly lubricated, pack the hub with a sufficient amount of lubricant to uniformly fill it to the inside diameters of the inner and outer bearing races. Coat the spindles and hub caps with a thin layer of lubricant (not over $\frac{1}{16}$ in.) to prevent rusting. Do not fill the hub caps to serve as grease cups under any circumstances. They should be lightly coated, however, to prevent rusting.

Note. For normal operation, lubricate wheel bearings at 12,000 miles or at annual intervals, whichever comes first.

e. Reports and Records.

- (1) Report unsatisfactory performance of prescribed petroleum fuels, lubricant, or preserving materials, using DA Form 468, Unsatisfactory Equipment Report.
- (2) Maintain a record of lubrication of the vehicle on DA Form 461, Preventive Maintenance Service and Inspection for Wheeled and Half-Track Vehicles.

68. Lubrication Under Unusual Conditions

a. Unusual Conditions. Reduce service intervals specified on lubrication chart, that is lubricate more frequently, to compensate for abnormal or extreme conditions, such as high or low temperatures, prolonged periods of high speed operation, continued operation in sand or dust, immersion in water, or exposure to moisture. Any one of these operations or conditions may cause contamination and quickly destroy the protective qualities of the lubricants. Intervals may be extended during inactive periods commensurate with adequate preservation.

b. Changing Grade of Lubricants. Lubricants are prescribed in the "Key" in the lubrication order (fig. 15) in accordance with three temperature ranges; above $+32^{\circ}$ F., $+40^{\circ}$ F. to -10° F. and from 0° F. to -65° F. Change the grade of lubricants whenever weather forecast data indicate that air temperatures will be consistently in the next higher or lower temperature range or when sluggish starting caused by lubricant thickening occurs.

LUBRICATION ORDER

LC 19-75AAA-8

LO 9-8012

15 May 1954 (Supersedes LO 9-804, 26 April 1951)

TRUCK, ¼-TON, 4 x 4, UTILITY, M38

References: TM 9-804; ORD 7 SNL G-740

Intervals are based on normal operation. Reduce to compensate for abnormal operation, severe conditions or contaminated lubricants. During inactive periods, intervals may be extended commensurate with adequate preservation.

Clean fittings before lubricating. Relubricate after washing or fording. Clean parts with THINNER, paint, volatile, mineral spirits (TPM) or SOLVENT, dry cleaning (SD). Dry before lubricating. Lubricate dotted arrow points on both sides of the equipment.

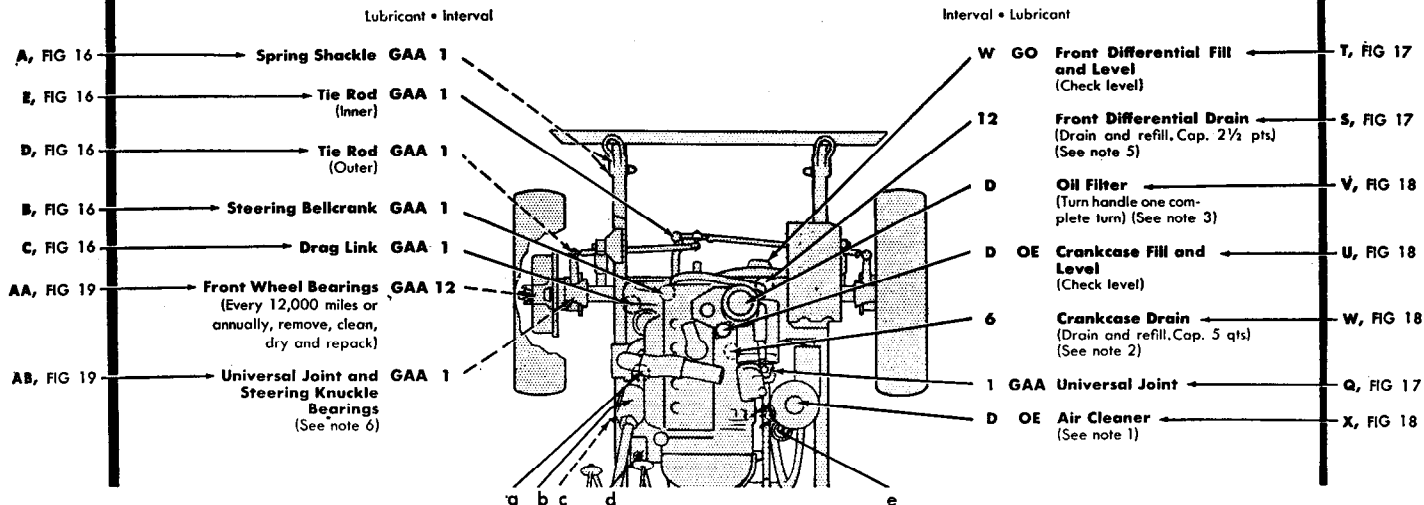

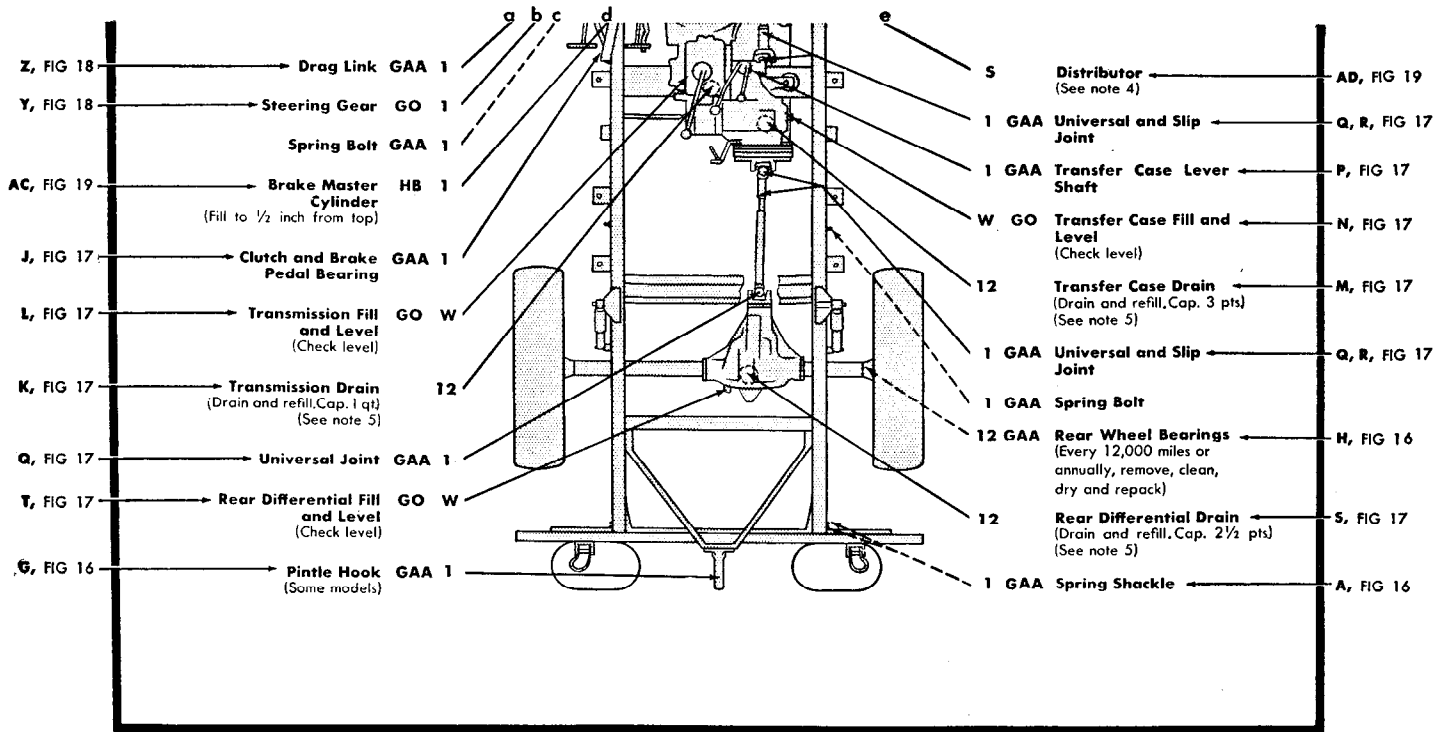

Figure 14. Lubrication order.

RA PD 364009

KEY						
LUBRICANTS	EXPECTED TEMPERATURES			LUBRICANTS	INTERVALS	
	above +32° F	+40° F to -10° F	0° F to -65° F			
OE—OIL, lubr, engine	OE 30	OE 10	OES	OES—OIL, lubr, engine, sub-zero	D—Daily W—Weekly S—Semiannually 1—1,000 Miles 6—6,000 Miles 12—12,000 Miles	
GO—LUBRICANT, gear, universal	GO 90	GO 75	GOS			GO—LUBRICANT, gear, universal, sub-zero
HB—FLUID, hydraulic brake	HB	HB	HBA	HBA—FLUID, hydraulic brake, arctic		
GAA—GREASE, lubr, automotive and artillery	GAA	GAA	GAA			
PL—OIL, lubr, preservative	PL (Med)	PL (Special)	PL (Special)			

NOTES	
<p>1. AIR CLEANER AND BREATHER—[Oil both type] Daily, replenish to bead level with OE, crankcase grade. Every 1,000 miles, clean oil reservoir and refill with OE as above. Disassemble, clean all parts, refill with OE as above whenever crankcase oil is changed. For desert or extremely dusty operation, disassemble, clean all parts and refill with OE once every operating day or more frequently if required.</p> <p>2. CRANKCASE—Drain every 6,000 miles or semi-annually. Drain only when engine is hot. Refill to FULL mark. Run engine a few minutes, recheck level. For satisfactory operation on heavy duty engine oil, engine thermostat must be operating properly to maintain engine coolant temperature at +140° F minimum. CAUTION: Be sure pressure gage indicates oil is circulating.</p> <p>3. OIL FILTER—Every 1,000 miles, remove plug in bottom of case and drain sediment. Every 6,000 miles or semiannually, while crankcase is being drained, remove, clean and inspect element, clean inside of case, install element.</p>	<p>4. DISTRIBUTOR—Semi-annually, wipe breaker cam lightly with GAA and lubricate breaker arm pivot and wick under rotor with 1 to 2 drops of PL.</p> <p>5. GEAR CASES—Drain every 12,000 miles or annually. Drain only when hot after operation. Fill to plug levels before operation and after draining. Clean vents weekly and after operation in water or mud.</p> <p>6. UNIVERSAL JOINT AND STEERING KNUCKLE BEARINGS—Every 1,000 miles, remove plug and fill to level. When wheels are removed for packing, remove steering knuckles, clean and repack universal joint housing. Do not disassemble constant velocity universal joint.</p> <p>7. OIL CAN POINTS—Every 1,000 miles, lubricate hand brake linkage, clutch and brake pedal linkage, pitman hook if not equipped with fittings, with PL.</p> <p>8. DO NOT LUBRICATE—Shock absorbers, springs, clutch release bearing, water pump.</p>
<p>9. LUBRICATED AT TIME OF DISASSEMBLY BY ORDNANCE PERSONNEL—Ventilator dual valve control, throttle control, choke control, steering column bearing (upper), generator, starter, clutch fulcrum ball, clutch release bearing carrier, clutch pilot bearing, hand brake cable, speedometer flexible shaft.</p> <p><i>Copy of this lubrication order will remain with the equipment at all times; instructions contained herein are mandatory and supersede all conflicting lubrication instructions dated prior to the date of this lubrication order.</i></p> <p style="text-align: center;">BY ORDER OF THE SECRETARIES OF THE ARMY AND THE AIR FORCE:</p> <div style="display: flex; justify-content: space-between;"> <div style="width: 45%;"> <p style="text-align: center;">M. B. RIDGWAY, General, United States Army, Chief of Staff.</p> </div> <div style="width: 45%;"> <p style="text-align: center;">N. F. TWINING, Chief of Staff, United States Air Force.</p> </div> </div>	

Figure 15. Lubrication order key.

RA PD 364010

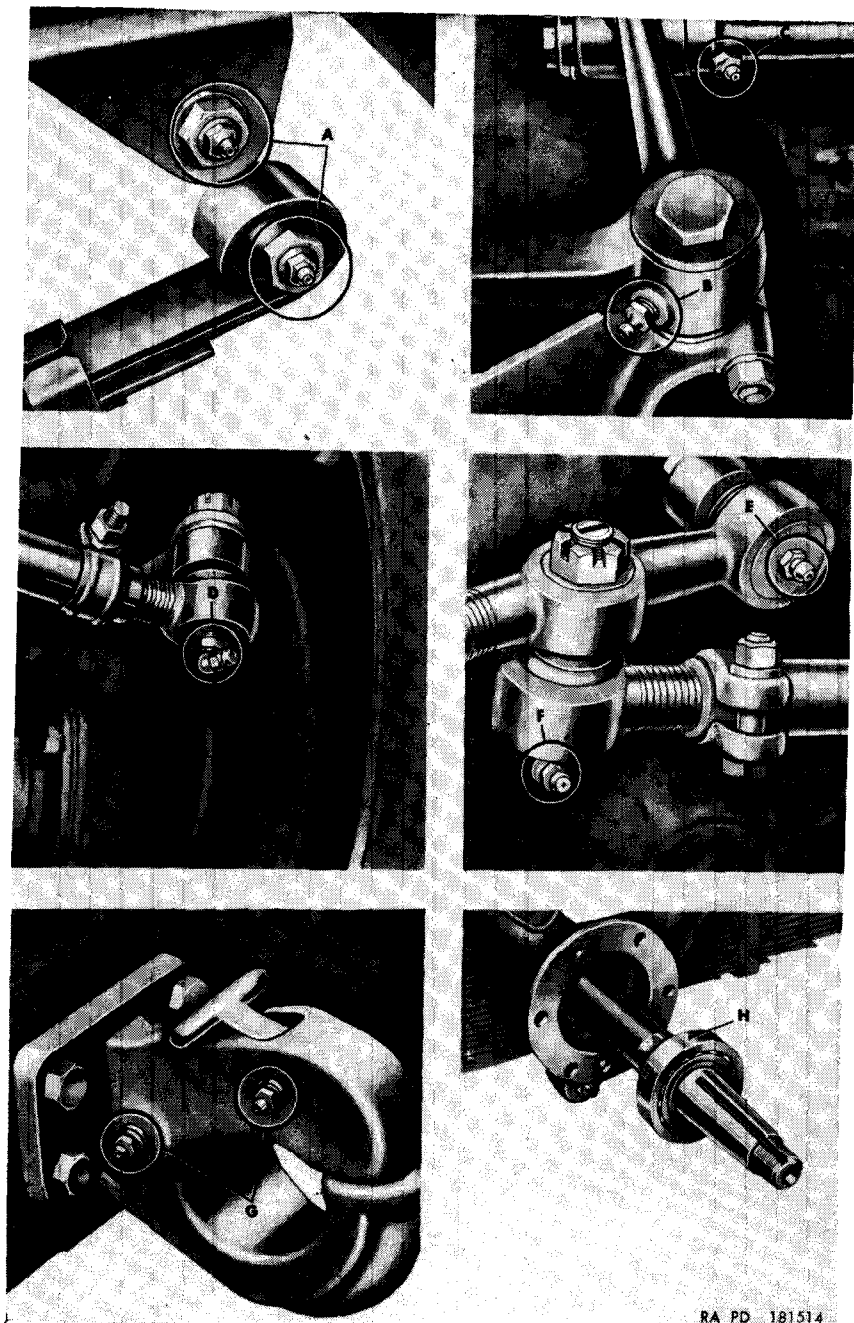
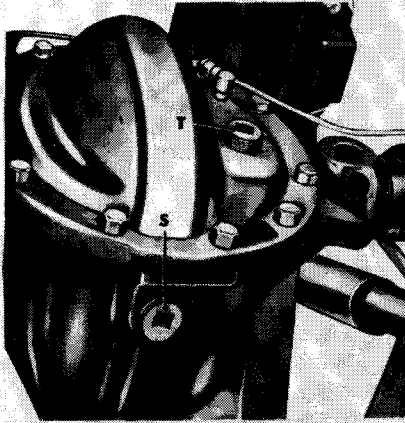
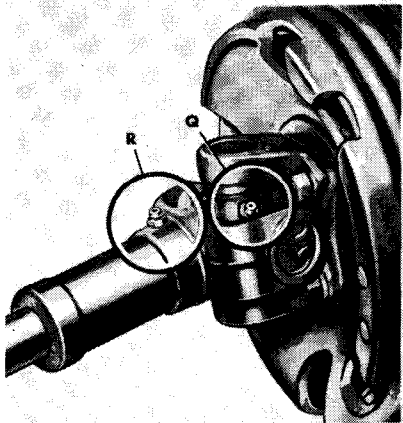
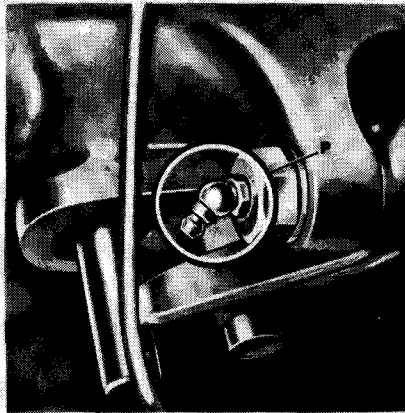
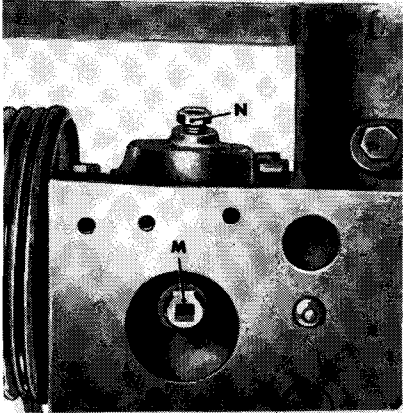
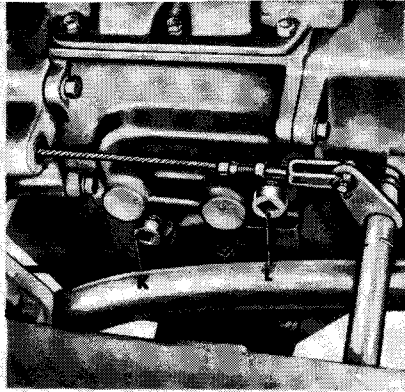
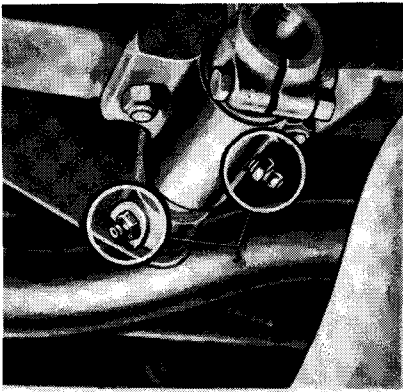
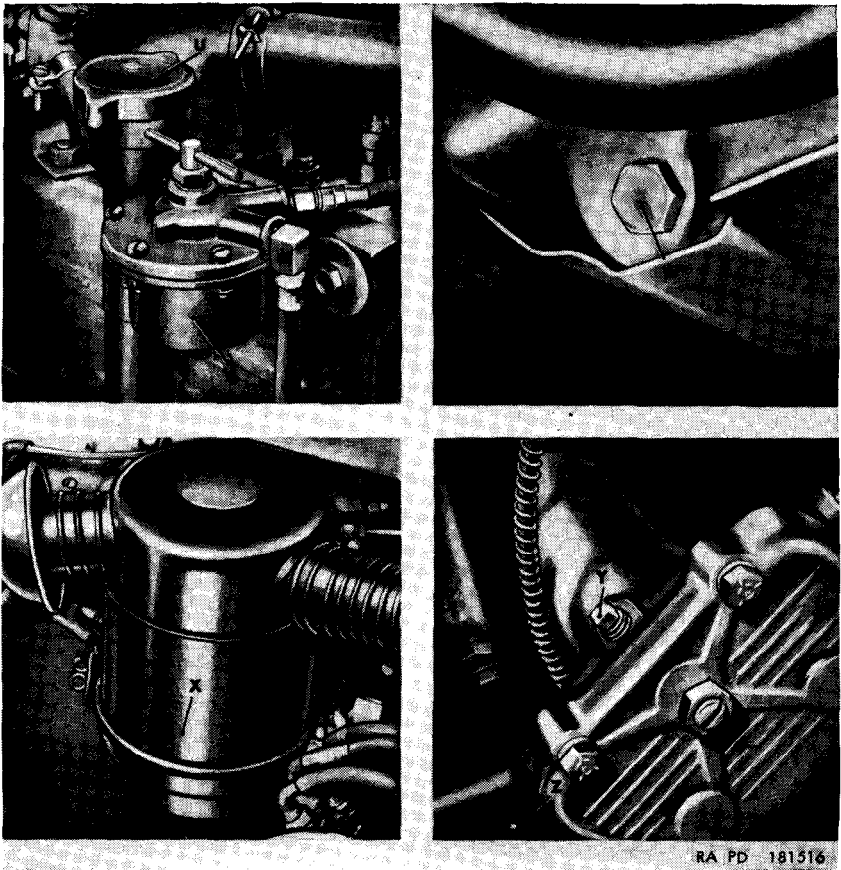

Figure 16. Localized lubrication points A through H.



RA PD 181515

Figure 17. Localized lubrication points J through T.



RA PD 181516

Figure 18. Localized lubrication points U through Z.

No change in grade will be made when a temporary rise in temperature is encountered.

c. Maintaining Proper Lubricant Levels. Lubricant levels must be observed closely and necessary steps taken to replenish in order to maintain proper levels at all times.

69. Lubrication For Continued Operation Below 0° F.

Refer to TM 9-2855 for instructions on necessary special preliminary lubrication of the vehicle, and to TB 9-2855-3 for instructions on installation of the winterization kit.

70. Lubrication After Fording Operations

a. After any fording operation, in water 12 inches or over, lubricate all chassis points to cleanse bearings of water or grit as well as any other points required in accordance with paragraph 275, for maintenance operations after fording.

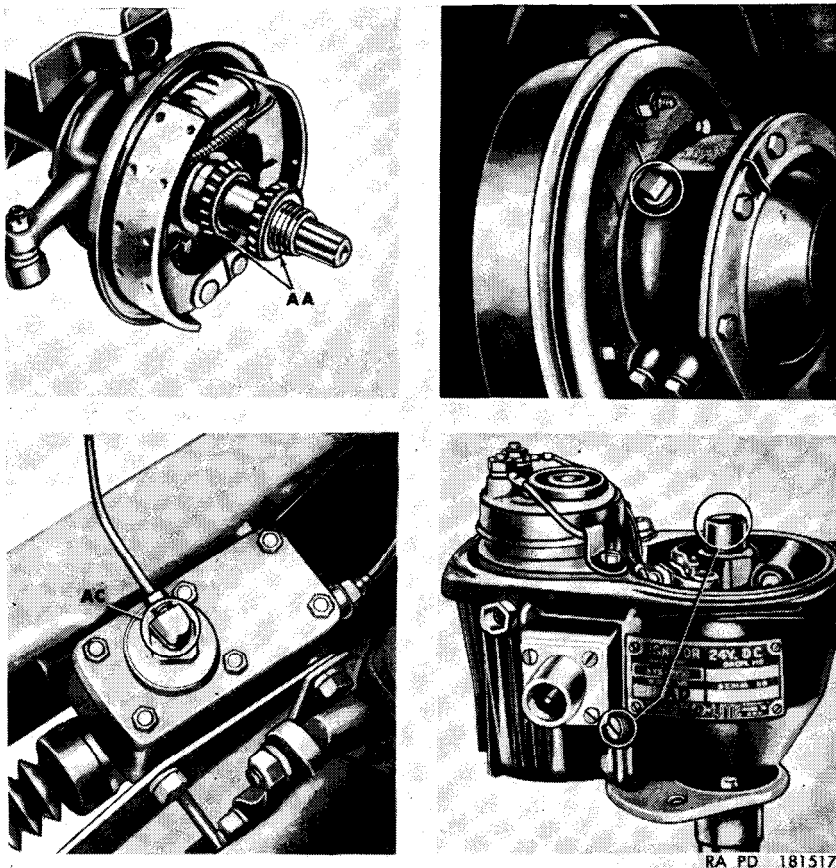

Figure 19. Localized lubrication points AA through AD.

b. If the vehicle has been in deep water for a considerable length of time, or was submerged beyond its fording capabilities, precautions must be taken as soon as practicable to avoid damage to the engine and other vehicle components in (1), (2), and (3) below.

- (1) Perform a complete lubrication service (par. 66).
- (2) Inspect engine crankcase oil. If water or sludge is found, drain the oil and flush the engine with preservative engine oil PE-30. Before putting in new oil, drain the oil filter and perform maintenance operation (par. 111).

Note. If preservative engine oil is not available, engine lubricating oil OE-30 may be used.

- (3) Operation in bodies of salt water enhances the rapid growth of rust and corrosion, especially on unpainted

surfaces. It is most important to remove all traces of salt water or salt deposits from every part of the vehicle or equipment. For assemblies which have to be disassembled, cleaned, dried, and relubricated, perform these operations as soon as the situation permits. Wheel bearings must be disassembled and repacked (par. 67d(3)) after each submersion. Regardless of the temporary measures taken, the vehicle must be delivered as soon as practicable to the ordnance maintenance unit.

71. Lubrication After Operation Under Dusty or Sandy Conditions

After operation under dusty or sandy conditions, clean and inspect all points of lubrication for fouled lubricants and relubricate as necessary. Special attention should be given to the air cleaner and maintenance performed according to lubrication order ("NOTES," fig. 15).

Note. A lubricant which is fouled by dust and sand makes an abrasive mixture that causes rapid wear of parts.

72. Painting

Instructions for the preparation of material for painting, methods of painting, and materials to be used are contained in TM 9-2851. Instructions for camouflage are contained in FM 5-20B. Materials for painting are listed in ORD 7 SNL G-740.

Section III. PREVENTIVE MAINTENANCE SERVICES

73. General

a. Responsibilities and Intervals. Preventive maintenance services are the responsibility of the using organization. These services consist generally of daily operator's services (daily "A" services) performed by the operator or crew, and of biweekly services (biweekly "B" services) performed by the crew (under supervision of the squad, section, and platoon leaders); and of the scheduled services to be performed by organizational maintenance personnel ("C" and "D" services). Intervals are based on normal operations. Reduce intervals for abnormal operations or severe conditions. Intervals during inactive periods may be extended accordingly.

b. Definition of Terms. Inspections to see if items are in good condition, correctly assembled or stowed, secure, not excessively worn, not leaking, and adequately lubricated apply to most items in the preventive maintenance and inspection procedures. Any or

all of these checks that are pertinent to any item (including supporting, attaching, or connecting members) will be performed automatically, as general procedures, in addition to any specific procedures given.

- (1) Inspection for "good condition" is usually visual inspection to determine if the unit is safe or serviceable. "Good condition" is explained further as meaning: not bent or twisted, not chafed or burned, not broken or cracked, not bare or frayed, not dented or collapsed, not torn or cut and not deteriorated.
- (2) Inspection of a unit to see if it is "correctly assembled or stowed" is usually a visual inspection to see if the unit is in its normal position in the vehicle and if all its parts are present and in their correct relative positions.
- (3) Inspection of a unit to see if it is "secure" is usually a visual, hand-feel, pry-bar, wrench, or screwdriver inspection for looseness in the unit. This inspection will include any brackets, lockwashers, locknuts, locking wires, and cotter pins as well as any connecting tubes, hoses or wires.
- (4) "Excessively worn" is understood to mean worn beyond serviceable limits, or likely to fail if not replaced before the next scheduled inspection. Excessive wear of mating parts or linkage connections is usually evidenced by too much play (lash or lost motion). It includes illegibility as applied to markings, data and caution plates, and printed matter.
- (5) Where the instruction "tighten" appears in the procedures, it means tighten with a wrench, even if the item appears to be secure.
- (6) Such expressions as "adjust if necessary" or "replace if necessary" are not used in the specific procedures. It is understood that whenever inspection reveals the need of adjustments, repairs, or replacements, the necessary action will be taken.

74. Cleaning

a. General. Any special cleaning instructions required for specific mechanisms or parts are contained in the pertinent section. General cleaning instructions are as shown in (1) through (5) below.

- (1) Nameplates, caution plates, and instruction plates made of steel rust very rapidly. When they are found to be in a rusty condition, they should be thoroughly cleaned and heavily coated with an application of lacquer.

- (2) Use dry-cleaning solvent or volatile mineral spirits to clean or wash grease or oil from all parts of the vehicle.
- (3) A solution of one part grease-cleaning compound to four parts of dry-cleaning solvent or volatile mineral spirits may be used for dissolving grease and oil from engine blocks, chassis, and other parts. Use cold water to rinse off any solution which remains after cleaning.
- (4) After the parts are cleaned, rinse and dry them thoroughly. Apply a light grade of oil to all polished metal surfaces to prevent rusting.
- (5) Before installing new parts, remove any preservative materials, such as rust-preventive compound, protective grease, etc.; prepare parts as required (oil seals, etc.); and for those parts requiring lubrication, apply the lubricant prescribed in the lubrication order (par. 66 and figs. 14 and 15).

b. General Precautions in Cleaning.

- (1) Dry-cleaning solvent and volatile mineral spirits are inflammable and should not be used near an open flame. Fire extinguishers should be provided when these materials are used. Use only in well ventilated places.
- (2) These cleaners evaporate quickly and have a drying effect on the skin. If used without gloves, they may cause cracks in the skin or a mild irritation or inflammation.
- (3) Avoid getting petroleum products, such as dry-cleaning solvent, volatile mineral spirits, engine fuels, or lubricants on rubber parts as they will deteriorate the rubber.
- (4) The use of diesel fuel oil, gasoline, or benzene (benzol) for cleaning is prohibited.

75. Preventive Maintenance by Driver or Operator(s)

a. Purpose. To insure efficient operation, it is necessary that the vehicle be systematically inspected at intervals every day it is operated and also biweekly, so defects may be discovered and corrected before they result in serious damage or failure. Certain scheduled maintenance services will be performed at these designated intervals. Any defects or unsatisfactory operating characteristics beyond the scope of the driver or operator(s) to correct must be reported at the earliest opportunity to the designated individual in authority.

b. Services. Driver or operators preventive-maintenance services are listed in table II. Every organization must thoroughly school its personnel in performing the maintenance procedures for this vehicle as set forth in this manual.

Table II. Driver or Operators Preventive Maintenance Services.

Before-operation	Intervals Daily "A"				Procedure
	During-operation	At Halt	After-operation	Biweekly "B"	
X	---	X	X	X	<p>Caution: Place all tags describing condition of vehicle in the driver's compartment in a conspicuous location so they will not be overlooked.</p> <p>Fuel, oil, and water. Check the amount of fuel in the fuel tank (par. 26) and note any indication of leaks. Add fuel if necessary and check the spare fuel containers. Check engine oil level and add oil if necessary. Check coolant level in the cooling system and note any indication of leaks. When water is added (par. 121) during period that antifreeze is in use, a hydrometer test must be made and antifreeze added, if necessary, to provide safe operation to meet lowest anticipated temperatures (TM 9-2855).</p>
X	---	---	---	X	<p>Tires. Gage all tires, including spare, for correct pressure (par. 6a).</p>
X	---	X	X	X	<p>Remove all penetrating objects such as nails or glass. Examine tires for signs of low pressure, abnormal tread wear, cuts or missing valve caps.</p>
X	---	X	X	X	<p>Leaks, general. Look under the vehicle and in engine compartment for indications of fuel, engine oil, gear oil, water or brake fluid leaks.</p>
X	---	---	---	---	<p>Vehicle equipment. Visually inspect fire extinguishers and make sure vehicle publications and necessary forms are present and in good condition.</p>
X	---	---	X	X	<p>See that fire extinguishers are charged.</p> <p>Operate lights, horn (if tactical situation permits), and windshield wipers. Visually inspect mirrors, reflectors, lights, body, towing connections, paulins, tools, etc.</p>
X	X	---	---	---	<p>Check for any tampering or damage that may have occurred since last inspection.</p> <p>Instruments. Observe for normal readings during warm-up and during operation of vehicle.</p>
X	---	---	---	---	<p>Caution: If oil pressure is zero or excessively low, stop engine immediately and investigate cause (par. 78l).</p> <p>General operations. Be alert for any unusual noises or improper operation of steering, clutch, brakes, or gear shifting.</p>

Intervals Daily "A"					Procedure
Before- operation	During- operation	At Halt	After- operation	Biweekly "B"	
		X	X	X	<i>Operating faults.</i> Investigate and correct or report any faults noted during operation.
		X	X	X	<i>Springs and suspensions.</i> Look at springs and shock absorbers to see if they have been damaged.
			X		<i>Oil filter.</i> On Cuno-type filter, turn the handle one complete turn. Check filter for leaks.
				X	Remove drain plug and drain sediment.
			X	X	<i>Lubricate.</i> Lubricate items specified on lubrication order (par. 66).
			X	X	<i>Clean.</i> Clean glass vision devices and inside of vehicle. Wipe off exterior of vehicle.
				X	Wash vehicle, clean engine and engine compartment.
				X	<i>Battery.</i> Clean, check water level, inspect terminals for corrosion, tightness, and coating of grease (TM 9-2857).
				X	<i>Assemblies and belts.</i> Inspect assemblies such as carburetor, generator, starter, coil, distributor, water pump, and hose for loose connections or mountings. Check adjustment of drive belts (par. 123).
				X	<i>Electrical wiring.</i> Check all accessible electrical wiring, conduits, and shielding to see that it is securely connected and in good condition.
				X	<i>Axle and transfer vents.</i> Inspect for clogging.

76. Preventive Maintenance by Organizational Maintenance Mechanics

a. Intervals. The indicated frequency of the prescribed preventive-maintenance services is considered a minimum requirement for normal operation of vehicle. Under unusual operating conditions, such as extreme temperatures, dust or sand, or extremely wet terrain, it may be necessary to perform certain maintenance services more frequently.

b. Driver or Operator Participation. The drivers or operators should accompany vehicle and assist the mechanics while periodic organizational preventive-maintenance services are performed. Ordinarily, the driver should present the vehicle for scheduled preventive-maintenance service in a reasonably clean condition.

c. *Special Services.* These are indicated by the item numbers in the columns which show the interval at which the services are to be performed, and show that the parts or assemblies are to receive certain mandatory services. For example, an item number in one or both columns opposite a "Tighten" procedure means that the actual tightening of the object must be performed. The special services are as shown in (1) through (5) below.

- (1) *Adjust.* Make all necessary adjustments in accordance with instructions contained in the pertinent section of this manual, information contained in changes to the subject publication, or technical bulletins.
- (2) *Clean.* Clean the unit as outlined in paragraph 74 to remove old lubricant, dirt, and other foreign material.
- (3) *Special lubrication.* This applies either to lubrication operations that do not appear on the vehicle lubrication order (par. 66) or to items that do appear but which should be performed in connection with the maintenance operations if parts have to be disassembled for inspection or service.
- (4) *Service.* This usually consists of performing special operations, such as replenishing battery water, draining and refilling units with oil, and changing or cleaning the oil filter, air cleaner, or cartridges.
- (5) *Tighten.* All tightening operations should be performed with sufficient wrench torque (force on the wrench handle) to tighten the unit according to good mechanical practice. Use a torque-indicating wrench where specified. Do not overtighten, as this may strip threads or cause distortion. Tightening will always be understood to include the correct installation of lockwasher, locknuts, locking wire, or cotter pins to secure the tightened nut.

d. *Special Conditions.* When conditions make it difficult to perform the complete preventive maintenance procedures at one time, they can sometimes be handled in sections. Plan to complete all operations within the week if possible. All available time at halts and in bivouac areas must be utilized, if necessary, to assure that maintenance operations are completed. When limited by the tactical situation, items with special services in the columns should be given first consideration.

e. *DA Form 461.* The numbers of the preventive maintenance procedures that follow are identical with those outlined on DA Form 461, Preventive Maintenance Service and Inspection for

Wheeled and Half-Track Vehicles. Certain items on the form that do not apply to this vehicle are not included in the procedures in this manual. In general, the sequence of items on the form is followed, but in some instances there is deviation for conservation of the mechanic's time and effort.

f. *Procedures.* Table III lists the services to be performed by the organizational mechanic or maintenance crew at the designated intervals. Each page of the table has two columns at its left edge for designated intervals of every 1,000 miles ("C" service) and 6,000 miles or 6 months whichever occurs first ("D" service). Very often it will be found that a particular procedure does not apply to both scheduled intervals. In order to determine which procedure to follow, look down the column corresponding to the maintenance procedure and wherever an item number appears, perform the operations indicated opposite the number.

Table III. Organizational Mechanic or Maintenance Crew "C" and "D" Preventive Maintenance Services.

Interval		Procedure
"C" (every 1,000 miles)	"D" (6 months or 6,000 miles whichever occurs first)	
		INSPECTION AND ROAD TEST
		<i>Note.</i> When the tactical situation does not permit a full road test, perform only those items that require little or no movement of the vehicle.
		BEFORE OPERATION: <i>Fuel, oil, water, anti-freeze, tires, instruments, leaks general visual inspection of vehicle and equipment.</i> Perform the before-operation services listed in table II.
1	1	<i>Dash instruments, switches, and gages, oil pressure, ammeter, speedometer, temperature, fuel, ignition switch, and other controls.</i> Note generator output on the ammeter immediately after starting engine, before generator regulator has reduced the charging rate. Observe all instruments for normal readings. Notice if ignition switch operates freely and makes positive contact, and check all other controls for normal operation (figs. 7 and 11).
2	2	<i>Horns, mirrors, and windshield wipers.</i> Sound horn to see if signal is normal (if tactical situation permits). Test windshield wipers for satisfactory operation. Examine mirrors and reflectors.

Interval		Procedure
"C" (every 1,000 miles)	"D" (6 months or 6,000 miles whichever occurs first)	
3	3	INSPECTION AND ROAD TEST—Con. <i>Engine-idle, acceleration, power, noise.</i> In warming up the engine, observe if it starts easily and if action of choke control and throttle control (CC and BB, fig. 7) are satisfactory. Notice if idling speed is correct. Listen for any unusual noises at idle and higher speeds. When operating the vehicle, notice if it has normal power and acceleration in each speed. Listen for any unusual noises when the engine is under load.
4	4	<i>Steering-free play, bind, wander, shimmy, side pull, jacket and wheel</i> (par. 99). With the vehicle moving straightahead, see if the steering wheel has excessive free play and if there is any tendency to wander, shimmy, or pull to the side. Turn the steering wheel through its entire range and note any bind. Examine steering gear jacket and wheel.
5	5	<i>Clutch-free travel, drag, noise, chatter, grab, slip.</i> See if clutch pedal has specified free travel (par. 196) and if action of pedal return spring is satisfactory. Note whether clutch disengages completely or has a tendency to drag. Observe smoothness of engagement and tendency to chatter, grab, or slip and any unusual noise. With transmission in neutral, depress and release clutch pedal (EE, fig. 7) listening for defective release bearing.
7	7	<i>Brakes (service and hand)—braking effect, feel, side pull, noise, chatter, pedal travel and hand control</i> (pars. 95 and 96). See if brake pedal has specified free travel and if action of return spring is satisfactory. Observe if pedal goes too close to floor. Make several stops noting side pull, noise, chatter, or any other unusual conditions. Observe if ratchet of hand brake holds and if the handle requires more than three-quarters travel for full application. Stop the vehicle on an incline and apply the hand brake to see if it holds the vehicle or if application of hand brake at a speed of 10 mph stops the vehicle within a reasonable distance.

Interval		Procedure
"C" (every 1,000 miles)	"D" (6 months or 6,000 miles whichever occurs first)	
8	8	<p>INSPECTION AND ROAD TEST—Con.</p> <p><i>Generator starter and switch</i>—action, noise, speed (pars. 82 and 83). Notice if the starter switch requires only normal pressure, and if the starter engages smoothly without unusual noise and turns the engine with adequate cranking speed. Examine generator brushes and clean commutator.</p>
9	9	<p><i>Transmission and transfer</i>—lever action, de-clutching, vibration, noise. Shift transmission and transfer into all speeds, observing any unusual stiffness of the shift levers, tendency to slip out of speed, unusual noise, or excessive vibration. Make similar observations with transfer front wheel drive gearshift lever (par. 47).</p>
10	10	<p><i>Unusual noises</i>—attachments, body and wheels, power train. At all times during the road test, be alert for unusual or excessive noises that might indicate looseness, defects, or deficient lubrication in these components.</p>
11	11	<p><i>Lamps</i>—head, tail, body, running, stop, and blackout. During stops in the road test, test the operation of these exterior and interior lights and light switches. Notice if headlights appear to be properly aimed (figs. 71 and 73). Note condition of lights and safety reflectors.</p>
25	25	<p>AFTER ROAD TEST</p> <p><i>Temperatures</i>—brake drums, hubs, axles, transmission, transfer, and differentials. Immediately after the road test, feel these units cautiously. An overheated wheel hub and brake drum indicates an improperly adjusted, defective, or dry wheel bearing or a dragging brake. An abnormally cool condition indicates an inoperative brake (par. 95). An overheated gear case indicates internal maladjustment, damage, or lack of lubrication (par. 66).</p> <p><i>Note.</i> It is normal for hypoid rear axles to run quite hot after the vehicle has run a considerable distance. If these particular units are too hot for the hand to be placed upon them, it is not necessarily a sign of malfunctioning. If they are adequately lubricated and did not howl during the road test, assume they are all right.</p>

Interval		Procedure
"C" (every 1,000 miles)	"D" (6 months or 6,000 miles whichever occurs first)	
		AFTER ROAD TEST—Continued
	25	Inspect propeller shafts (figs. 91 and 92). Tighten universal joint assembly and flange units (par. 92).
26	26	<i>Leaks—engine oil, fuel, water, axles, housings, transmission, transfer and all other components carrying fluids, oil, or grease.</i> Make general observations in the engine compartment and underneath the vehicle for oil, water, fuel, and exhaust leaks. Look at spark plug, manifold, and cylinder head gaskets. Caution: Do not tighten the cylinder head or manifold unless there is evidence of looseness or leakage. If cylinder head requires tightening, use a torque indicating wrench and tighten in the sequence (fig. 25) and to the torque specified in paragraph 103.
27	27	<i>Lubrication—lubricate vehicle in accordance with lubrication order (par. 66).</i> Coordinate with inspection and disassembly operations to avoid duplication.
27	27	During lubrication, inspect tires for unusual wear, penetrating objects, and proper matching.
	27	Rotate and match tires according to tread design and degree of wear (par. 255). See TM 31-200 for acceptable limits in matching tires. Tighten axle flange nuts.
		MAINTENANCE OPERATION
28	28	<i>Battery—specific gravity.</i> Make hydrometer test of electrolyte in each cell (TM 9-2857) and record specific gravity in space provided on DA Form 461.
29	29	<i>Battery—voltage.</i> Perform a high-rate discharge test according to instructions in TM 9-2857 or accompanying test instrument. Record voltage of each cell in space provided on DA Form 461.
	29	After battery test, clean top of battery, coat terminals lightly with grease, repaint carrier if corroded. Look to see if battery requires water. <i>Note.</i> If distilled or approved water is not available, clean water, preferably rain water, may be used.

Interval		Procedure
"C" (every 1,000 miles)	"D" (6 months or 6,000 miles whichever occurs first)	
		MAINTENANCE OPERATION—Continued
	30	<i>Compression.</i> Test compression in each cylinder (par. 78b (9)), with throttle and choke wide open, and record in space provided on DA Form 461. It is preferable to make compression test with engine at operating temperature.
	31	<i>Air cleaner, crankcase ventilator and control valve.</i> Clean and inspect air cleaner, crankcase ventilator, and control valve (par. 107).
	31	Clean and service these items in accordance with the lubrication order (par. 66), or instructions in the pertinent section of this manual.
	32	<i>Radiator—core, shell, hose, cap, and gasket.</i> Inspect these items, noticing particularly if the radiator core is clogged with foreign matter or if fins are bent. Test the operation of the pressure cap. Observe coolant level (par. 121) and examine coolant for contamination. In cold weather, test coolant with a hydrometer to see if it contains sufficient antifreeze.
	32	If need is indicated, drain radiator and block (fig. 40), clean, flush, refill (par. 121), and add rust inhibitor, unless antifreeze, which contains inhibitor, is used. Tighten radiator mountings and hose clamps.
	33	<i>Water pump, fan, drive belts, and pulleys</i> (fig. 39). Inspect pulleys and fan for alignment and drive belts for proper tension (par. 123 and fig. 42). Notice if water pump is leaking.
	34	<i>Valve mechanism—clearance, cover gaskets.</i> Gage intake and exhaust valve tappet clearance (par. 105) and look for broken or weak valve springs if need is indicated by engine performance, low compression, or tappet noise. If clearance is found incorrect, adjust (par. 105), and recheck engine compression (par. 78b (9)). Inspect cover gaskets.

Interval		Procedure
"C" (every 1,000 miles)	"D" (6 months or 6,000 miles whichever occurs first)	
		MAINTENANCE OPERATION—Continued
	35	<i>Spark plugs—clean and adjust, distributor, cap, rotor, points, shaft, advance unit, coil and wiring, ignition timing.</i> Remove and inspect spark plugs (par. 145). Inspect distributor cap, rotor, and breaker points and test operation of centrifugal and vacuum advance mechanism by hand. Test distributor shaft for looseness by hand feel. Test ignition coil and distributor capacitor with high-tension ignition-circuit tester, if available, according to instructions accompanying the test instrument. Using neon timing light, observe if ignition timing (figs. 58 and 59) is correct (par. 142) and if spark advances automatically as engine is accelerated. Test generator regulator with a low-voltage circuit tester following instructions accompanying the test instrument.
	35	Clean spark plugs and adjust gaps (par. 145). Check distributor breaker points and adjust gap (par. 143), (figs. 57 and 61). If points are badly pitted, replace both points and capacitor.
	36	<i>Manifold and heat control.</i> Inspect these items. Look particularly for signs of leakage at manifold gaskets. If heat control is automatic, see if shaft operates freely and if bimetal spring controls it properly. If it is manually controlled, check seasonal adjustment.
37	37	<i>Carburetor, choke, throttle, linkage fuel filter and lines.</i> Inspect these items noticing particularly if the shafts and linkage operate freely and are not excessively worn. Observe if the choke valve plate opens fully when the choke control is released and if the throttle valve plate opens fully when the accelerator is fully depressed.
	37	Make an engine vacuum test (par. 79c(6)), and adjust carburetor idle mixture (par. 129). Test fuel pump pressure (par. 79b(2)).

Interval		Procedure
"C" (every 1,000 miles)	"D" (6 months or 6,000 miles whichever occurs first)	

Interval		Procedure
"C" (every 1,000 miles)	"D" (6 months or 6,000 miles whichever occurs first)	
		MAINTENANCE OPERATION—Continued
	37	Examine fuel lines and connections for evidence of leaks. Clean the filter element of fuel filter; drain water and sediment from fuel tank if there is evidence of contamination, using a container to catch the drainings.
	38	<i>Exhaust pipe and muffler.</i> Inspect; listen for excessive or unusual noises and look for exhaust leaks.
	38	Tighten mountings.
	39	<i>Brakeshoes—linings, links, guides, anchors, supports, cylinders, cams, hose, and lines.</i> Inspect flexible and rigid brake lines and test brake linkage for freedom of action.
	39	Remove wheels (par. 256a) and brake drums (par. 242d(3) and e(3)) and examine drums, shoes, linings, guides, anchors, supports, retractor springs, and cylinders and cams.
	39	Wheel bearings will be disassembled, cleaned and repacked (pars. 215a and c, 225b and d, and 67) in every second 6,000 mile inspection or annually. If the wheel bearings are due for repacking, remove wheels and hubs and make observations of the brake internal components as in the preceding paragraph. Clean the anchor plates and tighten the anchor-plate bolts. If the wheel bearings are not due for repacking, inspect the internal brake components only on vehicles from which the brake drum can be removed without removing the hubs and bearings. Adjust brakes (par. 242). If wheels have not been disassembled from brake drums, tighten wheel nuts.
	40	<i>Body—hardware, glass, top and frame, curtains and fasteners, seats, upholstery, trim, safety straps, and paint.</i> Inspect these items, paying particular attention to body mountings and springs. Test operation of windshield, hood hinges, and fasteners. Observe seat mountings and upholstery. Make a general inspection of the body including glass, panels, tops, fenders, running boards, chains, bows,

Interval		Procedure
"C" (every 1,000 miles)	"D" (6 months or 6,000 miles whichever occurs first)	
		MAINTENANCE OPERATION—Continued
	40	Tighten body mounting bolts. Loosen the steering gear jacket clamp before tightening body mounting bolts and tighten afterward. Tighten spring U-bolts and spring leaf clips.
	42	<i>Bumpers—front and rear, and towing pintle.</i> Inspect these items including lifting shackles. Test operation of towing pintle (fig. 10).
	44	<i>Winch—power-take-off.</i> Inspect power-take-off and winch drive lines (pars. 54 and 202). Test operation of winch. Clean and oil winch cable in accordance with lubrication order (par. 66).

Section IV. TROUBLESHOOTING

77. Scope

a. This section contains troubleshooting information and tests for locating and correcting some of the troubles which may develop in the vehicle. Troubleshooting is a systematic isolation of defective components by means of an analysis of vehicle trouble symptoms; testing to determine the defective component and applying the remedies. Each symptom of trouble given for an individual unit or system is followed by a list of probable causes of the trouble and suggested procedures to be followed.

b. This manual cannot cover all possible troubles and deficiencies that may occur under the many conditions of operation. If a specific trouble, test, and remedy therefor are not covered herein, proceed to isolate the system in which the trouble occurs and then locate the defective component. Do not neglect use of any test instruments such as voltmeter, ammeter, test lamp, hydrometer, and pressure and vacuum gages that are available. Standard automotive theories and principles of operation apply in troubleshooting the vehicle. Question vehicle driver or operator to obtain maximum number of observed symptoms. The greater

the number of symptoms of troubles that can be evaluated, the easier will be the isolation of the defect.

78. Engine

a. *Engine Will Not Turn.*

- (1) *Weak or discharged batteries.* Test batteries and replace if necessary (par. 155).
- (2) *Loose battery ground cable.* Clean and tighten battery ground cable (par. 155).
- (3) *Loose or corroded battery terminals.* Clean and tighten battery terminals (par. 155).
- (4) *Faulty starter switch.* Refer to paragraph 82.
- (5) *Faulty starter.* Refer to paragraph 82.
- (6) *Incorrect oil viscosity.* Inspect engine oil. Check records of oil changes and if found to be improper grade, drain and refill with correct grade of engine oil (par. 66).
- (7) *Mechanical seizure of engine parts.* Refer to ordnance maintenance personnel.

b. *Engine Turns But Will Not Start.*

- (1) *Lack of fuel.* Check fuel gage on instrument panel with ignition switch turned on, and also check actual level in fuel tank to be sure there is sufficient fuel for operation and that fuel gage is operative.
- (2) *Engine is wet.* Although engine is waterproofed, it is possible for moisture to collect due to seepage, loose connections, or condensation. Wipe all moisture from distributor terminal housing, distributor cap, coil, and spark plugs.
- (3) *Engine is too hot.* If engine is hot, either vapor lock or "percolation" might exist. Vapor lock is due to the vaporization of fuel before it reaches the carburetor and as a result the engine is starved for fuel. "Percolation" is caused by the fuel vaporizing in the carburetor passages. The bubbles rise, pushing the fuel above them into the carburetor throat. Vapor lock may occur when the vehicle is under load and can slow or completely stop vehicle. "Percolation" occurs only as the engine speed is reduced or when the vehicle is standing and engine is idling. To start a vehicle which has vapor locked or "percolated," press the accelerator pedal to floor board and crank engine until it starts. Do not pump accelerator pedal as this action will cause flooding of the engine.
- (4) *Engine is flooded.* Press accelerator pedal to floor board and crank engine until it starts.

- (5) *Insufficient cranking speed.* Refer to paragraph 82c.
- (6) *Lack of current at spark plugs.* Refer to paragraph 81.
- (7) *Fuel does not reach carburetor.* Refer to paragraph 79.
- (8) *Faulty ignition timing.* Refer to paragraph 142.
- (9) *Poor engine compression.* Perform an engine compression test as follows—remove all spark plugs and spark plug gaskets (par. 145). Block carburetor throttle linkage in open position to assure a full charge of air in the cylinders. With ignition switch off and a compression gage in position in one cylinder (fig. 20), crank engine with starter until compression gage pointer no longer rises. Note compression reading on gage. Reset compression gage to zero after checking each cylinder. Record compression pressure for each cylinder on DA Form 461. Compare the compression pressures of the cylinders. Normal compression pressure is 135 psi. Minimum compression pressure is 100 psi. Cylinder compression pressures should not vary more than 20 psi. If pressures do vary more than 20 psi, or are lower than 100 psi, notify ordnance maintenance personnel.



Figure 20. Checking engine compression.

c. Engine Misfires, But Will Not Start.

- (1) *Spark plug cables transposed at spark plugs.* Check spark plug cables and make sure cables are attached to correct spark plugs (fig. 54).
- (2) *Spark plug cables transposed at distributor cover.* Check spark plug cables at distributor cover and make sure they are in correct positions (fig. 54).
- (3) *Faulty distributor cap.* Remove distributor cap (par. 143) and inspect for cracks or burned contacts. Replace cap if necessary (par. 143).
- (4) *Faulty ignition timing.* Time engine (par. 142).
- (5) *Distributor rotor not properly seated on shaft.* Remove distributor cap (par. 143) and check rotor for proper seating on distributor shaft. Replace rotor if damaged (par. 143).

d. Starts But Fails To Keep Running.

- (1) *Fuel not reaching carburetor.* Refer to paragraph 79a.
- (2) *Unsatisfactory spark being delivered to spark plugs.* Refer to paragraph 81.

e. Runs Unevenly And Backfires Through Carburetor.

- (1) *Shorted or transposed spark plug cables.* Inspect spark plug cables for cracks which would allow cable to short out. Replace spark plug cables if necessary. Check spark plug cables for proper location at distributor cover and at spark plugs.
- (2) *Shorted distributor rotor.* Remove distributor cover (par. 143) and inspect rotor for cracks or evidence of shorting. Replace distributor rotor if necessary (par. 143).
- (3) *Lean fuel mixture.* Adjust carburetor (par. 129).
- (4) *Leaking cylinder head gasket.* Replace cylinder head gasket (par. 103).
- (5) *Faulty engine compression.* Perform an engine compression test (b(9) above).
- (6) *Sticking valves.* Run engine at idle speed and observe if any of the valves are noticeably noisy. Adjust valve clearance if necessary (par. 105).
- (7) *Incorrect spark advance.* Refer to ordnance maintenance personnel.

f. Engine Does Not Develop Full Power.

- (1) *Throttle linkage kinked or damaged.* Examine throttle linkage for kinks or breaks. Press accelerator pedal to floor board and note if throttle opens fully. If replacement of throttle linkage is necessary, notify ordnance maintenance personnel.

- (2) *Choke control linkage kinked or damaged.* Inspect choke control linkage for kinks or breaks. Inspect choke valve plate to see that it is completely open when choke control button on instrument panel is pushed in. Choke control linkage should have enough free play so that normal movement of the engine on its flexible mounts will not cause a partial closing of the choke valve plate.
- (3) *Improper engine compression.* Perform an engine compression test (b (9) above).
- (4) *Fouled or worn out spark plugs.* Remove, clean, and, inspect spark plugs, replace if necessary (par. 145).
- (5) *Weak coil.* Test coil by substitution (par. 81).
- (6) *Insufficient fuel delivered to carburetor.* Refer to paragraph 79.
- (7) *Carburetor flooding.* Refer to paragraph 79.
- (8) *Fuel mixture too rich or lean.* Adjust carburetor (par. 129).
- (9) *Clutch slips.* Adjust clutch pedal free travel (par. 196). If clutch must be replaced, refer to ordnance maintenance personnel.
- (10) *Brakes dragging or tires low.* Adjust brakes (par. 242) and inflate tires to correct pressure (par. 257).
- (11) *Kinked exhaust pipe or exhaust pipe extension.* Replace exhaust pipe or exhaust pipe extension (par. 138).
- (12) *Clogged muffler.* Replace muffler (par. 139).
- (13) *Incorrect wheel alinement.* Adjust toe-in (par. 234).
- (14) *Incorrect oil viscosity.* Inspect engine oil. Check records of oil changes and if found to be improper grade, drain and refill with correct grade of engine oil (par. 66).
- (15) *Tight engine.* If engine has just received major repairs, it may be tight, and top speed and power will be reduced until the new parts are run-in and normal working clearances have been established.
- (16) *Clogged air cleaner or precleaner.* Clean air cleaner and precleaner (par. 132).
- (17) *Restriction in fuel lines.* Inspect fuel lines for kinks or pinches, replace lines if necessary (par. 135).
- (18) *Fuel line air leak.* The fuel line from fuel tank to inlet side of fuel pump is under vacuum when engine is running. If a small air leak is present, it will reduce quantity of fuel being delivered to fuel pump. Inspect fuel line and replace if necessary (par. 135).

g. Engine Misfires On Acceleration Or Hard Pull.

- (1) *Faulty accelerating pump.* Replace carburetor (par. 129).
- (2) *Weak spark at spark plugs.* Refer to paragraph 81.
- (3) *Fouled or worn out spark plugs.* Clean, gap, and inspect spark plugs (par. 145). Replace spark plugs if necessary (par. 145).
- (4) *Faulty compression.* Perform a compression test (b(9) above).
- (5) *Improper valve action.* Run engine at idle speed and observe if any of the valves are noticeably noisy. Adjust valve clearance if necessary (par. 105).

h. Engine Misfires at High Speeds.

- (1) *Faulty ignition system.* Refer to paragraph 81.
- (2) *Incorrect valve adjustment.* Check valve clearances and adjust as necessary (par. 105).
- (3) *Leaking cylinder head gasket.* Replace cylinder head gasket (par. 103).
- (4) *Faulty fuel pump.* Test fuel pump pressure (par. 79). Replace fuel pump if necessary (par. 131).
- (5) *Carburetor improperly adjusted or faulty.* Adjust carburetor (par. 129a). If condition is not improved, replace carburetor (par. 129).

i. Engine Does Not Idle Properly.

- (1) *Incorrect idle speed adjustment.* Refer to paragraph 129.
- (2) *Incorrect idle fuel adjustment.* Refer to paragraph 129.
- (3) *Fouled or worn out spark plugs.* Clean, adjust, and inspect spark plugs. Replace spark plugs if necessary (par. 145).
- (4) *Faulty ignition.* Refer to paragraph 81.
- (5) *Faulty ignition timing.* Time engine (par. 142).
- (6) *Loose connection in ignition primary circuit.* Tighten all connections in ignition primary circuit.

j. Excessive Oil Consumption.

- (1) *Engine overheats.* Refer to b(3) above and paragraph 85.
- (2) *Leaks.* Inspect engine, engine compartment, and ground beneath engine for indications of oil leakage. Tighten any leaking connections, repair or replace broken oil lines, or notify ordnance maintenance personnel.
- (3) *Poor engine compression.* Refer to b(9) above.
- (4) *Engine oil level too high.* Maintain proper oil level. Oil level may be raised by fuel being forced into crankcase past carburetor needle valve, through primer pump, or

around fuel pump diaphragm when the pressure relief valve in the fuel tank fails and pressure in the tank is built up at high temperatures. Check for odor of gasoline on dipstick. Check relief valve (par. 127a).

- (5) *Improper grade and viscosity of engine oil.* Inspect engine oil. Check records of oil changes and if found to be improper, drain and refill with correct grade of engine oil (par. 66).
- (6) *Excessive high speeds.* Avoid unnecessary and excessive speeds.
- (7) *Excessive low-gear driving.* Operate vehicle in proper gear for desired speed and terrain (par. 45).

k. Engine Overheats. Refer to *b(3)* above and paragraph 85.

l. Low Oil Pressure. Inspect engine oil level and refill as directed on lubrication order (par. 66) if necessary. If trouble is not corrected by filling crankcase, piston rings, or connecting rod bearings, or crankshaft bearings are worn, refer to ordnance maintenance personnel.

79. Fuel and Air Intake System

a. Fuel Not Reaching Carburetor.

- (1) *Fuel and vacuum pump or fuel line leaks.* Inspect fuel and vacuum pump for evidence of leakage. Tighten all connections. Inspect fuel lines for evidence of leaks. Replace lines if necessary (par. 135).
- (2) *Engine overheats.* Refer to *b(3)* above and paragraph 85.
- (3) *Inoperative fuel and vacuum pump.* Remove fuel line from inlet side of carburetor. With ignition switch in OFF position, crank engine and observe action of fuel pump. If fuel spurts from fuel line, the fuel and vacuum pump is operative. If no fuel is observed spurting from fuel line, the fuel and vacuum pump is faulty and should be modified or replaced (par. 131).

Caution: Provide container for fuel, as this is a fire hazard.

b. Carburetor Floods.

- (1) *Faulty carburetor choke action.* Remove air cleaner, operate choke, and observe if carburetor choke valve opens freely. If choke action is faulty, adjust choke linkage.
- (2) *Improper fuel pump pressure.* Disconnect fuel line from outlet side of fuel and vacuum pump. Install a pressure gage (fig. 21) in fuel and vacuum pump outlet.

With ignition switch in OFF position, crank engine until pointer on pressure gage no longer rises. Observe reading on pressure gage. Fuel and vacuum pump pressure is normally $4\frac{1}{2}$ to 5 psi. If pressure is not correct, replace pump (par. 131). If new pump gives incorrect pressure, notify ordnance maintenance personnel.

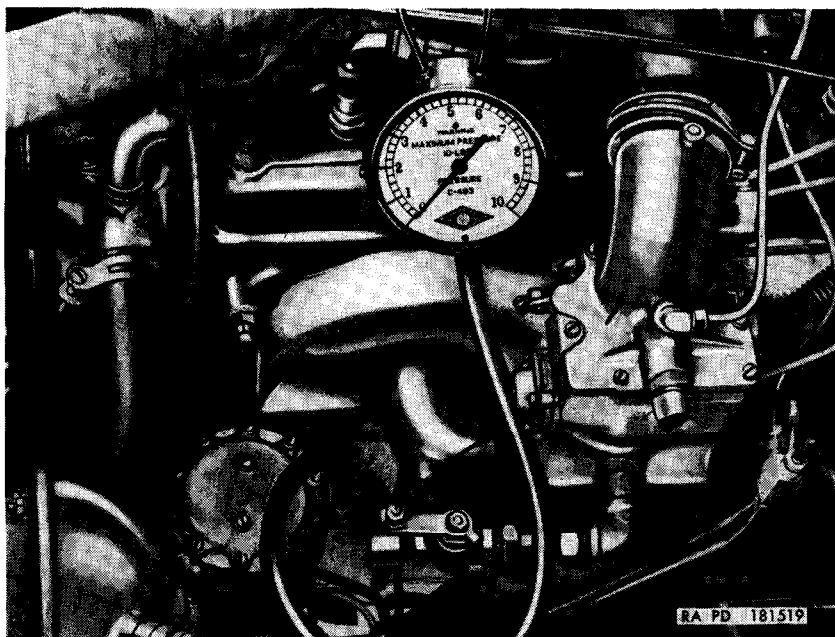

Figure 21. Testing fuel and vacuum pump pressure.

- (3) *Faulty carburetor.* Replace carburetor (par. 129).
- c. *Fuel Mixture Too Lean.*
- (1) *Incorrect carburetor adjustment.* Adjust carburetor (par. 129).
 - (2) *Leaky fuel lines.* Inspect fuel lines and fittings. Replace lines or fittings if necessary (par. 135).
 - (3) *Obstruction in fuel lines.* Disconnect fuel line at inlet side of fuel and vacuum pump. Remove fuel tank filler cap, and blow compressed air back through fuel line to remove any obstructions.
 - (4) *Faulty fuel pump.* Perform fuel and vacuum pump test (b(2) above). Replace fuel and vacuum pump if necessary (par. 131).
 - (5) *Faulty carburetor.* Replace carburetor (par. 129).

(6) *Faulty engine vacuum.* Perform engine vacuum test as follows—disconnect fuel and vacuum pump vacuum line at elbow located on exhaust manifold, and install vacuum gage adapter in elbow (fig. 22). Start engine and run at idling speed until minimum operating temperature (160° F.) is reached. Make sure the carburetor is adjusted properly. Adjust if necessary (par. 127). With engine operating at normal idling speed, vacuum gage should show a reading of 18 to 21 inches of mercury. A pointer fluctuating between 10 and 15 inches of mercury may indicate a leaking valve or defective cylinder-head gasket. An abnormally low reading with the pointer steady may indicate a leak at the carburetor. Accelerate and decelerate engine rapidly. Vacuum should drop to approximately 2 inches of mercury with rapid acceleration, and should rise to 24 inches of mercury as acceleration is decreased quickly.

Note. Above readings are for sea level operation. Vacuum readings will be lowered approximately 1 inch of mercury for 1,000 feet increase in altitude.

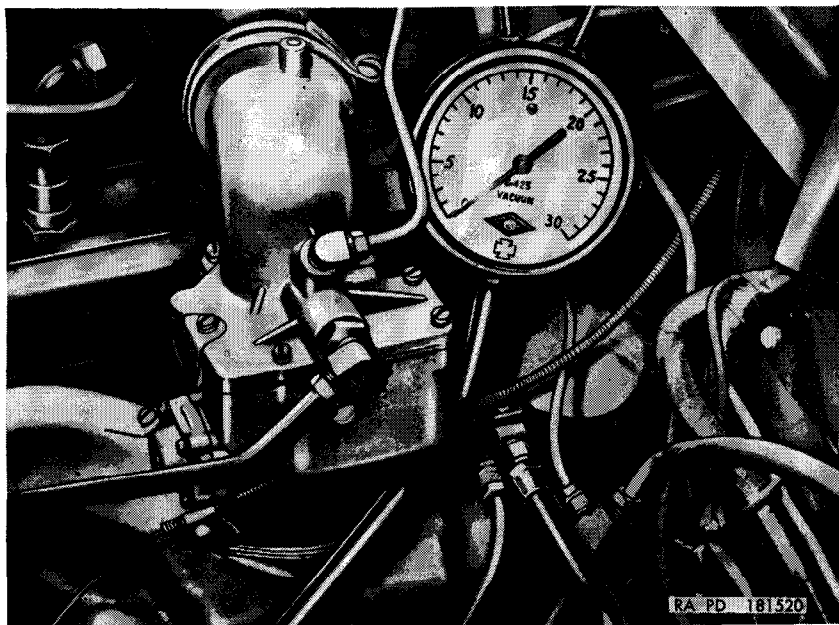

Figure 22. Testing engine vacuum.

d. Fuel Mixture Too Rich.

(1) *Incorrect carburetor adjustment.* Adjust carburetor (par. 129).

- (2) *Fouled air cleaner.* Clean air cleaner (par. 132).
- (3) *Choke valve plate not fully open.* Remove air cleaner and observe if choke valve plate is fully open. Make sure choke linkage has enough free play so that normal movement of the engine on its flexible mounts will not cause a partial closing of the choke valve plate.
- (4) *Improper fuel pump pressure.* Refer to *b*(2) above.
- (5) *Faulty carburetor.* Replace carburetor (par. 129).

e. Excessive Fuel Consumption.

- (1) *Dragging brakes.* Adjust brakes (par. 242).
- (2) *Incorrect tire inflation.* Inflate tires to correct pressure (par. 254).
- (3) *Kinked exhaust pipe or exhaust pipe extension.* Replace exhaust pipe or exhaust pipe extension (par. 138).
- (4) *Clogged muffler.* Replace muffler (par. 139).
- (5) *Incorrect toe-in.* Adjust toe-in (par. 234).
- (6) *Incorrect spark plug gap.* Remove, clean, and adjust spark plugs (par. 145).
- (7) *Faulty ignition.* Refer to paragraph 81.
- (8) *Faulty ignition timing.* Time ignition (par. 142).
- (9) *Fouled air cleaner.* Clean air cleaner (par. 132).
- (10) *Poor engine compression.* Perform an engine compression test (par. 78b(9)).
- (11) *Incorrect fuel pump pressure.* Perform a fuel pump pressure test (*b*(2) above).
- (12) *Faulty carburetor.* Adjust or replace carburetor (par. 129).
- (13) *Brakes dragging when hot.* Make sure brake pedal has necessary free travel (par. 242).
- (14) *Too little or too much valve clearance.* Adjust valve clearance (par. 105).

80. Exhaust System

a. Excessive Noise.

- (1) *Broken or split muffler.* Replace muffler (par. 139).
- (2) *Leaking intake and exhaust manifold gasket.* A leaking intake and exhaust manifold gasket may be noted by carbon streaks on the cylinder block around the manifold or by the rush of exhaust gases felt against the hand. Tighten exhaust manifold or replace manifold gasket (par. 109).
- (3) *Broken, split, or pinched exhaust pipe or exhaust pipe extension.* Replace exhaust pipe or exhaust pipe extension (par. 138).

b. *Odor of Exhaust Fumes in Driver's Compartment.* Leak in exhaust system. Replace defective parts (a above).

Warning: Replace defective exhaust system parts immediately, as exhaust gas (carbon monoxide) is poisonous.

81. Ignition System

a. *No Spark (Ammeter Registers Zero When Ignition Switch Is Turned On).*

- (1) *Low or faulty batteries.* Test batteries (TM 9-2857) and, if excessively low, replace (par. 155).
- (2) *Loose or corroded battery cables.* Clean cable terminals and tighten bolts (par. 155).
- (3) *Faulty ignition switch.* Check ignition switch circuit with suitable test equipment or replace old switch (par. 181) with one known to be operating. If, with switch on, ammeter now registers a slight discharge, old ignition switch was faulty.
- (4) *Faulty ammeter.* Check ammeter circuit with suitable test equipment or replace old ammeter (par. 174) with one known to be operating. If, with ignition switch on, ammeter now registers a slight discharge, old ammeter was faulty.
- (5) *Broken primary circuit from ignition switch to ignition coil or from ignition coil to distributor.* An ammeter reading of zero while ignition switch is turned on and engine is being cranked indicates that no current is flowing in the primary circuit.
 - (a) With ignition switch in OFF position, disconnect cable at battery side of ammeter and use test light or low voltage circuit tester to determine if current is flowing. If current is not flowing to the ammeter, check connection and cable for looseness or breaks.
 - (b) Check wiring circuit for signs of looseness or breaks from ammeter to ignition switch, and through ignition switch, with switch turned off. Replace cables if faulty. Clean and tighten all connections.
 - (c) Check wiring circuit for signs of looseness or breaks through primary cable from ignition switch to ignition coil and from coil to distributor. If current flows through primary cable from ignition switch to ignition coil, but not from ignition coil to distributor, replace coil (par. 144). If current flows through primary cable and ignition coil to the distributor, the trouble lies within the distributor.

- (d) If breaker points are faulty, remove distributor cover and distributor cap (par. 143) and inspect breaker points for burned or pitted contact surfaces. Replace points if necessary (par. 143). If points are satisfactory, check gap opening (par. 142).
- (e) If capacitor is faulty and a capacitor tester is available, test capacitor. Reading should be 25 to 26 mfd \pm 10 percent. Replace capacitor (par. 143) if reading is not within these limits. If capacitor tester is not available, check capacitor by substitution.

b. *No Spark (Ammeter Shows Normal Reading When Ignition Switch Is Turned On)*. If ammeter shows normal discharge with ignition switch turned on, the primary circuit is functioning and the trouble is in the secondary circuit.

- (1) *Faulty distributor cap*. Remove distributor cap (par. 143) and inspect for cracks or carbonized paths indicating current leaks. Inspect all carbon tips in cap for signs of excessive wear. Replace cap if necessary (par. 143).
- (2) *Faulty rotor*. Inspect rotor for signs of cracks or extreme wear. Replace rotor if necessary (par. 143).
- (3) *Faulty spark plug cables*. Inspect spark plug cables for cracks, breaks, or corrosion. Replace cables if necessary (par. 145).

c. *Weak Spark*.

- (1) *Loose electrical connections*. Clean and tighten all connections from starter to distributor and ignition coil assembly.
- (2) *Faulty ignition coil*. Check coil by substitution. Obtain a coil which is known to be operative. Remove coil and install test coil (par. 144). If spark is now satisfactory, old coil was faulty.
- (3) *Faulty distributor cap*. Refer to b(1) above.
- (4) *Faulty capacitor*. Refer to a(5) (e) above.
- (5) *Faulty breaker points*. Refer to a(5) (d) above.

d. *Engine Backfire*. Refer to paragraph 78c, e, and g.

e. *Engine Misfires At High Speed*. Refer to paragraph 78h.

82. Starting System

a. *Starter Fails To Operate*.

- (1) *Weak or discharged batteries*. Test batteries and charge or replace if necessary (par. 155).
- (2) *Loose battery ground cables*. Clean cable terminals and tighten bolts (par. 155).

- (3) *Faulty starter switch.* Check starter switch circuit with suitable test equipment or replace old switch (par. 149) with one known to be operating. If starter now operates, old starter switch was at fault.
- (4) *Faulty starter.* If the above operations have been completed and the starter still fails to operate, the starter is faulty and must be replaced (par. 148).

b. Noisy Starter Operation.

- (1) *Loose starter mounting.* Tighten all attaching parts.
- (2) *Lack of lubrication.* Lubricate starter (par. 66). If starter is still noisy, replace (par. 148).
- (3) *Worn starter.* Replace starter (par. 148).

c. Slow Cranking Speed.

- (1) *Weak or discharged batteries.* Refer to a(1) above.
- (2) *Loose battery ground cable.* Clean and tighten ground cable.
- (3) *Incorrect oil viscosity.* Inspect engine oil. Check records of oil changes and if found to be improper grade, drain and refill with correct grade of engine oil (par. 66).
- (4) *Worn starter.* Replace starter (par. 148).

83. Generating System

a. Battery Not Being Charged.

- (1) *General.* Before performing any generator system tests, check battery for discharge (par. 155). Some of the common conditions under which batteries become discharged are: the battery is worn out and will not hold a charge; more current has been used than supplied by the generator; battery solution has been allowed to become low; accidental discharge of the battery due to light, accessories, or ignition switch left on when generator was not charging; engine oil too heavy for the prevailing temperatures. Many of the so-called generating system failures may be attributed to the conditions mentioned above.
- (2) *Loose or corroded battery terminals.* Clean cable terminals and tighten bolts (par. 155).
- (3) *Faulty generator regulator.* If there is low or no charging rate with low battery, replace regulator (par. 153).
- (4) *Faulty ammeter.* Check ammeter circuit with suitable test equipment or replace old ammeter (par. 174) with one known to be operating. If, with engine running, ammeter now registers a charging rate, old ammeter was faulty.

(5) *Loose generator drive belts.* Adjust generator drive belts (par. 123).

(6) *Faulty generator.* If the generating system still fails to operate properly, replace the generator (par. 152).

b. High Charging Rate With Fully Charged Batteries. Replace generator regulator (par. 153).

c. Noisy Generator.

(1) *Lack of lubrication.* Lubricate generator (par. 66).

(2) *Loose generator mounting.* Tighten generator mounting bolts (par. 152).

(3) *Excessively tight drive belts.* Adjust drive belts (par. 123).

(4) *Faulty generator.* Replace generator (par. 152).

84. Battery and Lighting System

a. General. When checking or troubleshooting the battery lighting system, refer to the vehicle wiring diagram (fig. 80).

b. Discharged Batteries. Refer to paragraphs 83a and 155.

c. Vehicle Lights Do Not Illuminate.

(1) *Weak or discharged batteries.* Test battery specific gravity and charge or replace batteries if necessary (par. 155).

(2) *Faulty light switch.* Test light switch by substitution. Remove light switch (par. 182) and install a switch which is known to be serviceable. If lights now operate, old switch was faulty.

(3) *Faulty main feed cable.* Notify ordnance maintenance personnel.

(4) *Faulty generator regulator.* Replace generator regulator (par. 153).

(5) *Shorted or grounded cable in lighting system circuit causing circuit breaker to operate continually.* Inspect all cables in lighting circuit (fig. 80) and repair, replace, or notify ordnance maintenance personnel.

(6) *Corroded lamp contacts or broken lamp filament.* Clean corroded lamp contacts. Replace all lamps or lamp units which are broken or damaged (pars. 157-160 and 180).

d. One Light Fails To Illuminate.

(1) *Poor ground connection.* Inspect ground connection and tighten or repair if necessary.

(2) *Burned out lamp unit or lamp.* Replace burned out lamp unit or lamp (pars. 157-160 and 180).

(3) *Grounded or shorted feed cable between light switch and light.* Inspect cable for grounded or shorted condition, frayed insulation, loose terminal, or broken cable. Repair, replace, or tighten cable.

- (4) *Faulty light switch.* Replace light switch (par. 182).
- e. *Insufficient Light.*
- (1) *Dirty light lens.* Clean light lens.
 - (2) *Weak or discharged batteries.* Test batteries and charge or replace batteries if necessary (par. 155).
 - (3) *Faulty ground connection.* Inspect ground cable or connection and repair or tighten ground cable if necessary (par. 163).
 - (4) *Loose or corroded terminals.* Clean and tighten terminals (par. 163).
- f. *Frequent Light Failure.*
- (1) *Faulty generator regulator.* Replace generator regulator (par. 153).
 - (2) *High resistance in cable.* Inspect cable for frayed insulation, loose terminals, or breaks. Repair, tighten, or replace cables if necessary.
- g. *Stop Light Fails To Operate.*
- (1) *Burned out lamp.* Replace stop light lamp (par. 160).
 - (2) *Faulty light switch.* Replace light switch (par. 182).
 - (3) *Faulty stop light switch.* Test stop light switch by substitution. Remove switch (par. 186) and install one which is known to be operative. If stop light now operates, old switch was faulty.
 - (4) *Grounded or broken cables.* Inspect stop light circuit for grounded or broken cables. Repair or replace cables if necessary (par. 163).
 - (5) *Loose or corroded terminals.* Clean and tighten terminals (par. 163).

85. Cooling System

a. *Engine Overheats.*

- (1) *External leaks.* Fill cooling system and idle engine. Inspect radiator hose and connections for signs of leaks. Tighten hose connections or replace hose (par. 125) if necessary. Check area around water pump for damp spots or rust stains. Tighten water pump or replace (par. 124) if necessary. Inspect area around cylinder head for dampness or rust stains. Tighten cylinder head or replace cylinder-head gasket (par. 103). Inspect radiator core for dampness or rust spots and if leakage is found, replace radiator (par. 122). Inspect area around thermostat housing for evidence of leakage. Tighten thermostat housing or replace thermostat housing gasket (par. 126).
- (2) *Loose drive belt.* Adjust drive belt (par. 123).

- (3) *Faulty exhaust system.* Inspect exhaust pipe, exhaust pipe extension, and muffler for signs of dents, kinks, collapse, or restrictions of any kind. Replace any faulty parts (pars. 138 and 139).
- (4) *Fouled radiator core.* If air flow through radiator core is restricted due to insects, leaves, grease, dirt, etc., clean fins and air passages by blowing them out with compressed air.
- (5) *Incorrect ignition timing.* Time ignition (par. 142).
- (6) *Lean fuel mixture.* Adjust carburetor (par. 129).
- (7) *Worn radiator hose.* Inspect radiator hose and replace any hose that has become soft or collapsed (par. 125).
- (8) *Faulty thermostat.* Replace thermostat (par. 126).
- (9) *Clogged radiator.* Flush radiator as directed in TM 9-2858.
- (10) *Internal leaks.* Drain crankcase oil into a suitable container and observe if there is water in the oil. (Water being heavier than oil, will go to the bottom of the container. In moderate quantities, it will look like an air bubble at the bottom of the oil.) If water is found in the oil, remove the spark plugs (par. 145) and observe if water is present at the plug holes. Install spark plugs (par. 145) and refill crankcase with correct grade of engine oil (par. 66). With engine cold, fill radiator. Remove drive belts (par. 123) so that water pump is inoperative. Start engine and run at a fast idle for 60 seconds. If water runs out radiator filler pipe or overflow tube, or if bubbles come to the surface of the water in the radiator, leakage exists between one or more of the cylinders and the cooling system. If leakage is evident from any of these inspections, check cylinder-head nuts, using a torque wrench. If the nuts do not show evidence of looseness, remove the cylinder head (par. 103) and inspect for a faulty gasket. Examine cylinder block and head for cracks, paying particular attention to the area around the valve ports. Replace cylinder-head gasket (par. 103), or in the case of a cracked head or cylinder block, notify ordnance maintenance personnel.

b. Engine Fails To Reach Normal Operating Temperature. Start engine and allow to idle until temperature is at least normal (this can be determined by placing the hand on the radiator). If the gage still reads cold, the gage or sending unit is faulty. Test the gage and sending unit by substitution. Remove the water temperature gage (par. 176) and install one known to be operative.

If gage now registers, the old gage was faulty. If gage still does not register, remove sending unit (par. 187) and install one known to be operative. If gage now registers, sending unit was faulty.

86. Horn and Horn Button

a. Horn Does Not Sound.

- (1) *Horn disconnected.* Refer to vehicle wiring diagram (fig. 80) for wiring arrangement, and connect all cables.
- (2) *Faulty ground connection.* Remove horn (par. 185a) and clean contacting surfaces. Install horn (par. 185b).
- (3) *Broken main feed cable.* Disconnect main feed cable at horn switch and ground it momentarily. Note whether a spark occurs when cable is grounded. If no spark occurs, there is an open circuit between the main feed cable and the battery. Inspect main feed wire and make necessary repairs.
- (4) *Faulty switch.* Disconnect main feed cable at switch and touch end of main feed cable to horn terminal of switch. If horn now sounds, switch is faulty. Replace horn switch (par. 184).
- (5) *Faulty horn.* If, after the above steps have been performed, horn does not sound, horn is faulty and must be replaced (par. 185).

b. Horn Sounds Continually.

- (1) *Horn button or horn switch push rod jammed.* Remove and check horn button and horn switch push rod (par. 184).
- (2) *Short circuit in horn switch assembly.* Replace horn switch assembly (par. 184b).

87. Instruments, Gages, Switches, and Sending Units

a. Ammeter.

- (1) *Fails to register.* Turn off all lights and electrical accessories, start engine and run it at a speed equivalent to a vehicle speed of 20 mph. If ammeter pointer fails to move to charge side of gage for at least the time required to restore the current used in starting, either the generating system (par. 83) or ammeter is at fault. Stop engine and turn on headlights. Ammeter pointer should move to discharge side of gage. If pointer does not indicate on either side of gage, replace ammeter (par. 174).
- (2) *Reads incorrectly.* Connect an ammeter which is known to be operative in series with ammeter on vehicle. Start

engine and observe ammeter pointer location on each ammeter. If pointer location varies between the two ammeters, replace ammeter (par. 174).

- (3) *Reads backward.* Incorrect cable connections. Refer to instruments, gages, switches, and sending units identification diagram (fig. 83) and paragraph 163 for correct cable connecting points.

b. *Fuel Gage Fails To Register.*

- (1) *Faulty wiring.* Refer to instruments, gages, switches, and sending units identification diagram (fig. 85) and paragraph 163 for location of cables. Inspect cables for frayed insulation, loose connections, cracks, or breaks. Tighten connections or repair cables if necessary.
- (2) *Faulty fuel tank level sending unit.* Test sending unit by substitution. Obtain a sending unit which is known to be operative. Remove sending unit (par. 189) from fuel tank and install sending unit to be used for test. If, with ignition switch on, fuel gage now operates, old sending unit was at fault.
- (3) *Faulty fuel gage.* Test fuel gage by substitution. Obtain a fuel gage which is known to be operative. Remove fuel gage (par. 175) from vehicle and install test fuel gage. If, with ignition switch on, fuel gage now registers, old fuel gage was faulty.

c. *Water Temperature Gage Fails To Register.*

- (1) *Faulty wiring.* Refer to instruments, gages, switches, and sending units identification diagram (fig. 85) and paragraph 163 for location of cables. Inspect cables for frayed insulation, loose connection, cracks, or breaks. Tighten or repair cables if necessary.
- (2) *Faulty water temperature sending unit.* Test sending unit by substitution. Obtain a sending unit which is known to be operative. Remove sending unit (par. 187) from vehicle and install sending unit to be used for test. If, with ignition switch on, temperature gage now registers, old gage was faulty.
- (3) *Faulty water temperature gage.* Test gage by substitution. Obtain a gage which is known to be operative. Remove gage (par. 176) and install gage to be used for test. If, with ignition switch on, temperature gage now registers, old gage was faulty.

d. *Oil Pressure Gage Fails To Register.*

- (1) *Faulty wiring.* Refer to instruments, gages, switches and sending units identification diagram (fig. 85) and para-

graph 163 for location of cables. Inspect cables for frayed insulation, cracks, breaks, or loose connections. Repair cables if necessary.

- (2) *Faulty oil pressure sending unit.* Test sending unit by substitution. Obtain a sending unit which is known to be operative. Remove sending unit (par. 188) from vehicle and install sending unit to be used for test. If, with engine running, pressure gage now registers, old sending unit was faulty.
- (3) *Faulty oil pressure gage.* Test gage by substitution. Obtain a gage which is known to be operative. Remove gage (par. 177) and install gage which is to be used for test. If, with engine running, gage now registers, old gage was faulty.

e. Speedometer.

- (1) *Speedometer fails to show either speed or mileage or pointer fluctuates.*
 - (a) *Kinked or broken flexible shaft assembly or core.* Refer to ordnance maintenance personnel.
 - (b) *Binding in speedometer.* Disconnect flexible shaft at speedometer. Obtain a short piece of flexible shaft core about 2 or 3 inches long with a tip to fit the speedometer socket. Insert the piece of core into speedometer socket and spin core between the thumb and forefinger in the proper direction to cause speedometer pointer to indicate speed on speedometer dial. If there is a tendency for the speedometer to bind, replace speedometer (par. 178).
- (2) *Speedometer fails to show either speed or mileage or pointer will not return to zero.* Faulty speedometer. Replace speedometer (par. 178).

f. Headlight High Beam Indicator Light.

- (1) *Fails to light.*
 - (a) *Lamp burned out.* Replace lamp (par. 179).
 - (b) *Faulty wiring.* Refer to paragraph 163 for correct cable and connection. Inspect cable for frayed insulation, cracks, breaks, or loose connections. Tighten connections or repair if necessary.
- (2) *Lamp flickers.* Loose cable connections or lamp loose in socket. Tighten lamp and cable connections.

g. Headlight Dimmer Switch.

- (1) *Fails to operate.*
 - (a) *Loose cable connections or faulty wiring.* Refer to paragraph 163 for correct cables and connections. Inspect cables for frayed insulation, cracks, or breaks.

Inspect cable connections for tightness. Tighten connections or repair cables if necessary.

(b) *Faulty switch.* Test switch by substitution. Obtain a switch which is known to be operative. Remove switch (par. 183) and install switch which is to be used for test. If, with headlights on, switch now operates, old switch was faulty.

(2) *Switch can be depressed but will not return.* Dirty or faulty switch. Remove switch (par. 183) and clean with volatile mineral spirits. If cleaning does not correct the trouble, replace the switch (par. 183).

h. Instrument Panel Lights.

(1) *One lamp fails to light.*

(a) *Burned out lamp.* Replace defective lamp (par. 180).

(b) *Loose or faulty cable.* Inspect cable connections at instrument panel light and at light switch for evidence of loose or faulty cable. Tighten terminal connections or replace defective cable.

(c) *Faulty instrument panel light.* If the above conditions were checked and lamp still does not burn, the light is faulty and must be replaced (par. 180).

(2) *Both instrument panel lamps fail to light.*

(a) *Burned out lamps.* Replace defective lamps (par. 180).

(b) *Loose or faulty cable.* Refer to (1) (b) above.

(c) *Faulty instrument panel light.* Refer to (1) (c) above.

(d) *Faulty light switch.* If the above conditions were checked and instrument panel lamps still do not operate, it indicates a faulty switch which must be replaced (par. 182).

i. Ignition Switch Fails To Operate.

(1) *Loose or faulty wiring.* Inspect cables for loose connections, frayed insulation, cracks, or breaks. Tighten connections or repair cables if necessary.

(2) *Faulty switch.* Replace ignition switch (par. 181).

88. Radio Interference Suppression System

a. Locate Source of Noise. To locate source of radio interferences emanating from the vehicle, the use of a radio receiver in the vehicle or adjacent vehicle will be necessary. Determining the type of interference present in the receiver will help to determine the cause of the trouble. To determine if the noise is coming from the vehicle or from an outside source, drive the vehicle at least 100 feet from any other vehicle. Turn the ignition switch off and turn the radio on. Any noise heard in the radio will be coming from an

outside source. Start the engine and any other noise heard in the radio will be coming from the vehicle itself.

b. Engine.

- (1) Start the engine and run it at an idle speed and listen for noises in the radio receiver. If a crackling or clicking sound is present, accelerate engine and turn ignition switch off. If the noise stops immediately, the trouble is in the ignition circuit (*c* below). If an irregular clicking or chattering sound continues for a few seconds after the ignition switch is turned off, the trouble is being caused by the generating circuit (*d* below). If the interference is in the form of a whining or whirring sound which varies with the engine speed, turn ignition switch off. If the tone of the sound lowers in pitch but continues for a few seconds after the switch is turned off, it is caused by the generator (*e* below).
- (2) Start the engine and put the vehicle in motion and note if there is any interference present in the receiver. If a clicking or scratching noise is present, stop vehicle but leave engine running. If the noise stops when the motion of the vehicle stops, the trouble is caused by loose connections or frayed cable insulation in vehicle wiring (*f* below).

c. Ignition Circuit. Make sure the ignition system is functioning properly (par. 81). Incorrect spark plug gaps, distributor breaker point adjustment, or worn parts will affect the suppression system. Clean and tighten all electrical connections and engine mountings. Disconnect cable from one spark plug and start engine, note if interference is reduced or eliminated by this action. Test the remaining three spark plug cables. If removal of any one or more cables eliminates the interference, the trouble is in the spark plug resistor or the ignition filter. Replace the spark plug (par. 145) or the ignition filter (par. 143e).

d. Generating Circuit. Check generator regulator mounting bolts and tighten if necessary. Check wiring harness connecting the generator to the generator regulator for broken or damaged insulation. Replace generator (par. 152) or generator regulator (par. 153) if necessary.

e. Generator. Check generator mounting bolts and tighten if necessary. If noise still persists, replace generator (par. 152).

f. Wiring. Inspect all wiring cables for worn, frayed, or otherwise damaged insulation. Replace cables if faulty. Clean and tighten all connections.

89. Clutch

a. Clutch Drags.

- (1) *Excessive clutch pedal clearance.* Start engine and run it at an idle. Depress clutch pedal to full released position, and allow clutch time to stop rotating. Shift transmission into first or reverse gear. If the shift cannot be made without clashing of gears or after engagement of gears, there is a jumping or creeping movement of the vehicle with clutch pedal fully depressed, the clutch is dragging. Adjust clutch pedal free travel (par. 196).
- (2) *Warped or cracked driven disk assembly.* Refer to ordnance maintenance personnel.

b. Clutch Slips.

- (1) *Insufficient clutch pedal free travel.* Adjust pedal free travel (par. 196).
- (2) *Worn driven disk assembly.* Refer to ordnance maintenance personnel.
- (3) *Grease or oil on driven disk facing.* Refer to ordnance maintenance personnel. Slippage and failures may be caused by engine and transmission lubricants that become trapped in the flywheel housing and cover the clutch components. To eliminate this source of trouble, remove flywheel housing drain plug and store in map (glove) compartment. Be sure to install plug before undergoing fording operations.
- (4) *Worn out clutch.* Refer to ordnance maintenance personnel.

c. Clutch Chatters.

- (1) *Incorrect pedal free travel.* Adjust pedal free travel (par. 196).
- (2) *Oil or grease on driven disk facing.* Refer to ordnance maintenance personnel.
- (3) *Incorrect connections.* Inspect transmission mountings, propeller shafts, universal joints, and engine mountings for loose connections. Tighten all connections.

d. Clutch Squeals When Released.

- (1) *Oil or grease on pressure plate.* Refer to ordnance maintenance personnel.
- (2) *Worn release bearing.* Notify ordnance maintenance personnel.
- (3) *Dry clutch shaft or flywheel bearing.* Refer to ordnance maintenance personnel.

e. *Clutch Pedal Pressure Exceedingly Stiff.*

- (1) *Insufficient lubrication of linkage.* Lubricate linkage (par. 66).
- (2) *Bent or damaged parts in linkage.* Refer to ordnance maintenance personnel.
- (3) *Faulty clutch.* Refer to ordnance maintenance personnel.

90. Transmission

a. *Transmission Will Not Shift Into Any Gear.*

- (1) *Improper clutch pedal adjustment.* Adjust clutch pedal free travel (par. 196).
- (2) *Incorrect lubricant.* If this condition occurs in extreme cold weather, transmission lubricant may be of incorrect viscosity. Check records of lubricant changes and if found to be improper grade, drain and refill with correct lubricant (par. 66).
- (3) *Faulty clutch.* Refer to ordnance maintenance personnel.
- (4) *Worn or damaged transmission.* Replace (pars. 206 and 207) or refer to ordnance maintenance personnel.

b. *Excessive Noise.*

- (1) *Lack of lubricant.* Check transmission lubricant level and refill if necessary (par. 66).
- (2) *Worn or damaged transmission.* Replace (pars. 206 and 207) or refer to ordnance maintenance personnel.
- (3) *Worn or damaged transfer.* Noises originating in the vicinity of the transmission are sometimes due to a faulty transfer. Place transmission shift lever in N (neutral) position and start engine. If noise is now excessive, trouble is in transmission. If noise is excessive only when transfer is engaged, trouble lies in transfer. Replace either transmission (pars. 206 and 207) or transfer (pars. 200 and 201), or notify ordnance maintenance personnel.

c. *Hard Shifting.*

- (1) *Clutch fails to release.* Adjust pedal free travel (par. 196).
- (2) *Incorrect lubricant.* Refer to paragraph 66 for lubrication instructions.
- (3) *Worn or damaged transmission.* Replace (pars. 206 and 207) or refer to ordnance maintenance personnel.

d. *Transmission Slips Out Of Gear.*

- (1) *Bent shifting fork.* Refer to ordnance maintenance personnel.

- (2) *Worn or broken shift poppet springs.* Replace transmission (pars. 206 and 207) or refer to ordnance maintenance personnel.
 - (3) *Excessively worn transmission gears.* Replace transmission (pars. 206 and 207) or notify ordnance maintenance personnel.
 - (4) *Excessive end play in either transmission main shaft or countershaft.* Replace transmission (pars. 206 and 207) or notify ordnance maintenance personnel.
- e. *Transmission Leaks Lubricant.*
- (1) *Loose or damaged drain plug.* Tighten or replace drain plug.
 - (2) *Loose mounting connections.* Tighten mounting connections.
 - (3) *Damaged or defective oil seals or gaskets.* Notify ordnance maintenance personnel.

91. Transfer

- a. *Transfer Shift Levers Fail To Shift into Gear or Shift Hard.*
- (1) *Insufficient lubrication or improper grade of lubricant.* Check lubricant level. Drain and fill transfer with proper grade of lubricant (par. 66).
 - (2) *Transfer improperly alined with transmission.* Remove transfer (par. 200), aline, and install (par. 201).
 - (3) *Worn or damaged parts.* Replace transfer (pars. 200 and 201) or notify ordnance maintenance personnel.
- b. *Excessive Noise.*
- (1) *Lack of lubrication.* Check lubricant level. Drain and refill transfer with proper grade of lubricant (par. 66).
 - (2) *Worn or damaged parts.* Replace transfer (pars. 200 and 201) or notify ordnance maintenance personnel.
 - (3) *Transfer not properly alined with transmission.* Remove transfer (par. 200), aline, and install (par. 201).
 - (4) *Loose or damaged propeller shafts.* Replace either front or rear propeller shafts (pars. 209 and 210) if necessary.
 - (5) *Insufficient clearance between the transfer high range shift lever and the floor board* (par. 119).
- c. *Transfer Slips Out of Gear.*
- (1) *Bent shifting forks.* Refer to ordnance maintenance personnel.
 - (2) *Weak or broken shift coil poppet springs.* Replace transfer (pars. 200 and 201) or refer to ordnance maintenance personnel.

- (3) *Worn or damaged gears on shafts.* Replace transfer (pars. 200 and 201) or refer to ordnance maintenance personnel.

d. Transfer Leaks Lubricant.

- (1) *Loose or damaged drain plug.* Tighten or replace drain plug.
- (2) *Loose attaching parts.* Tighten attaching parts.
- (3) *Damaged gaskets or oil seals.* Replace transfer (pars. 200 and 201) or notify ordnance maintenance personnel.

92. Propeller Shafts and Universal Joints

a. Propeller Shaft Backlash.

- (1) *Worn or damaged universal joint bearings, yokes, or trunnions.* Replace universal joints or propeller shafts (pars. 209 and 210) if excessive backlash is noted.
- (2) *Loose bolts at propeller shaft companion flanges or loose U-bolts.* Tighten companion flange bolts and U-bolts.

b. Excessive Noise or Vibration.

- (1) *Worn or damaged universal joints.* Replace universal joints (pars. 209 and 210).
- (2) *Bent or distorted propeller shaft.* Replace propeller shaft (pars. 209 and 210).
- (3) *Insufficient lubrication.* Lubricate universal joints and propeller shafts (par. 66).
- (4) *Loose companion flange bolts or U-bolts.* Tighten companion flange bolts and U-bolts.
- (5) *Stripped splines on universal joint sleeve yokes.* Replace propeller shaft and universal joint sleeve yokes (pars. 209 and 211) if necessary.

93. Front Axle

a. Hard Steering.

- (1) *Insufficient lubrication.* Lubricate as prescribed in paragraph 66.
- (2) *Tight steering gear.* Adjust steering gear (par. 234).
- (3) *Bind in steering knuckle.* Refer to ordnance maintenance personnel.
- (4) *Incorrect toe-in.* Check and adjust toe-in (par. 234).
- (5) *Underinflated tires.* Inflate tires to correct pressure (par. 254).
- (6) *Excessive caster.* Notify ordnance maintenance personnel.

b. Front End Shimmys. Refer to paragraph 99f.

c. Vehicle Wanders.

- (1) *One tire underinflated.* Inflate tire to correct pressure (par. 254).
- (2) *Loose or improperly adjusted front hub bearings.* Adjust or replace hub bearings (par. 225).
- (3) *Incorrect steering gear adjustment.* Adjust steering gear (par. 219).
- (4) *Loose or worn tie rods or drag link.* Adjust or replace tie rods (pars. 234 and 235) or drag link (par. 237).
- (5) *Loose or worn parts in front axle.* Replace front axle assembly (par. 234).
- (6) *Incorrect steering alignment due to accident.* Notify ordnance maintenance personnel.
- (7) *Wheel rubs fender or frame on extreme turn.* Notify ordnance maintenance personnel.

d. Excessive Noise On Front Axle.

- (1) *Vibration due to loose and worn front propeller shaft.* Replace propeller shaft (pars. 209 and 210).
- (2) *Insufficient lubrication.* Lubricate as prescribed in paragraph 66.
- (3) *Worn front axle differential gears.* Replace front axle assembly (par. 231).
- (4) *Worn front axle shafts.* Replace front axle shafts or front axle assembly as necessary (pars. 224 and 231).
- (5) *Worn or improperly adjusted front hub bearings.* Adjust or replace hub bearings (par. 225).

e. Leaks Lubricant.

- (1) *Loose or damaged drain plug.* Tighten or replace drain plug.
- (2) *Faulty steering knuckle flange oil seals.* Replace oil seals (par. 229).
- (3) *Cracked axle housing.* Replace front axle assembly (par. 231).

94. Rear Axle

a. Continuous Rear Axle Noise.

- (1) *Insufficient lubrication.* Lubricate as prescribed in paragraph 66.
- (2) *Tires improperly inflated or unequally worn.* Inflate tires to correct pressure (par. 254) or replace worn tires (TM 21-300).
- (3) *Rear axle shaft bearings worn, improperly adjusted, or inadequately lubricated.* Repack, adjust, or replace rear axle shaft bearings (par. 216).

- (4) *Worn or improperly adjusted rear axle differential gears and bearings.* Replace rear axle assembly (par. 220).
- (5) *Loose or damaged rear propeller shaft.* Replace propeller shaft (pars. 209 and 210).

b. Rear Axle Noise in Drive Only or Coast Only.

- (1) *Rear axle shaft bearings worn, improperly adjusted, or inadequately lubricated.* Refer to a(3) above.
- (2) *Drive pinion and drive gear worn or out of adjustment.* Replace rear axle assembly (par. 220).

c. Excessive Backlash in Axle Driving Parts.

- (1) *Loose axle flange attaching parts.* Tighten all attaching parts.
- (2) *Drive pinion and drive gear worn or out of adjustment.* Replace rear axle assembly (par. 220).

d. Leaks Lubricant.

- (1) *Loose or damaged drain plug.* Tighten or replace drain plug.
- (2) *Faulty inner oil seals.* Replace oil seals (par. 215 a(1)-(9) and c).
- (3) *Cracked axle housing.* Replace rear axle assembly (par. 220).

95. Service Brakes

a. Brakes Lock During Operation.

- (1) *Restricted bypass port in master cylinder.* Replace master cylinder (par. 244).
- (2) *Improperly adjusted brakes.* Adjust brakes (par. 242).
- (3) *Dirt in brake fluid.* Disconnect brake line at master cylinder and lines at wheel cylinders. Clean brake lines by blowing out with compressed air. Remove master cylinder (par. 244) and clean with brake fluid. Install master cylinder (par. 244), connect lines at wheel cylinders and master cylinder. Refill brake system with fluid and bleed brakes (par. 246).

Note. If brakes are locked preventing movement of the vehicle, momentarily open bleeder valve (fig. 115) at any wheel cylinder. A few drops of brake fluid will come out; thus pressure will be relieved and the brakes freed. This is a temporary measure and does not correct the cause of the trouble.

b. Brakes Do Not Apply.

- (1) *Incorrect brake adjustment.* Adjust brakes (par. 242).
- (2) *Loose connections or faulty lines.* Inspect all lines and connections for signs of leakage. Tighten or replace faulty lines or connections (par. 245).

- (3) *Faulty master cylinder.* Replace master cylinder (par. 244).
- (4) *Faulty wheel cylinder.* Inspect wheel cylinders for evidence of leaks. Replace any faulty wheel cylinder (par. 243).
- (5) *Air in brake system.* Bleed brake system (par. 246).

c. Low Pedal Reserve.

- (1) *Improper adjustment.* Adjust brakes (par. 242).
- (2) *Worn brake linings.* Replace brake shoes (par. 242).

d. Noisy Brakes.

- (1) *Dirty or worn brake linings.* Replace brake shoes (par. 242).
- (2) *Loose lining rivets or sprung brake shoes.* Replace brake shoes (par. 242).
- (3) *Distorted brake drums.* Replace brake drums (par. 242).
- (4) *Broken shoe retracting springs.* Replace retracting springs (par. 242).

e. Hard Brake Action.

- (1) *Normal brake lining wear.* Adjust brakes (par. 242).
- (2) *Glazed linings.* Replace brake shoes (par. 242).

96. Handbrake

a. Brake Fails To Apply.

- (1) *Improper adjustment.* Adjust brake (par. 247).
- (2) *Worn linings.* Replace brake shoes (par. 247).
- (3) *Broken or stretched cable.* Notify ordnance maintenance personnel.

b. Brake Fails To Hold Parked Vehicle.

- (1) *Improper adjustment.* Adjust brake (par. 247).
- (2) *Worn linings.* Replace brake shoes (par. 247).
- (3) *Oil or grease on linings.* Replace brake shoes (par. 247).

c. Brake Drags and Overheats.

- (1) *Brake not completely released when vehicle is in motion.* Be sure brake is completely released before putting vehicle in motion.
- (2) *Incorrect adjustment.* Adjust brake (par. 247).
- (3) *Brake drum out-of-round.* Replace brake drum (par. 247).

97. Wheels and Tires

a. Excessive or Uneven Tire Wear.

- (1) *Incorrect tire pressure.* Inflate tires to correct pressure (par. 254).

- (2) *Improper front wheel alinement.* Check front wheel alinement and correct if necessary (par. 234).
- (3) *Bent wheel.* Replace any bent or distorted wheels (par. 256).
- (4) *Damaged or improperly adjusted front hub bearings.* Inspect hub bearings and adjust or replace if necessary (par. 225).
- (5) *Wheel stud nuts loose.* Tighten stud nuts (par. 256).
- (6) *Wheel out of balance.* Remove (par. 256) and remount tire in a different position. If trouble is not corrected, replace wheel (par. 256) or tire (par. 257).

b. Wheel Wobbles.

- (1) *Bent wheel.* Replace any bent or damaged wheels (par. 256).
- (2) *Damaged or improperly adjusted front hub bearings.* Adjust or replace hub bearings (par. 225).
- (3) *Wheel loose on hub.* Tighten stud nuts (par. 256).
- (4) *Wheel out of balance.* Remove (par. 256) and remount tire in different position. If trouble is not corrected, replace wheel (par. 256) or tire (TM 21-300).

c. Wheel Pounds.

- (1) *Damaged or improperly adjusted front hub bearings.* Adjust or replace hub bearings (par. 225).
- (2) *Bent wheel.* Replace any bent or damaged wheels (par. 256).
- (3) *Damaged tire.* Inspect tire for breaks or bulges, replace tire (TM 21-300), if necessary.

98. Springs and Shock Absorbers

a. Insufficient Flexibility.

- (1) *Lack of lubrication.* Lubricate in accordance with paragraph 66.
- (2) *Frozen spring shackles.* Free shackle and lubricate (par. 66).
- (3) *Faulty shock absorbers.* Disconnect shock absorbers (par. 253) and test action by compressing lower section into upper section. If little or no effort is necessary to compress shock absorbers, replace (par. 253).

b. Excessive Flexibility.

- (1) *Over lubrication.* Clean excess lubricant from springs and lubricate in accordance with paragraph 66.
- (2) *Faulty shock absorbers.* Refer to *a*(3) above.
- (3) *Broken spring leaves.* Inspect springs for evidence of broken leaves. Replace springs (par. 252) if necessary.

c. Vehicle Sags to One Side.

- (1) *Improper load distribution.* Check load for correct weight distribution and relocate load if necessary.
- (2) *Weak springs.* Inspect springs for extreme sag, replace any weak springs (par. 252).
- (3) *Broken spring leaf.* Inspect springs for broken leaves and replace (par. 252) if necessary.
- (4) *Underinflated tires.* Inflate tires to correct pressure (par. 254).

d. Excessive Spring Noise.

- (1) *Inadequate lubrication.* Lubricate in accordance with paragraph 66.
- (2) *Worn spring pivot bolts or spring shackles.* Use a pry bar to test wear of shackles and pivot bolts. If excessive movement is noted, replace shackles (par. 250) or pivot bolts (par. 251).
- (3) *Worn or faulty shock absorbers.* Replace shock absorbers (par. 253).
- (4) *Loose or worn spring center bolt.* Replace spring (par. 252).

e. Repeated Spring Leaf Failure.

- (1) *Loose spring U-bolts.* Tighten spring U-bolts.
- (2) *Overloading or improper operation on rough terrain.* Refer to vehicle shipping data plate (fig. 4) for maximum load and reduce vehicle speed when driving over rough terrain.
- (3) *Spring leaf failure at spring eye.* Improperly adjusted spring shackles or frozen pivot bolts. Free and lubricate pivot bolts (par. 66) and adjust spring shackles (par. 250).
- (4) *Spring leaf failure at center section of spring.* Loose spring U-bolts. Tighten spring U-bolts.

99. Steering

a. Vehicle Wanders.

- (1) *Tight steering knuckle flange cap bearings.* Adjust bearings (par. 230c(5)).
- (2) *Improper tire pressure.* Inflate tires to correct pressure (par. 254).
- (3) *Steering gear bind.* Adjust steering gear (par. 239).
- (4) *Caster lower than standard.* Notify ordnance maintenance personnel.
- (5) *Caster uneven.* Notify ordnance maintenance personnel.
- (6) *Incorrect toe-in.* Adjust toe-in (par. 234).

- (7) *Worn or damaged drag link.* Replace drag link (par. 237).
 - (8) *Worn or damaged tie rods.* Replace tie rods (par. 235).
 - (9) *Broken or weak spring.* Replace spring (par. 252).
 - (10) *Loose spring U-bolts.* Tighten U-bolts.
 - (11) *Loose steering gear mounting bolts.* Tighten mounting bolts.
 - (12) *Bent spindle or steering knuckle flange arm.* Notify ordnance maintenance personnel.
- b. *Vehicle Steers to One Side.*
- (1) *Uneven caster.* Notify ordnance maintenance personnel.
 - (2) *Low air pressure in one tire.* Inflate tire to correct pressure (par. 254).
 - (3) *Incorrect brake adjustment.* Adjust brakes (par. 242).
 - (4) *Worn or incorrectly adjusted front hub bearings.* Adjust or replace hub bearings (par. 225).
 - (5) *Broken or weak springs.* Replace any broken or weak springs (par. 252).
 - (6) *Bent rear axle housing.* Replace rear axle assembly (par. 220).
 - (7) *Bent vehicle frame.* Notify ordnance maintenance personnel.
 - (8) *Bent spindle or steering knuckle flange arm.* Notify ordnance maintenance personnel.
- c. *Shimmy at High Speed.*
- (1) *Wheel and/or tire out of balance.* Remount tire in different position (par. 255) or replace tire and wheel (par. 256 and TM 31-200).
 - (2) *Loose or worn shock absorbers.* Tighten shock absorber mountings or replace (par. 253) if necessary.
 - (3) *Worn drag link or tie rods.* Replace drag link or tie rods (pars. 235 and 237).
 - (4) *Loose steering gear mounting bolts.* Tighten mounting bolts.
 - (5) *Loose spring U-bolts.* Tighten U-bolts.
 - (6) *Broken or weak spring.* Replace faulty spring (par. 252).
 - (7) *Incorrect tire pressure.* Inflate tires to prescribed pressure (par. 254).
- d. *Road Sway.*
- (1) *Incorrect tire pressure.* Inflate tires to correct pressure (par. 254).
 - (2) *Tight steering knuckle flange cap bearings.* Adjust bearings (par. 230c(5)).

- (3) *Loose or worn shock absorbers.* Tighten shock absorber mounting nuts or replace shock absorbers (par. 253) if necessary.
- (4) *Steering gear bind.* Adjust steering gear (par. 239).
- (5) *Loose steering gear mounting bolts.* Tighten mounting bolts.
- (6) *Loose spring U-bolts.* Tighten U-bolts.
- (7) *Weak or broken spring.* Replace faulty spring (par. 252).

e. *Road Shock.*

- (1) *Steering gear off center.* Notify ordnance maintenance personnel.
- (2) *Incorrect drag link adjustment.* Adjust drag link (par. 237).
- (3) *Cupped tires.* Inspect tires and replace (TM 21-300) if necessary.
- (4) *Bent pitman arm.* Notify ordnance maintenance personnel.
- (5) *Bent spindle or steering knuckle flange arm.* Notify ordnance maintenance personnel.
- (6) *Worn steering gear.* Replace steering gear (par. 239).

f. *Shimmy at Low Speed.*

- (1) *Unequal tire pressure.* Inflate tires to correct pressure (par. 254).
- (2) *Loose or worn steering knuckle flange cap bearings.* Adjust bearings (par. 230c(5)).
- (3) *Worn drag link ends.* Replace drag link (par. 237).
- (4) *Loose steering gear mounting bolts.* Tighten mounting bolts.
- (5) *Loose spring U-bolts.* Tighten U-bolts.
- (6) *Broken or weak springs.* Replace faulty springs (par. 252).

g. *Loose Steering.*

- (1) *Loose or worn steering knuckle flange cap bearings.* Adjust bearings (par. 230c(3)).
- (2) *Worn drag link ends.* Replace drag link (TM 21-300).
- (3) *Worn tie rod ends.* Replace faulty tie rod ends (par. 235).
- (4) *Loose steering gear mounting bolts.* Tighten mounting bolts.
- (5) *Loose spring U-bolts.* Tighten U-bolts.

- (6) *Weak or broken spring.* Replace faulty spring (par. 252).
- (7) *Brake drum out-of-round.* Replace brake drum (par. 228).

h. Hard Steering.

- (1) *Lack of lubrication.* Lubricate as prescribed in paragraph 66.
- (2) *Low tire pressure.* Inflate tires to correct pressure (par. 254).
- (3) *Tight steering knuckle flange cap bearings.* Adjust bearings (par. 230c(5)).
- (4) *Steering gear bind.* Adjust steering gear (par 239).
- (5) *Incorrect caster angle.* Notify ordnance maintenance personnel.
- (6) *Interference between right wheel and right front fender, right side of chassis frame and right front chassis lifting hook.* See paragraph 239.

100. Windshield Wipers

a. Both Windshield Wipers Fail to Operate.

- (1) *Shutoff valve not completely turned on.* Be sure valve is completely turned on.
- (2) *Wiper blades stuck to windshield.* Free blades from windshield. Replace blades if damaged (par. 266).
- (3) *Loose vacuum line connection or faulty lines.* Inspect for loose connections or broken or cracked lines. Replace lines or connections if necessary.
- (4) *Plugged or kinked vacuum line from fuel and vacuum pump to windshield wiper motor.* Disconnect line at fuel and vacuum pump and at windshield wiper motor. Blow compressed air through line to clear it of any obstructions. If line cannot be cleared, replace.
- (5) *Sticking paddles in windshield wiper motors.* Move windshield wiper handle to loosen paddles. Disconnect hose at windshield wiper motor and insert a few drops of engine oil into motor. Work wiper handle to distribute the oil and connect vacuum line. Start engine and operate wipers. If trouble is not corrected, replace wiper motors (par. 265).

b. Right Windshield Wiper Motor Fails to Operate.

- (1) *Hose between right and left wiper motor loose or damaged.* Examine hose at connections and along entire length for nicks, cracks, or breaks. Tighten connections or replace hose or connections.
- (2) *Sticking paddle in wiper motor.* Refer to a(5) above.

Section V. ENGINE DESCRIPTION AND MAINTENANCE IN VEHICLE

101. Description and Data

a. Description. The engine is a conventional L-head, four-cylinder, four-cycle, liquid-cooled, gasoline-fueled unit. The engine, transmission, transfer, and radiator are mounted on a subframe which can be removed and installed as a single unit and which is termed the power plant (figs. 31 and 32). The electrical system is waterproofed. The power plant is sealed and vented for deep water and underwater fording operation. The oil filler pipe assembly is a steel tube projecting from the upper portion of the crankcase on the right side of the engine. The pipe has a sealed cap, at the top, which is removed to add engine oil. A bayonet-type oil level gage is fastened to the underside of the cap. The control valve hose, for deep water fording, is connected to the oil filler pipe near the top.

b. Data.

Manufacturer	Willys Motors Inc
Model	MC
Engine:	
Type	l-head
Number of cylinders	4
Bore and stroke	3½ x 4¾
Piston displacement	134.2 cu-in.
Brake horsepower at 4,000 rpm	60
Torque at 2,000 rpm	105 lb-ft
Compression at cranking speed	110 psi
Firing order	1-3-4-2
Valve clearance	0.016 in.
Weights:	
Power plant	663 lb
Engine, less accessories	351 lb
Engine, with accessories	483 lb
Crankcase oil capacity	5 qt
Drain plugs:	
Crankcase	Left side, front
Transmission	Left side, front
Transfer	Bottom, right front

102. Operations Performed With Engine in Vehicle

Following is a reference list of engine components and the paragraphs which cover removal, installation, or maintenance procedures with the engine in the vehicle.

	<i>Paragraph</i>
Air cleaner	132
Batteries and cables	155, 156
Carburetor	129
Carburetor controls	130
Clutch linkage adjustment	196
Cylinder-head gasket	103
Cylinder-head replacement	104
Deep-water fording vent metering and control valves ...	107
Drive belts (fan and generator)	123
External lines and fittings	113
Fuel and vacuum pump	131
Generator	152
Generator regulator	153
Ignition system	140-146
Intake and exhaust manifolds	108-109
Lines and fittings	113, 135
Oil filler pipe	112
Oil filter	110
Oil filter cartridge	111
Radiator	122
Radiator hose	125
Starter and starter switch	148, 149
Thermostat	126
Valve tappet clearance adjustment	105
Valve tappet compartment cover and gasket	106
Water pump, fan, and fan and water pump pulley	124

103. Cylinder Head Gasket

Note. The key letters noted in parentheses are in figure 24, except where otherwise indicated.

a. Removal.

- (1) Drain the cooling system (par. 121).
- (2) Loosen hose clamp screws at both ends of the water inlet hose (P, fig. 23) and remove the hose. Loosen hose clamp screws at each end of the bypass hose (L, fig. 23) and remove the hose.
- (3) Remove the vent line (C, fig. 23) between the carburetor assembly (J, fig. 23) and the air intake pipe with vent valve and bracket assembly (B, fig. 23) by unscrewing the nut at each end of the line. Remove the vent line (Q), between the distributor with coil assembly (M) and the air intake pipe, by unscrewing the nut at each end of the line. Remove the vacuum hose (F, fig. 23), between the distributor and the tee (H,

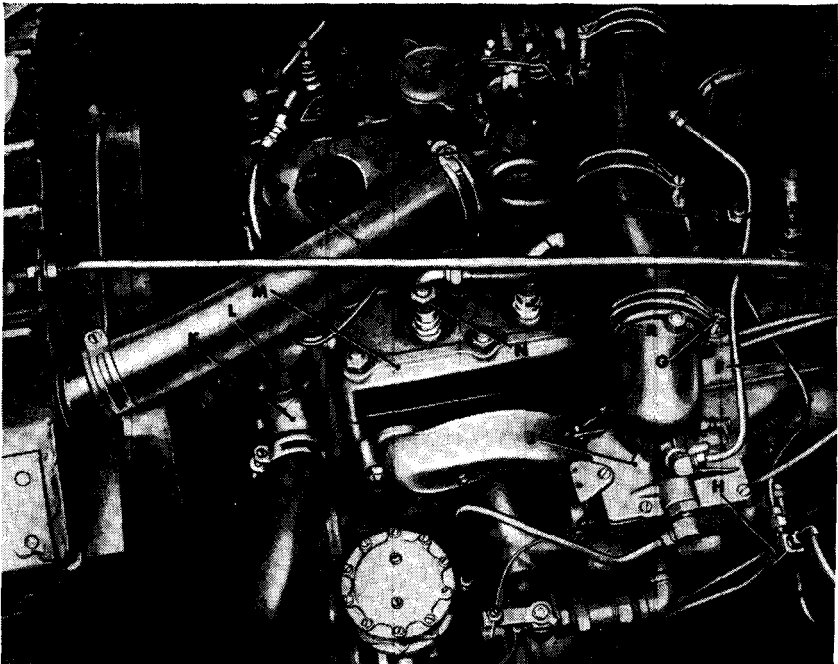

A — SET SCREW
B — AIR INTAKE PIPE WITH VENT VALVE
 AND BRACKET ASSY
C — VENT LINE
D — CLIP
E — SPEED NUT
F — VACUUM HOSE
G — HOSE CLAMP SCREW
H — TEE

J — CARBURETOR ASSY
K — WATER PUMP ASSY
L — BY-PASS HOSE
M — CYLINDER HEAD
N — SPARK PLUG CABLE TERMINAL NUT
P — WATER INLET HOSE
Q — THERMOSTAT HOUSING
R — SPARK PLUG

RA PD 181521

Figure 23. Cylinder head removal and installation—left side.

fig. 23), by unscrewing the nuts at both ends of the line and removing the speed nut (E, fig. 23) and clip (D, fig. 23) on top of the cylinder-head stud nut.

- (4) Loosen the setscrew (F) securing the air cleaner control valve control wire (C) to the swivel (G) and pull the wire out of the swivel. Loosen the hose clamp screw (J), on the control valve hose (H), at the crankcase oil filler pipe assembly (S).
- (5) Remove the cylinder-head stud nut securing the air intake pipe bracket (R) to the top of the cylinder head. Loosen the hose clamp screws (G, fig. 23) and slide the air intake pipe with vent valve and bracket assembly (B, fig. 23) off the carburetor and at the air cleaner. Lift the air intake pipe assembly upward, sliding the control valve hose off at the oil filler pipe connection, and remove the pipe assembly.

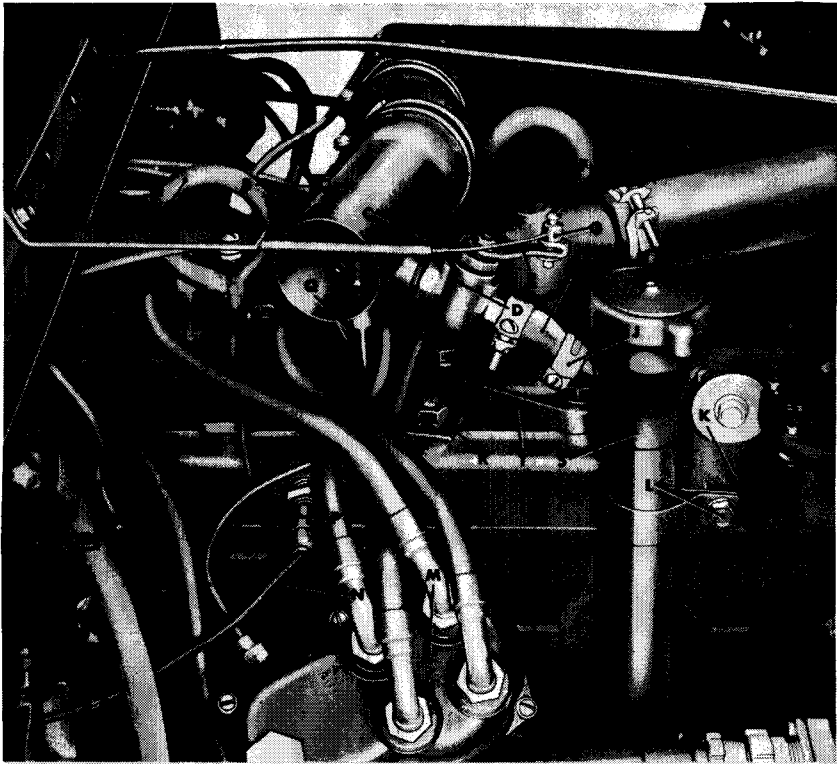

- | | |
|---|---|
| A — LIFTING HOOK | J — HOSE CLAMP SCREW |
| B — AIR INTAKE PIPE WITH VENT VALVE AND BRACKET ASSY | K — MOUNTING BRACKET (ON ENGINE) |
| C — AIR CLEANER CONTROL VALVE CONTROL WIRE | L — FLAT WASHER SCREW |
| D — AIR CLEANER CONTROL VALVE ASSY | M — DISTRIBUTOR WITH COIL ASSY |
| E — CONTROL VALVE LEVER | N — WATER TEMPERATURE SENDING UNIT CABLE |
| F — SET SCREW | P — WATER TEMPERATURE SENDING UNIT |
| G — AIR CLEANER CONTROL VALVE CONTROL WIRE SWIVEL | Q — VENT LINE |
| H — CONTROL VALVE HOSE | R — AIR INTAKE PIPE BRACKET |
| | S — CRANKCASE OIL FILLER PIPE ASSY |
| | T — THERMOSTAT HOUSING |

RA PD 181522

Figure 24. Cylinder head removal and installation—right side.

- (6) Unscrew the spark plug cable terminal nuts (N, fig. 23) securing the cables to the spark plugs (R, fig. 23). Remove cables from the plugs and pull them toward the right side of the vehicle and away from the cylinder head. Remove the plugs, using a deep socket, and discard the spark plug gaskets. Disconnect the water temperature sending unit cable (N) from the water temperature sending unit (P) by turning the connector plug on the end of the cable counterclockwise and pulling it out.
- (7) Remove the flat washer screw (L) securing the crankcase oil filler pipe support bracket and the mounting bracket

(on engine) (K) to the right side of the cylinder head. Remove the three cylinder-head stud nuts securing the mounting bracket (on engine) to the cylinder head and swing the oil filter assembly, with the mounting bracket attached, toward the front of the vehicle and away from the cylinder head.

- (8) Remove the second cylinder-head stud nut from the right rear of the cylinder head. Remove the second and third nuts securing the lifting hook (A) at the rear center of the head and remove the lifting hook.
- (9) Remove the remaining cylinder-head stud nuts and lift the cylinder head up and off the cylinder block.
- (10) Remove and discard the cylinder head gasket.

b. Cleaning and Inspection. Clean the cylinder-head gasket contact surfaces of the cylinder block and cylinder head thoroughly, checking for, and smoothing any, burrs or nicks. Clean carbon deposits from the cylinder head and the top of the pistons, making sure no loose carbon is left on top of the pistons. Check the cylinder-head studs in the cylinder block for rust or corrosion and clean if necessary.

c. Installation.

- (1) Using cylinder-head studs 10 and 12 (fig. 25) as pilot studs for correct positioning, place a new cylinder-head gasket over the cylinder head studs. Position cylinder head on top of gasket being careful not to damage the threads on the studs.
- (2) Start eight $\frac{7}{16}$ -inch cylinder-head stud nuts on studs 3, 4, 6, 8, 11, 12, 13, and 14 (fig. 25) and screw the nuts on fingertight.

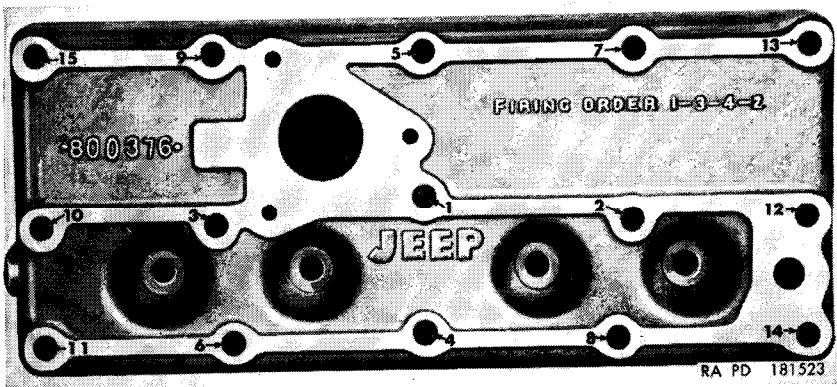

Figure 25. Cylinder-head nut tightening sequence.

- (3) Place the mounting bracket (on engine) (K), with oil filter assembly over cylinder-head studs 9, 10, and 15 (fig. 25) and screw nuts on studs fingertight.
- (4) Place the lifting hook (A) over the cylinder-head studs 1, 2, and 7 (fig. 25) and screw $\frac{7}{16}$ -inch nuts on studs fingertight.
- (5) Position the air intake pipe with vent valve and bracket assembly (B) in the vehicle. Slide the control valve hose (H) onto the hose connection on the crankcase oil filler pipe assembly (S) and place the air intake pipe bracket (R) over the No. 5 stud (fig. 25) and screw $\frac{7}{16}$ -inch nut on stud fingertight. Tighten the hose clamp screw (J) securing the control valve hose (H) to the filler pipe. Slide the air intake pipe hose onto the carburetor and the air cleaner. Secure the hose clamp screws (G, fig. 23) at each end of the pipe assembly.
- (6) Slide the air cleaner control valve control wire (C) into the air cleaner control valve control wire swivel (G) on the control valve lever (E). Make sure deep-water fording vent valve control (H, fig. 7) on instrument panel is pushed all the way in. Position control valve lever with the swivel toward the front of the vehicle. Tighten the set screw (F) securing the control wire to the swivel.
- (7) Tighten all cylinder-head stud nuts to torque of 65–75 pound-feet in the sequence shown in figure 25 to secure the cylinder head to the cylinder block and the mounting bracket (on engine), lifting hook, and air intake pipe bracket to the cylinder head.
- (8) Install the $\frac{5}{16} \times \frac{5}{8}$ flat washer screw (L) through the crankcase oil filler pipe support bracket into the mounting bracket (on engine) (K) and tighten.
- (9) Clean, adjust, and install the spark plugs and connect the spark plug cables (par. 145). Connect the water temperature sending unit cable (N) by pushing the connector plug on the end of the cable into the sending unit receptacle and turning the connector clockwise to secure it to the sending unit.
- (10) Position the vent line (Q), between the distributor and the air intake pipe with vent valve and bracket assembly (B), in place and screw the nuts on both ends of the line into the fittings. Position the vacuum hose (F, fig. 23), between the distributor and the tee (H, fig. 23), in place with clip (D, fig. 23) over cylinder-head stud

nut No. 2 (fig. 25). Screw speed nut (E, fig. 23) onto the stud to secure the clip. Screw nuts at both ends of the line into fittings. Position the vent line (C, fig. 23) between the carburetor assembly (J, fig. 23) and the air intake pipe with vent valve and bracket assembly (B, fig. 23) and screw the nuts at each end of the line into the fittings.

- (11) Install the bypass hose (L, fig. 23) between the water pump assembly (K, fig. 23) and the cylinder head (M, fig. 23) and the water inlet hose (P, fig. 23) between the radiator and thermostat housing (Q, fig. 23). Tighten the four hose clamp screws securing the bypass and inlet hose.
- (12) Fill the cooling system (par. 121) and check for water leaks. Start and warm up the engine until normal operating temperature is reached (par. 120). After warming up the engine, shut the engine off and tighten cylinder-head stud nuts again (7) above.

104. Cylinder Head Replacement

a. Removal.

- (1) Remove the cylinder head (par. 103a).
- (2) Remove thermostat housing (Q, fig. 23 and par. 126a).
- (3) Remove the water temperature sending unit (P, fig. 24) by unscrewing the unit from the cylinder head.

b. Cleaning and Inspection. Clean and inspect (par. 103b).

c. Installation.

- (1) Install the water temperature sending unit (P, fig. 24) in the cylinder head.
- (2) Install the thermostat housing (Q, fig. 23 and par. 126b).
- (3) Install the cylinder head on the engine (par. 103c).

105. Valve Tappet Clearance Adjustment (fig. 26)

a. Remove the spark plugs (par. 145).

b. Remove the valve tappet compartment cover and gasket (par. 106).

c. When valve adjustment is made, valve must be fully closed. To be sure both valves of any particular cylinder are closed, move the piston of that cylinder to top dead center of compression stroke. This is done as follows—place a thumb over the spark plug hole and press slightly. Turn the crankshaft by hand. When pressure is felt against the thumb, the compression stroke has started. Continue turning the crankshaft, allowing the pressure to escape slowly past the thumb, until the top of the com-

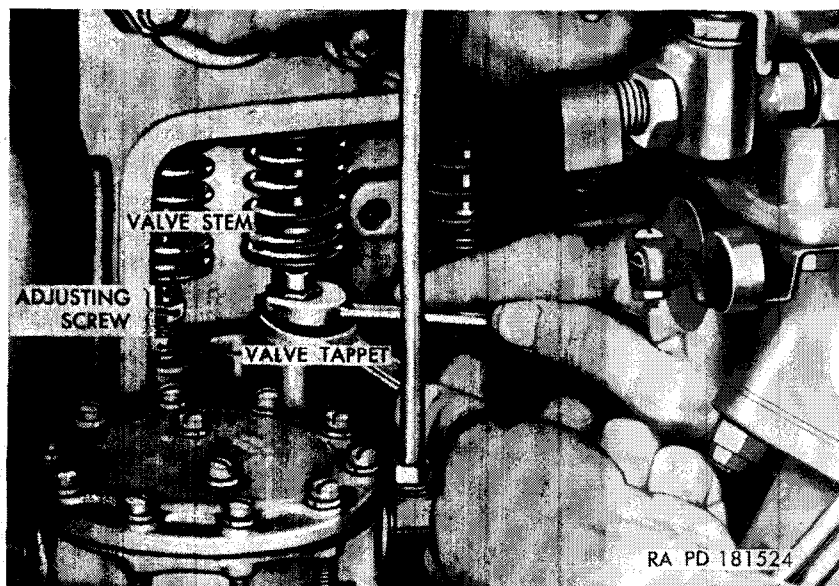

Figure 26. Adjusting valve tappets.

pression stroke is reached, at which point, the pressure against the thumb will cease to build up further. Do not turn crankshaft beyond this point. Both valves for this cylinder are now fully closed.

d. Check the clearance between each valve tappet adjusting screw and the bottom of the valve stem with a feeler gage. The clearance should be 0.016 inch. If the clearance is not correct, hold the tappet from turning with an open end wrench and turn the adjusting screw with another wrench. Turn the screw clockwise, as viewed from the top, to increase clearance and counter-clockwise to decrease clearance. Turn screw only a slight amount at a time and check clearance after each change. Continue process until the clearance of both valves is correct.

e. Repeat operations *c* and *d* above for each of the other three cylinders.

f. Install the valve tappet compartment cover and gasket (par. 106).

g. Install the spark plugs (par. 145).

h. Start the engine, warm to operating temperature, and check for smooth operation. Check valve tappet compartment cover for oil leaks.

106. Valve Tappet Compartment Cover and Gasket

a. Removal (fig. 27).

- (1) Unscrew the vent line nut from the elbow on the crankcase control valve assembly. Remove the front cover bolt securing the crankcase vent body and valve tappet compartment cover to the cylinder block. Remove the vent body and gasket with the elbow and the vent line connecting the compartment cover and the elbow on the control valve assembly. Discard gasket.

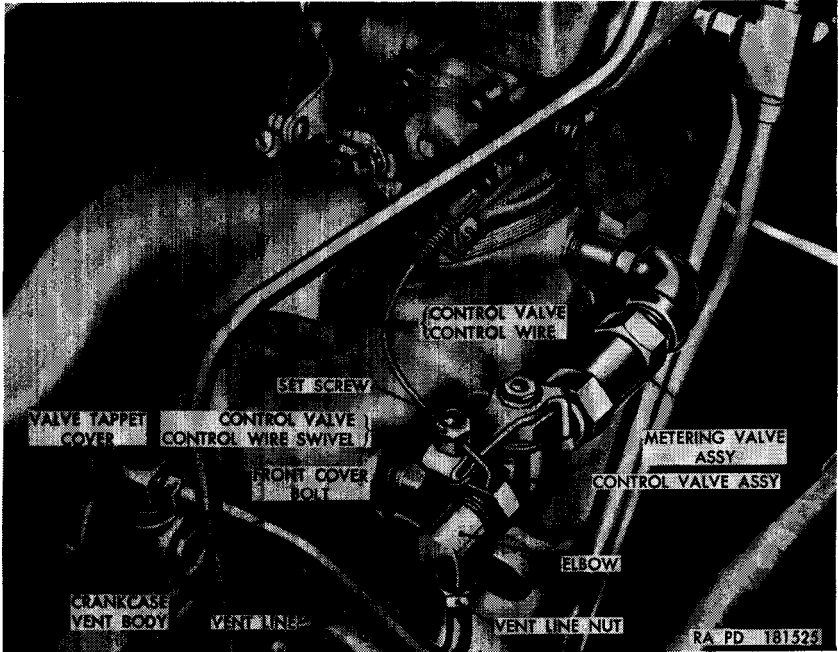

Figure 27. Crankcase control valve and vent metering valve assemblies—installed.

- (2) Remove the compartment cover screw securing the cover to the cylinder block at the rear of the cover.
- (3) Slide the rear of the cover toward the rear of the vehicle and down toward the transmission until the front of the cover has cleared the rear of the intake and exhaust manifold assembly. Pull the front of the cover out from the cylinder block to clear the manifold assembly, then pull the cover forward, or toward the front, to remove from the vehicle; remove the old gasket.

b. Installation.

- (1) Clean the valve tappet compartment cover gasket surfaces on the cylinder block and the cover, removing any particles of the old gasket. Place a new gasket, securing it with plastic-type gasket cement, on the cover.
- (2) Slide the rear of the cover by the rear of the intake and exhaust manifold assembly, toward the rear of the vehicle, and down toward the transmission. When the front of the cover has cleared the rear of the manifold, push the front toward the cylinder block and behind the manifold and slide the cover forward into position on the block.
- (3) Install $\frac{5}{16}$ x $2\frac{9}{16}$ compartment cover screw through the cover at the rear end and turn it into the cylinder block fingertight to secure the cover and the gasket to the block.
- (4) Place a new gasket between the crankcase vent body and the cover. Slide a new gasket on the front cover bolt and insert the $\frac{5}{16}$ x $3\frac{11}{16}$ bolt through the vent body, the cover, and gasket and screw the bolt into the cylinder block fingertight. Line up the vent body and gasket on the compartment cover; the compartment cover and gasket on the cylinder block, and the vent line with the elbow and tighten the cover bolt and the compartment cover screw to secure the vent body and cover to the cylinder block.
- (5) Screw the vent line nut into the elbow on the crankcase control valve assembly and tighten.

107. Crankcase Control Valve, Air Cleaner Control Valve, and Crankcase Vent Metering Valve Assemblies

a. Air Cleaner Control Valve Assembly (fig. 28).

(1) *Removal.*

- (a) Loosen the set screw securing the air cleaner control valve control wire to the air cleaner control valve control wire swivel and pull the wire out of swivel.
- (b) Loosen the hose clamp screw at both ends of the control valve hose and remove the hose.
- (c) Unscrew the air cleaner control valve assembly from the air intake pipe and remove the valve assembly.

(2) *Installation.*

- (a) Screw the air cleaner control valve assembly onto the air intake pipe with the control valve lever at top.

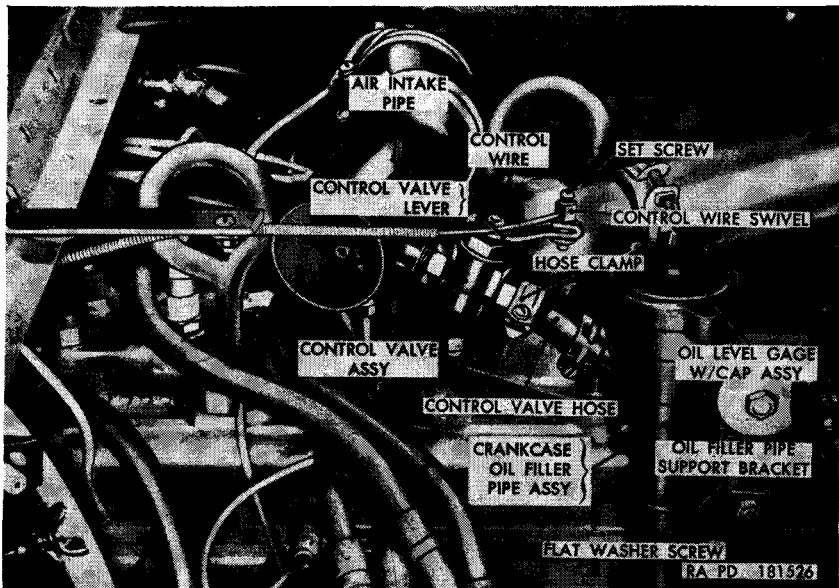

Figure 28. Air cleaner control valve assembly—air cleaner removed.

- (b) Install the control valve hose between the crankcase oil filler pipe assembly and the control valve and tighten hose clamp screws securing the hose.
- (c) Push the control wire through the swivel and make sure that the deep-water fording vent valve control (H, fig. 7), on the instrument panel, is pushed all the way in. Position the lever toward the front of the vehicle and tighten the set screw on the control wire.

b. Crankcase Control and Vent Metering Valve Assemblies (fig. 27).

- (1) *Removal.* Remove the crankcase control valve and vent metering valve assemblies (par. 108a(4), (5), and (6)).
- (2) *Cleaning.* Every 6 months, disassemble the control valve and clean the valve, seat, and all orifices with dry-cleaning solvent or volatile mineral spirits. Also inspect and clean all connecting lines.
- (3) *Installation.* Install the crankcase control valve and vent metering valve assemblies (par. 108b(5), and (6)).

108. Intake and Exhaust Manifold Assembly Replacement

Note. The key letters noted in parentheses are in figure 29.

a. Removal.

- (1) Remove carburetor (par. 129b).

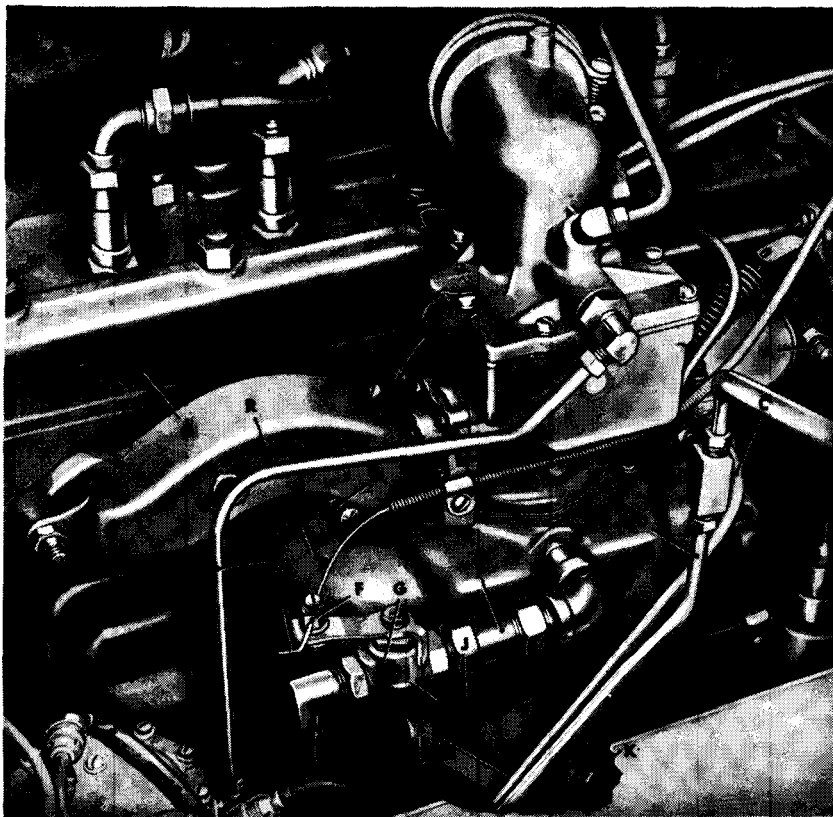

A - NUT
B - NUT
C - FUEL AND VACUUM PUMP-TO-INTAKE MANIFOLD LINE
D - FUEL AND VACUUM PUMP-TO-TEE LINE
E - CRANKCASE VENT METERING VALVE ASSY
F - CRANKCASE CONTROL VALVE CONTROL WIRE SWIVEL
G - CRANKCASE CONTROL VALVE ASSY
H - HEAT CONTROL VALVE SPRING STOP

J - LOCKWASHER SCREW
K - BOLT
L - NUT
M - VENT LINE
N - CRANKCASE CONTROL VALVE CONTROL WIRE
P - FUEL LINE
Q - INTAKE MANIFOLD
R - EXHAUST MANIFOLD
S - CYLINDER BLOCK

RA PD 181527

Figure 29. Intake and exhaust manifold removal or installation.

- (2) Unscrew the nuts at each end and remove the fuel and vacuum pump-to-intake manifold line (C).
- (3) Remove fuel and vacuum pump-to-tee line (D) by unscrewing nut at each end of the line.
- (4) Loosen the set screw securing the crankcase control valve control wire (N) to the crankcase control valve control wire swivel (F) and pull the control wire out of the swivel.

- (5) Remove the vent line (M) between the crankcase control valve assembly (G) and the crankcase vent body (fig. 27) by unscrewing nut at each end of the line.
- (6) Remove the crankcase control valve and vent metering valve assemblies (G and E) by unscrewing the pipe nipple from the intake manifold.
- (7) Remove the nut from the bolt (K), and nut (L) from the stud, connecting the exhaust pipe to the exhaust manifold.
- (8) Remove the four nuts (B) one at the front of the intake manifold; one at the rear of the intake manifold; and two, with flat washers, at the center securing the intake and exhaust manifold assembly to the cylinder block. Remove the three nuts (A) securing the exhaust manifold to cylinder block.
- (9) Slide the intake and exhaust manifold assembly away from the block and off the studs and lift out of the vehicle.
- (10) Remove the four lockwasher screws (J) attaching the intake and exhaust manifolds (Q and R). Remove heat control valve spring stop (H). Remove gasket between the intake and exhaust manifolds and clean the contacting surfaces. Also clean the gasket contacting surfaces on cylinder block and intake and exhaust manifold assembly.

b. Installation.

- (1) Before installation, the new intake and exhaust manifolds must be fastened together. Place the surfaces which contact the cylinder block on a flat surface or plate. Insert a new intake-to-exhaust manifold gasket between the intake and the exhaust manifolds. Place heat control valve spring stop (H) over one $\frac{5}{16}$ x 1 lockwasher screw (J) and screw into the left front hole fingertight. Start the other three $\frac{5}{16}$ x 1 lockwasher screws (J) through the exhaust manifold and into the intake manifold and tighten all four screws with equal tension.
- (2) Place a new intake and exhaust manifold gasket over studs on cylinder block. Place intake and exhaust manifold assembly over studs.
- (3) Screw the three $\frac{3}{8}$ -inch nuts (A) onto the manifold studs but do not tighten. Place $1\frac{3}{32}$ ID flat washers on the two center studs and screw on two $\frac{3}{8}$ -inch nuts (B). Screw one $\frac{3}{8}$ -inch nut (B) on stud at front of the intake manifold and one $\frac{3}{8}$ -inch nut (B) on stud at rear of the intake manifold. After all nuts (A and B) are in place

on the studs, tighten them a little at a time and with equal tension to secure intake and exhaust manifold assembly to cylinder block.

- (4) Insert a new exhaust pipe flange gasket between the pipe flange and the exhaust manifold flange. Lift the exhaust pipe up and over the stud in the exhaust manifold flange and screw $\frac{3}{8}$ -inch nut (L) onto the stud part way. Insert $\frac{3}{8}$ x $1\frac{1}{2}$ bolt (K) through the exhaust manifold flange, gasket, and pipe flange and screw on $\frac{3}{8}$ -inch nut. Tighten nut (L) and the nut on the bolt (K) with equal tension to secure exhaust pipe to the manifold assembly.
- (5) Install the crankcase control valve and vent metering valve assemblies (G and E) on intake manifold by screwing the pipe nipple into the manifold to the position shown.
- (6) Insert the crankcase control valve control wire (N) through the crankcase control valve control wire swivel (F) and tighten the set screw securing wire to swivel. Position the vent line (M) between the crankcase control valve and the crankcase vent body (fig. 27). Screw nut into the fitting at both ends of the line and tighten.
- (7) Position fuel and vacuum pump-to-tee line (D) between the fuel and vacuum pump and the tee and tighten the two nuts.
- (8) Position fuel and vacuum pump-to-intake manifold line (C) between the fuel and vacuum pump and the intake manifold and tighten the two nuts.
- (9) Install carburetor (par. 129c).

109. Intake and Exhaust Manifold Gaskets

(fig. 29)

a. Intake and Exhaust Manifold Gasket (Manifold-to-Cylinder Block). Replace the intake and exhaust manifold gasket (manifold-to-cylinder block) (par. 108).

b. Intake and Exhaust Manifold Gasket (Manifold-to-Manifold). Replace intake and exhaust manifold gasket (manifold-to-manifold) (par. 108) except that the old manifolds are used instead of new ones.

110. Oil Filter Assembly

(fig. 30)

a. Removal.

- (1) Disconnect the oil filter inlet flexible oil line assembly and fitting from the oil filter head with cartridge assembly

by unscrewing the nut from the fitting and unscrewing the fitting from the head. Disconnect the oil filter outlet flexible oil line assembly by unscrewing the nut from the fitting on the timing gear cover assembly. Remove the oil filter outlet flexible oil line assembly and elbow from the head with cartridge assembly by unscrewing the elbow from the head.



Figure 30. Oil filter assembly—installed.

- (2) Remove the two flat washer screws with large flat washers, holding the mounting bracket (on oil filter) to the mounting bracket (on engine), from the two speed nuts. Remove the oil filter assembly with the mounting bracket (on oil filter) from the vehicle. Loosen the screw and nut securing the mounting bracket to the filter and slide the bracket off the filter.

b. Installation.

- (1) Screw the oil filter inlet flexible oil line fitting into the oil filter head with cartridge assembly at the position indicated by an arrow pointing toward the center of

the head. Screw the oil filter outlet flexible oil line elbow, with flexible oil line, into the oil filter head with cartridge at the position indicated by an arrow pointing to the outside edge of the head.

- (2) Put the oil filter assembly into the mounting bracket (on oil filter) but do not tighten the screw and nut in the bracket. Position the mounting bracket (on oil filter) on the mounting bracket (on engine). Place a $1\frac{1}{32}$ -inch flat washer on each of the two $\frac{5}{16}$ -10 x $\frac{5}{8}$ (Acme) flat washer screws. Put the screws through the holes in the mounting bracket (on oil filter) and screw into the J-type speed nuts on mounting bracket (on engine). Position the oil filter in the mounting bracket, aligning the inlet fitting on the oil filter with the inlet flexible oil line, and tighten the screw and nut securing the mounting bracket to the oil filter assembly.
- (3) Connect the inlet flexible oil line to the oil filter by screwing the nut on the end of the line into the fitting on the oil filter. Connect the outlet flexible oil line to the timing gear cover assembly by screwing the nut on the end of the line into the fitting in the cover.
- (4) Start the engine and run it for a few minutes to fill the oil filter assembly and check for oil leaks around the flexible oil line connections and the filter.

Note. The oil filter inlet flexible oil line is slack enough to permit the engine fan blast to force the line into constant contact with the manifold elbow. To prevent damage by burning, move the oil filter clockwise within its mounting bracket to shorten the line enough to keep it clear of the manifold elbow.

111. Oil Filter Head With Cartridge Assembly (fig. 30)

a. Removal.

- (1) Disconnect the oil filter inlet flexible oil line assembly and fitting from the oil filter head with cartridge assembly by unscrewing the nut from the fitting and unscrewing the fitting from the head. Disconnect the oil filter outlet flexible oil line assembly by unscrewing the nut from the fitting on the timing gear cover assembly. Remove the oil filter outlet flexible oil line assembly and elbow from the head with cartridge assembly by unscrewing the elbow from the head.
- (2) Remove six bolts and nuts securing the head and the reinforcing ring to the sump and lift the head with cartridge assembly out of the sump.

b. Cleaning. Remove the pipe plug from the bottom of the sump. Drain the sump thoroughly and wipe dry. Wash the oil filter head with cartridge assembly in dry-cleaning solvent or volatile mineral spirits. While cartridge is submerged in cleaning agent, hold the head and rotate the handle to work all dirt out of the cartridge. Allow the cartridge to drain.

Caution: Never use compressed air to dry cartridge, as air under pressure can cause serious damage.

c. Installation.

- (1) Screw the elbow with outlet flexible oil line into the cartridge head at the position indicated by an arrow pointing to the outer edge and tighten elbow. Place a new gasket in the recess of the head. Insert the head with cartridge assembly in the sump with the outlet pointing forward as shown in figure 30. Aline the holes in the reinforcing ring with the holes in the cartridge head, insert six No. 12 x $\frac{3}{4}$ bolts through the head and reinforcing ring, and screw into the six No. 12 nuts on the underside of the reinforcing ring. Screw the inlet fitting into the head and screw the nut on the end of the inlet flexible oil line into the fitting.
- (2) Screw the nut in the end of the outlet flexible oil line into the fitting in the timing gear cover assembly.
- (3) Start the engine to fill the oil filter assembly with oil and check the assembly and flexible oil lines for possible leaks.

112. Oil Filler Pipe Assembly (fig. 28)

a. Removal. Remove the oil level gage with cap assembly from the crankcase oil filler pipe assembly. Loosen the hose clamp screws on the control valve hose connecting the oil filler pipe to the air cleaner control valve assembly and remove the hose. Remove the flat washer screw securing the oil filler pipe support bracket to the mounting bracket (on engine) and cylinder head, and remove the oil filler pipe.

Note. The filler pipe is a drive fit in crankcase. Some difficulty may be experienced in removal. The pipe may be loosened by tapping front and rear side alternately and, at the same time, pulling straight up on pipe.

b. Installation. Do not install a used filler pipe, as a tight fit in crankcase is necessary to prevent oil leakage. Insert end of new pipe in crankcase opening, with the flat side, at center portion of pipe, facing the generator. Tap pipe into place, using a soft hammer or wood block. Use care to avoid damage to upper end of pipe. Install the control valve hose connecting the

filler pipe to the air cleaner control valve assembly. Tighten hose clamp screws securing the hose. Install and tighten $\frac{5}{16} \times \frac{5}{8}$ flat washer screw securing the oil filler pipe support bracket to the mounting bracket (on engine). Install the oil level gage with cap assembly on filler pipe. Run engine until normal operating temperature (160°–180° F.) is reached and check oil filler pipe at lower end for leaks.

113. External Lines and Fittings

- a. External lines consist of flexible and solid types.
- b. Fittings, as termed, consist of elbows, nipples, tees, and a shutoff valve.
- c. The lines and fittings for various systems are covered in (1) through (6) below.
 - (1) *Brake system.* See paragraph 245.
 - (2) *Carburetor assembly.* See paragraph 135.
 - (3) *Oil filter assembly.* See paragraph 110.
 - (4) *Fuel and air intake system.* See paragraphs 135 and 143.
 - (5) *Crankcase and air cleaner control valve and vent metering valve assemblies.* See paragraph 107.
 - (6) *Windshield wipers.* See paragraphs 143 and 265.

Section VI. ENGINE REMOVAL AND INSTALLATION

114. General

For ease of maintenance, the engine, clutch, transmission, transfer, and radiator are removed as a unit, referred to as the power plant (figs. 31 and 32). The power plant must be removed before the engine can be separated from the other units.

115. Coordination With Ordnance Maintenance Unit

Refer to paragraph 2 for information on coordination with an ordnance maintenance unit.

116. Power Plant Removal

a. *Preliminary.* Remove the hood (par. 261). Disconnect battery-to-battery ground cable (fig. 68) from battery "A" located in the engine compartment.

Note. It is not necessary to drain the radiator, crankcase, transmission, or transfer before removing the power plant unless vehicle is equipped with winch and power-take-off.

Close the fuel shutoff valve (P, fig. 34).

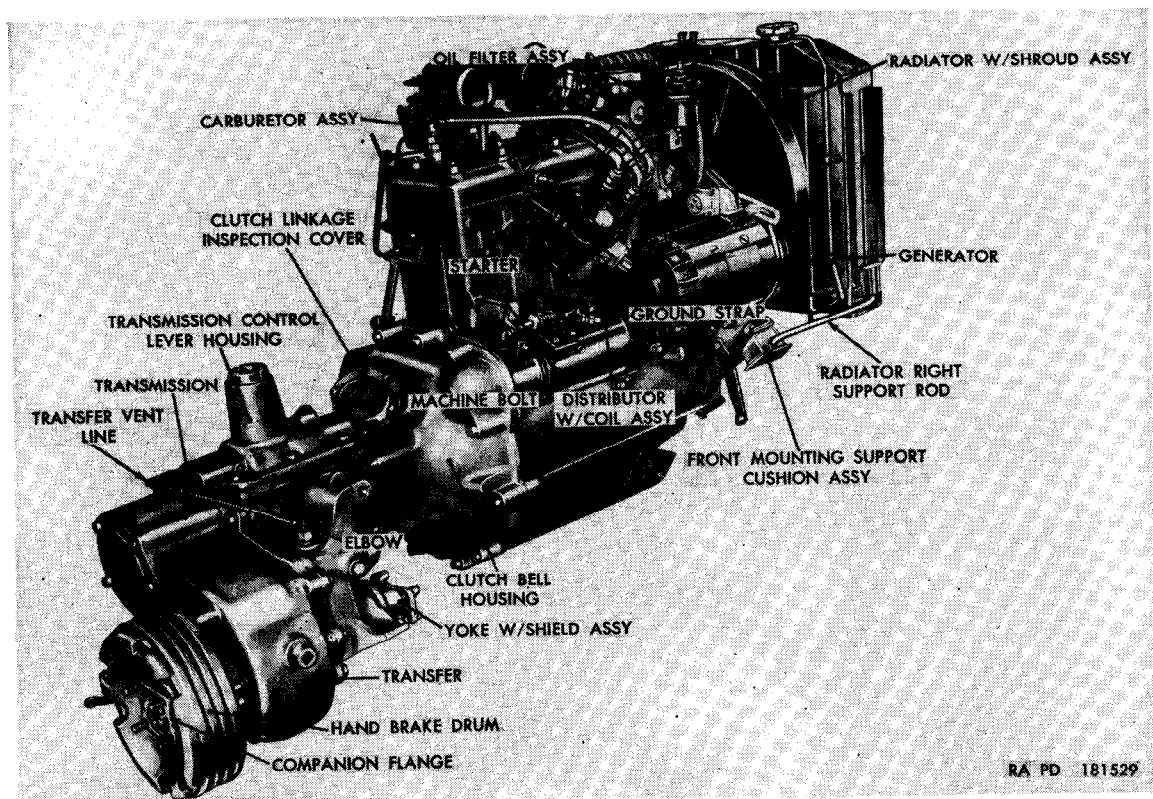

Figure 31. Right rear view of power plant as removed.

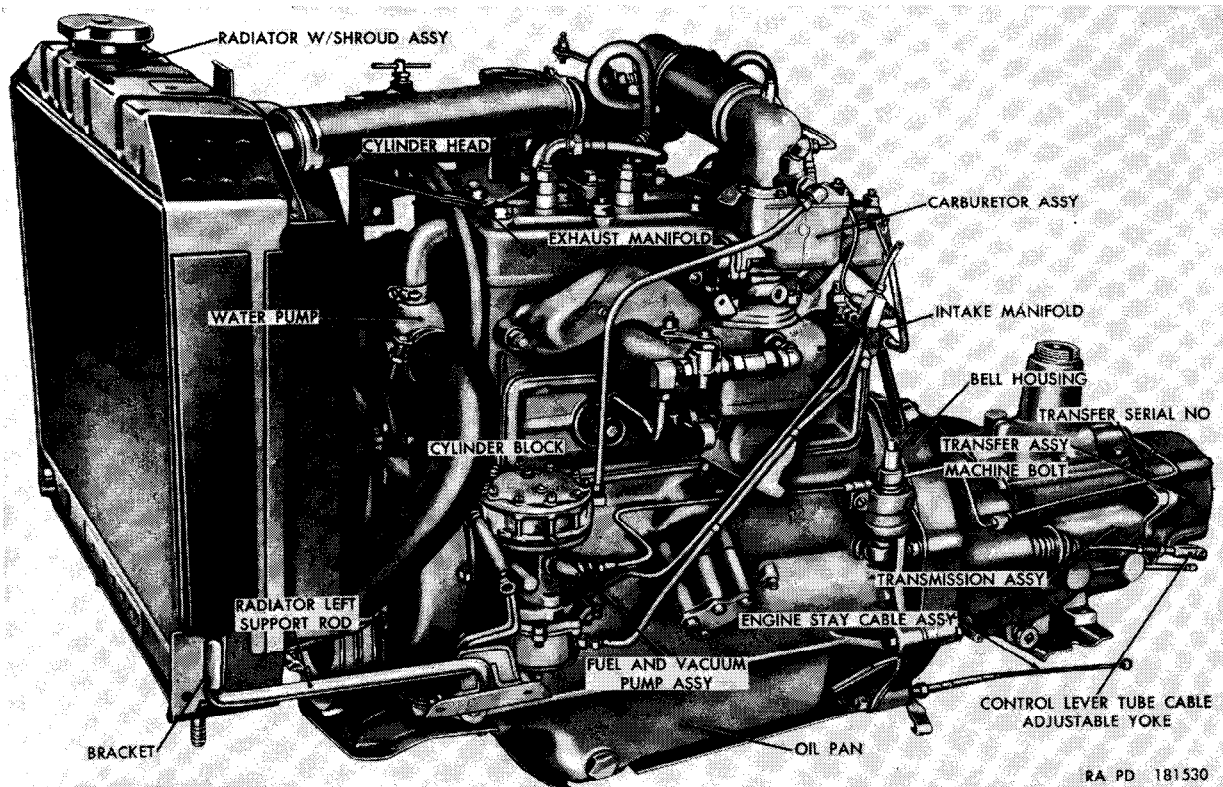

Figure 32. Left front view of power plant as removed.

b. Operations at Front of Vehicle.

- (1) Remove radiator guard (par. 263).
- (2) Remove the two nuts and flat washers from the radiator hold-down studs (fig. 41) securing the radiator to the vehicle frame and remove the radiator cushions.

c. Operations at Right Side of Vehicle.

Note. The key letters noted in parenthesis are in figure 33, except where otherwise indicated.

- (1) Pull windshield wiper hose (A) off windshield wiper vent line (B) and unscrew vent line nut from tee (E).
- (2) Unscrew nut on master cylinder vent line (F) and remove line from the connector in tee (E).

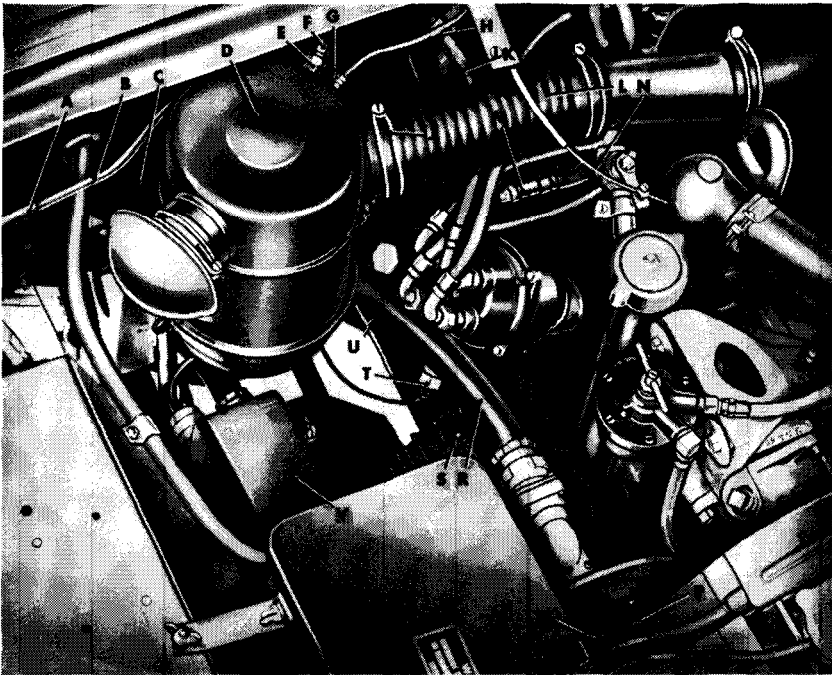

A — WINDSHIELD WIPER HOSE
B — WINDSHIELD WIPER VENT LINE
C — AIR CLEANER RIGHT SUPPORT BRACKET ASSY
D — AIR CLEANER ASSY
E — TEE
F — MASTER CYLINDER VENT LINE
G — CONNECTOR
H — FUEL TANK VENT LINE
J — HOSE CLAMP
K — BATTERY-TO-STARTER CABLE
L — AIR CLEANER-TO-AIR INTAKE PIPE FLEXIBLE HOSE

M — WATER TEMPERATURE SENDING UNIT
N — AIR CLEANER CONTROL VALVE CONTROL WIRE
P — FRONT MOUNTING SUPPORT CUSHION
Q — ENGINE FRONT PLATE-TO-FRAME GROUND STRAP
R — GENERATOR-TO-GENERATOR REGULATOR CABLE
S — GENERATOR
T — NUT
U — STARTER SWITCH
V — GENERATOR REGULATOR

RA PD 181531

Figure 33. Disconnect points at right side of vehicle.

- (3) Unscrew nut on fuel tank vent line (H), and remove line from connector (G).
- (4) Loosen hose clamps (J) securing the air cleaner-to-air intake pipe flexible hose (L) in position and remove hose.
- (5) Loosen the two wing screws securing the air cleaner assembly (D) to the left support bracket assembly. Remove the two wing screws and lockwashers securing air cleaner assembly to the right support bracket assembly (C) and remove air cleaner assembly.
- (6) Disconnect cable No. 33 (fig. 85) from the water temperature sending unit (M) by turning cable plug counterclockwise and withdrawing from receptacle.
- (7) Loosen the set screw securing air cleaner control valve control wire (N) to swivel and withdraw wire from swivel.
- (8) Disconnect cable No. 12 from the wiring harness filter receptacle assembly by unscrewing nut (T) from housing.
- (9) Unscrew the connectors securing the generator-to-generator regulator cable (R) from generator (S) and generator regulator (V) and remove cable.
- (10) Remove the nut and lockwasher securing the battery-to-starter cable and generator regulator cable (fig. 63) to starter switch (U) and remove cables from switch.
- (11) Remove the self-locking nut, flat washer, and bolt securing the engine front plate-to-frame ground strap (Q). Remove the self-locking nut, flat washers, and bolt securing the front mounting support cushion (P) to vehicle frame.

d. Operations at Left Side of Vehicle.

Note. The key letters noted in parentheses are in figure 34, except where otherwise indicated.

- (1) Loosen the nuts securing the brace rod (A) to radiator, and remove the nut and lockwasher securing rod to vehicle cowl. Remove rod and install washer and nut to prevent loss.
- (2) Unscrew the nut securing the fuel line to the flexible fuel line (S) and separate the lines.
- (3) Remove the nuts from the stud and bolt securing the exhaust pipe (V) to the exhaust manifold (B) and remove the bolt. Press on flange of exhaust pipe to free it from the stud in the exhaust manifold and remove exhaust pipe flange gasket.

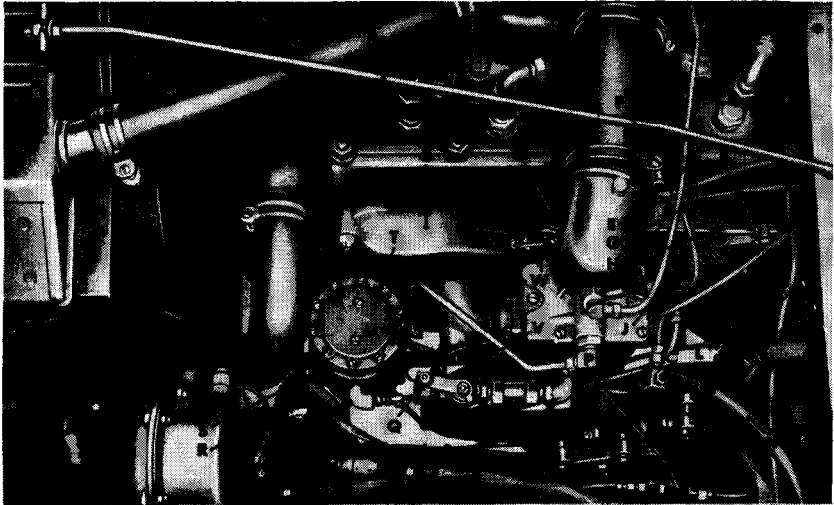

A - BRACE ROD	M - WINDSHIELD WIPER LINE
B - EXHAUST MANIFOLD	N - WINDSHIELD WIPER HOSE
C - THROTTLE CONTROL WIRE	P - FUEL SHUT-OFF VALVE
D - CHOKE CONTROL WIRE	Q - CRANKCASE CONTROL VALVE
E - THROTTLE CONTROL CONDUIT BRACKET	CONTROL WIRE SWIVEL
F - THROTTLE CONTROL CONDUIT	R - FRONT MOUNTING SUPPORT CUSHION
G - CHOKE CONTROL CONDUIT	S - FLEXIBLE FUEL LINE
H - ACCELERATOR CONTROL ROD	T - FUEL AND VACUUM PUMP ASSY
J - ACCELERATOR PEDAL RETURN SPRING	U - CRANKCASE CONTROL VALVE CONTROL
K - ACCELERATOR CROSS SHAFT	WIRE
L - OIL PRESSURE GAGE SENDING UNIT	V - EXHAUST PIPE
	W - THROTTLE VALVE SHAFT

RA PD 181532

Figure 34. Disconnect points at left side of vehicle.

- (4) Loosen the setscrew securing the crankcase control valve control wire (U) to the crankcase control valve control wire swivel (Q) and withdraw wire from swivel. Remove the nut and bolt from the clip securing the conduit for the control wire (fig. 27) to the support strap located at carburetor front mounting stud and tie control wire to vehicle cowl. Replace the nut and bolt on clip to prevent loss.
- (5) Loosen the set screw securing the stop to the throttle control wire (C) and withdraw wire from shaft (W). Loosen set screw securing the choke control wire (D) to the swivel on the choke valve shaft and withdraw wire from shaft. Remove plain nut and bolt securing the choke control conduit (G) and clamp to the throttle control conduit bracket (E) and remove the choke control conduit. Spread the opening in the throttle control conduit bracket and pull the throttle control conduit free. Tie the conduits to the cowl to prevent damage.

- (6) Unhook the accelerator pedal return spring (J) from the accelerator control rod (H). Remove the cotter pin and flat washer securing control rod to accelerator cross shaft (K). Secure cotter pin and washer to control rod to prevent loss.
- (7) Disconnect cable No. 36 (fig. 85) from oil pressure gage sending unit (L) by turning cable plug counterclockwise and withdrawing it from receptacle.
- (8) Pull windshield wiper hose (N) from windshield wiper line (M).
- (9) Remove the two self-locking nuts, four flat washers, and two bolts securing the front mounting support cushion (R) to vehicle frame.
- (10) Loosen the bolt in the upper end of the brake pedal assembly, pull the pad assembly from the pedal assembly and remove the draft pad and draft pad spring from beneath the upper front floor pan cover.

e. Operations Inside Passenger Compartment.

Note. The key letters noted in parentheses are in figure 35, except where otherwise indicated.

- (1) Remove the gearshift lever knob from gearshift lever (A) and the gearshift lever knobs (B) from the high and low range gearshift lever (J) and front wheel drive gearshift lever (P).
- (2) Loosen the hose clamps (Q and S) and slide transmission gearshift lever boot (R) off gearshift lever (A). Unscrew gearshift lever housing cap and withdraw lever from transmission. Stuff a clean rag in transmission case opening to prevent foreign material from entering.
- (3) Remove the sheet metal screws securing the shift lever housing cover boot ring (L) and slide ring and transfer gearshift levers-to-floor board boot (K) off shift levers.
- (4) Loosen the two lockwasher bolts securing the transfer case bolt access plate (M) to lower front floor pan cover (N) and swing plate to the rear. Reach through access plate opening, unscrew the pivot pin and remove pin and lock washer. Remove the high and low range and front wheel drive gearshift levers (J and P) and gearshift lever springs from transfer.
- (5) Remove the lockwasher bolts securing the steering gear jacket access plate (E) and steering gear jacket access plate seal (D) in position. Separate and remove the access plate, and slide the seal up on the steering gear jacket.

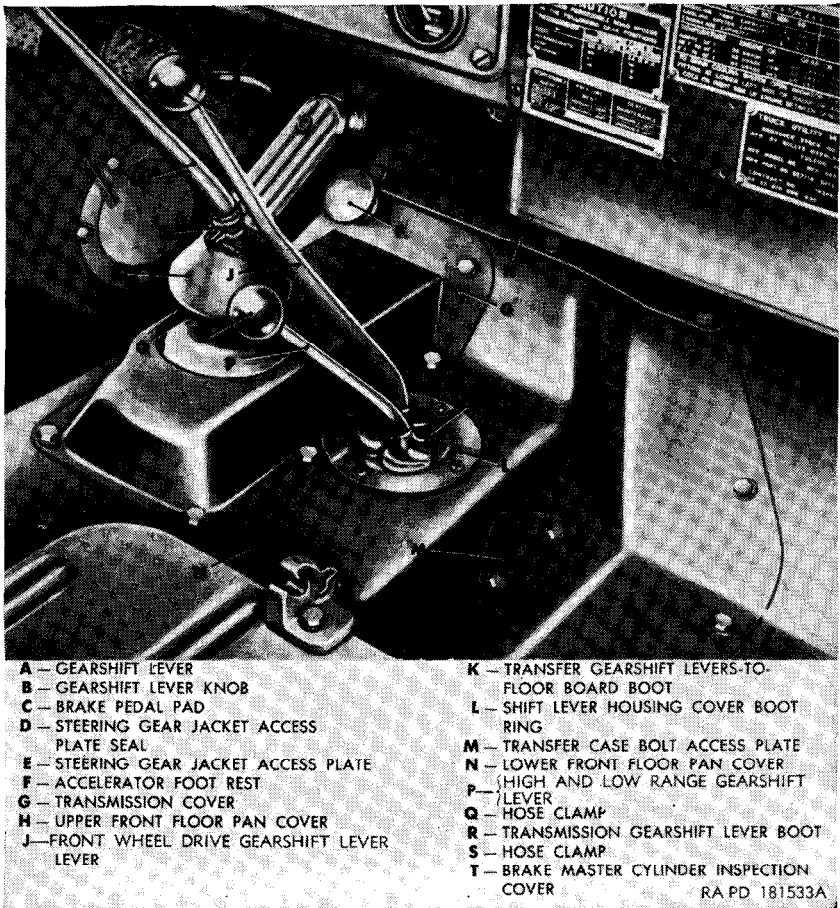

Figure 35. Disconnect points in passenger compartment—floor pan covers installed.

- (6) Remove the lockwasher bolts securing the brake master cylinder inspection cover (T) to the lower front floor pan cover (N) and remove inspection cover.
- (7) Remove the remaining lockwasher bolts securing the upper front floor pan cover (H) in position and remove cover with starter pedal attached.
- (8) Remove the lockwasher bolts and accelerator foot rest (F) securing the transmission cover (G) in position and remove cover.
- (9) Remove the remaining lockwasher bolts securing the lower front floor pan cover (N) in position and remove cover.
- (10) Disconnect universal joint at rear of front propeller shaft (par. 209). Push joint forward on shaft, swing toward right side of vehicle, and tie up out of the way.

- (11) Remove plain nut, bolt, flat washer, and plain washer securing the case support insulator, case support insulator snubber (C, fig. 36), and case support insulator retaining cup in position and remove insulator, snubber, and cup.
- (12) Remove the cotter pin and clevis pin from the clutch control lever tube cable adjustable yoke (fig. 32) and disconnect yoke from the control lever tube.
- (13) Unhook and remove the brake pedal retracting spring (Q, fig. 36).
- (14) For vehicles equipped with winch and power-take-off, unscrew the knob from the power-take-off gearshift control lever (HH, fig. 7). Unscrew the four screws from the grommet retaining plate (NN, fig. 7) and slide the plate and the grommets (LL and MM, fig. 7) up off the gearshift lever. Remove the four screws from the power-take-off shift lever plate and lift the plate with gearshift lever out of the power-take-off.

f. Operations Under Vehicle.

Note. The key letters noted in parentheses are in figure 36, except where otherwise indicated.

- (1) Remove the plain nuts, plain washers, lockwashers and carriage bolts securing the skid plate to engine rear support cross member (F) and remove skid plate.
- (2) Loosen the adjusting nut securing the engine stay cable (H) and lift cable end out of bracket (G).
- (3) Remove the two self-locking nuts from the studs on the rear mounting support cushion (L) to loosen cushion from the engine rear support cross member (F).
- (4) Remove the four plain nuts, flat washers, and lockwashers from bolts (D) securing the engine rear support cross member (F) to the vehicle frame and remove the cross member.
- (5) Unhook and remove the cable retracting spring (R).
- (6) Remove the plain nut and bolt securing the cable housing clamp (J) to the rear mounting bracket (K).
- (7) Remove the cotter pin and clevis pin securing the hand brake rod end yoke (N) to the operating lever (M). Spread open the clip securing the hand brake cable to bell housing and slide cable out of clip.
- (8) Disconnect speedometer cable (E) from the speedometer driven gear sleeve (fig. 90).
- (9) Remove the four nuts and lockwashers securing the universal joint (A), located at the front of the rear propeller

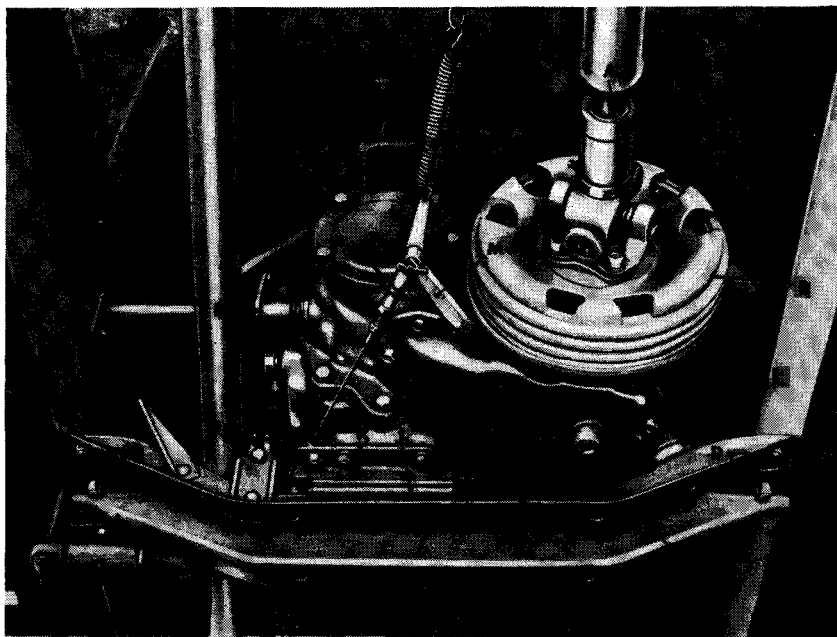

A — UNIVERSAL JOINT
B — HAND BRAKE DRUM
C — CASE SUPPORT INSULATOR SNUBBER
D — MACHINE BOLT
E — SPEEDOMETER CABLE
F — ENGINE REAR SUPPORT CROSS MEMBER
G — BRACKET
H — ENGINE STAY CABLE

J — CABLE HOUSING CLAMP
K — REAR MOUNTING BRACKET
L — REAR MOUNTING SUPPORT CUSHION
M — OPERATING LEVER
N — HAND BRAKE ROD END YOKE
P — CLUTCH CONTROL LEVER
Q — BRAKE PEDAL RETRACTING SPRING
R — CABLE RETRACTING SPRING

RA PD 181535

Figure 36. Disconnect points under vehicle—skid plate removed.

shaft, to the hand brake drum (B). Slide the universal joint back and tie propeller shaft to vehicle frame to prevent damage.

- (10) For vehicles equipped with winch and power-take-off, perform operations (a) through (d) below.
 - (a) Drain the transmission, transfer, and the power-take-off.
 - (b) Remove the winch hanger bearing assembly (par. 171a).
 - (c) Loosen the setscrew (Q, fig. 82) securing the universal joint assembly (M, fig. 82) to the power-take-off output shaft (N, fig. 82) and remove the short drive shaft (L, fig. 82) with universal joints.
 - (d) Remove the five bolts and lock washers holding the power-take-off to the transfer and pull the unit toward the rear of the vehicle to clear the transfer and remove the power-take-off from the vehicle.

g. Remove Power Plant From Vehicle.

- (1) Use a pry bar to move rear of power plant to the right to disconnect the clutch control lever (P, fig. 36) from the ball stud located on transfer case.
- (2) Connect a suitable lifting device in the rear lifting hook (fig. 37), and carefully lift power plant until engine front mounting support cushions clear vehicle frame. Continue to lift power plant and, at the same time, roll vehicle back. Place power plant on a suitable stand.

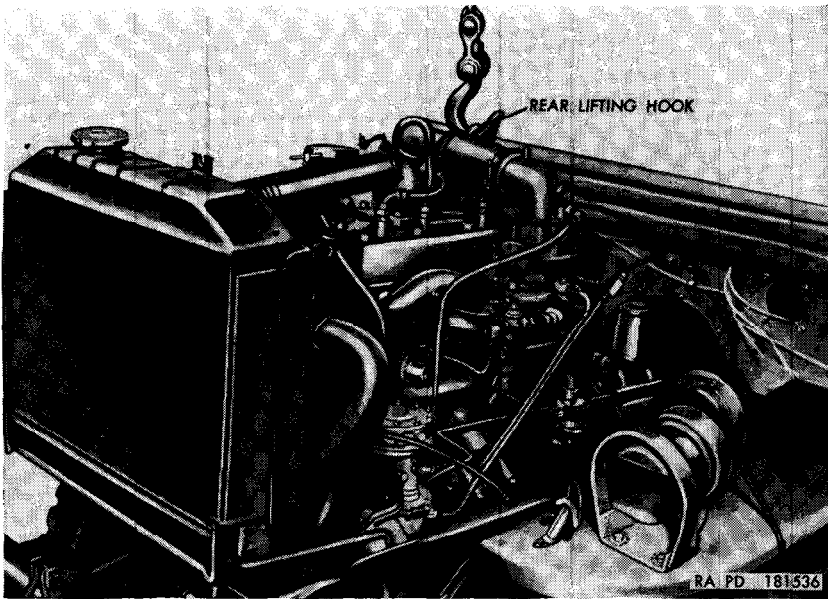

Figure 37. Removing power plant from vehicle.

117. Engine Removal From Power Plant

a. Remove Transmission and Transfer. Drain transmission and transfer. Unscrew the nut securing the transfer case vent line (fig. 31) to the elbow located on transfer case. Remove the four bolts (fig. 31), lockwashers, and flat washers securing the transmission to the clutch bell housing, and remove transmission and transfer. Discard gasket.

b. Remove Radiator. Drain the cooling system (par. 121). Remove radiator hose (par. 125). Lift the radiator off the radiator left and right support rods (figs. 31 and 32).

c. Strengthen Pulley. If inspection of pulley shows that inside flanges are separating at the hub, apply corrective procedure described in (1) through (4) below.

- (1) Remove pulley from engine.
- (2) Lay out three holes in the pulley on a $2\frac{3}{4}$ -inch diameter circle, 30° from centerline of key slot (fig. 38).

Caution: Absolute accuracy of spacing is essential to prevent an unbalanced pulley.
- (3) Drill three $\frac{1}{4}$ -inch holes in pulley.
- (4) Install three $\frac{1}{4} \times \frac{7}{16}$ flat-head steel rivets 118055 and rivet securely in place.

118. Engine Installation in Power Plant

a. Install Radiator. Position radiator on radiator left and right support rods. Install radiator hose (par. 125).

b. Install Transmission and Transfer. Using a new gasket between the transmission and clutch bell housing, install transmission on the bell housing, guiding spline of the transmission main gear shaft into the splines of the clutch assembly. Secure the transmission to the bell housing with four $1\frac{5}{32}$ -inch flat washers, $\frac{7}{16}$ -inch lockwashers, and $\frac{7}{16} \times 1\frac{1}{4}$ bolts (fig. 31).

119. Power Plant Installation

a. Install Power Plant in Vehicle.

- (1) Connect a suitable lifting device to the rear lifting hook (fig. 37) and raise power plant until it clears front of vehicle.
- (2) Lower power plant into engine compartment, tilting down transfer end of power plant.
- (3) Use a pry bar to move power plant to left side of vehicle, and enter clutch control lever (P, fig. 36) on ball stud located on transfer case. Install radiator cushions (fig. 41) on radiator hold-down studs. Aline studs with holes in cross member and aline studs on front mounting support cushions with holes in vehicle frame. Lower front of power plant into position in engine compartment.

b. Operations Under Vehicle.

Note. The key letters noted in parentheses are in figure 36, except where otherwise indicated.

- (1) Untie rear propeller shaft from vehicle frame and position universal joint (A) on handbrake drum (B). Secure in position with four $\frac{3}{8}$ -inch lockwashers and nuts.
- (2) Screw speedometer cable (E) to the speedometer driven gear sleeve.

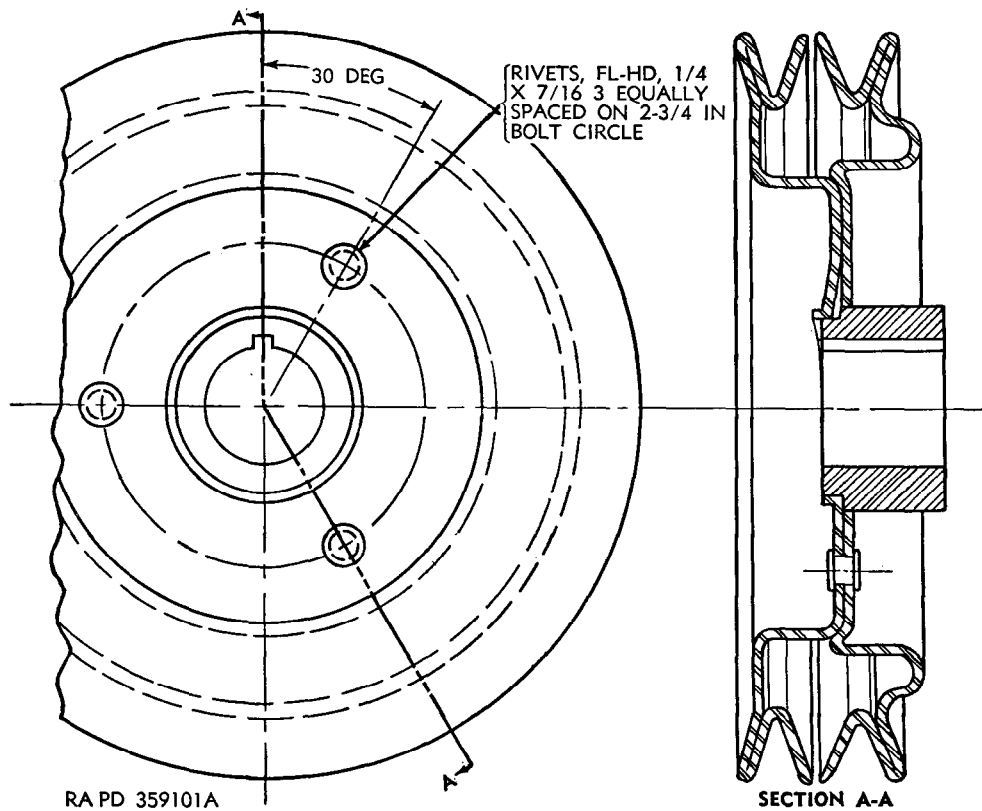

Figure 38. Installation of rivets in pulley.

- (3) Untie handbrake cable from the vehicle frame and position handbrake rod end yoke (N) on operating lever (M). Screw in position with a $\frac{5}{16}$ x 1 clevis pin and $\frac{3}{32}$ x 1 cotter pin.
- (4) Position the cable housing clamp (J) on the rear mounting bracket (K) and secure in position with a $\frac{5}{16}$ x $\frac{7}{8}$ bolt and $\frac{5}{16}$ -inch plain nut inserting bolt through rear mounting bracket (K).
- (5) Position the handbrake cable in the clip mounted on the clutch bell housing and close clip with a pair of pliers.
- (6) Hook the cable retracting spring (R) to the extension located on the operating lever (M) and to the hook secured to the bracket welded to floor panel.
- (7) Install the engine rear support cross member (F) and secure in position with four $\frac{3}{8}$ x $\frac{7}{8}$ bolts, $1\frac{3}{32}$ -inch flat washers, $\frac{3}{8}$ -inch lockwashers, and $\frac{3}{8}$ -inch plain nuts.
- (8) Install two $\frac{3}{8}$ -inch self-locking nuts on the studs on rear mounting support cushion (L) securing the cushion to the engine rear support cross member (F).
- (9) Insert the ball end of the engine stay cable (H) in the bracket (G) located on the engine rear support cross member (F).
- (10) Position skid plate on engine rear support cross member (F) and secure with four $\frac{3}{8}$ x $\frac{7}{8}$ carriage bolts, $1\frac{3}{32}$ -inch plain washers, $\frac{3}{8}$ -inch lockwashers, and $\frac{3}{8}$ -inch plain nuts.
- (11) For vehicles equipped with winch and power-take-off, perform operations (a) through (d) below.
 - (a) Use a new gasket between the power-take-off and the transfer and position the power-take-off on the rear of the transfer. Place $\frac{3}{8}$ -inch lockwashers over the $\frac{3}{8}$ x 1 bolts and push the bolts through the case of the power-take-off and screw into the transfer.
 - (b) Install the short drive shaft (L, fig. 82) with universal joints (par. 169b(4)).
 - (c) Install the hanger bearing assembly (par. 169b(1), (2), and (3)).
 - (d) Tighten the setscrew (Q, fig. 82) securing the universal joint assembly (M, fig. 82) to the power-take-off output shaft (N, fig. 82).
- (12) For vehicles equipped with winch and power-take-off, perform operations (a), (b), and (c) below.

- (a) Install the power-take-off gearshift control lever (HH, fig. 7) with the shift lever plate in the power-take-off and install four No. 10 x $\frac{3}{8}$ screws in the plate.
- (b) Slide the grommet (LL, fig. 7) over the gearshift control lever. Slide the grommet (MM, fig. 7) over the control lever and the grommet (LL, fig. 7). Slide the grommet retaining plate (NN, fig. 7) over the control lever and screw the four No. 10 x $\frac{5}{8}$ screws through the plate and into the floor pan. Screw the knob onto the control lever.
- (c) Fill the power-take-off with correct grade of lubricant (par. 66).

c. Operations Inside Passenger Compartment.

Note. The key letters noted in parentheses are in figure 35, except where otherwise indicated.

- (1) Hook the brake pedal retracting spring (Q, fig. 36) at bracket welded to engine rear support cross member and at brake pedal shank.
- (2) Position the control lever tube cable adjustable yoke (fig. 32) on control lever tube and secure in position with $\frac{5}{16}$ x $2\frac{7}{32}$ clevis pin and $\frac{3}{32}$ x 1 cotter pin.
- (3) Position the case support insulator retaining cup and case support insulator snubber (C, fig. 36) between the transfer and engine rear support cross member. Position the case support insulator underneath the engine rear support cross member and install a $2\frac{1}{32}$ -inch plain washer and $\frac{1}{2}$ x 3 bolt. Secure the snubber in position with $\frac{1}{2}$ -inch flat washer and plain nut.
- (4) Untie the front propeller shaft from vehicle and connect the universal joint at rear of propeller shaft (par. 209).
- (5) Install the upper and lower front floor pan covers (H and N) and secure in position with twenty-four $\frac{1}{4}$ x $\frac{1}{2}$ lockwasher bolts. Install the draft pad and the draft pad spring beneath the upper front floor pan cover. Push the brake pad assembly through the draft pad and the spring into the brake pedal assembly, and tighten the bolt.
- (6) Position the brake master cylinder inspection cover (T) on the lower front floor pan cover (N) and secure in position with four $\frac{1}{4}$ x $\frac{1}{2}$ lockwasher bolts.
- (7) Slide the steering gear jacket access plate seal (D) down the steering gear jacket and into position on the upper front floor pan cover (H). Install the steering gear jacket access plate (E) over the seal and secure in position with four $\frac{1}{4}$ x $\frac{1}{2}$ lockwasher bolts.

- (8) Position the high and low range gearshift lever (J) in transfer output shaft front bearing cap, being sure lower end of lever is in the slot of the shifter shaft. Position the front wheel drive gearshift lever (P) in the cap, being sure the lower end of the lever is in the slot of the shifter shaft. Install a $\frac{5}{8}$ -inch lockwasher on the gearshift lever pivot pin and reach through the opening of the transfer case bolt access plate (M) and insert the pin through the right side of the cap and both shift levers and screw pin loosely into cap. Install one gearshift lever spring on the left side of the transfer high and low range gearshift lever (J), with the tangs of the spring facing to the right of the vehicle, and seat spring on gearshift lever pivot pin. Install the second gearshift lever spring between the high and low range gearshift lever and the front wheel drive gearshift lever (P), with the tangs of the spring facing to the right of the vehicle, and seat spring on gearshift lever pivot pin. Tighten the pivot pin.
- (9) Install the transfer case bolt access plate (M) on the lower front floor pan cover (N) and secure in position with two $\frac{1}{4}$ x $\frac{1}{2}$ lockwasher bolts.
- (10) Position the gearshift lever (A) in the transmission and secure with gearshift lever housing cap. Slide the transmission gearshift lever boot (R) down into position and tighten the two hose clamps (Q and S). Slide the transmission cover (G) over the shift lever and secure in position with seven lockwasher bolts. Install the accelerator foot rest (F) in the upper left corner of the transmission cover (G). Install the three gearshift lever knobs.
- (11) Slide the transfer gearshift levers-to-floor board boot (K) down into position. Slide the shift lever housing cover boot ring (L) over the shift levers and secure in position with four No. 10 x $\frac{1}{2}$ sheet metal screws.

Note. If the clearance between the front wheel drive high and low range shift lever (fig. 35) and floor board is insufficient and noise is caused by vibration of lever against the board, proceed as described in (12) below.
- (12) Engage the lever in the high range position (rearward). Mark or scribe cover boot ring (fig. 35) and floor board at location of contact. Remove the ring and rubber grommet and using a file or cutting torch, cut circular notch (approx $\frac{1}{4}$ in.) in the ring and floor board.

d. Operations At Left Side of Vehicle.

Note. The key letters noted in parentheses are in figure 34, except where otherwise indicated.

- (1) Install the two $1\frac{7}{32}$ -inch flat washers, $\frac{5}{16}$ x 1 bolts, $1\frac{1}{32}$ -inch flat washers, and $\frac{5}{16}$ -inch self-locking nuts securing the front mounting support cushion (R) to the vehicle frame.
- (2) Insert the windshield wiper hose (N) over the windshield wiper line (M).
- (3) Connect cable No. 36 (fig. 85) to the oil pressure gage sending unit (L) by inserting cable plug in receptacle and turning plug clockwise.
- (4) Install the accelerator control rod (H) on the accelerator cross shaft (K) and secure in position with a No. 8 flat washer and $\frac{1}{16}$ x $\frac{1}{2}$ cotter pin.
- (5) Untie the throttle control conduit (F) and choke control conduit (G) from the cowl. Make certain that the throttle and choke controls are pushed in on instrument panel and insert the throttle control wire (C) into throttle valve shaft (W) and stop. Tighten set screw in the stop.

Note. Throttle must be fully closed and stop against throttle valve shaft (W) when screw is tightened.

Insert choke control wire (D) in swivel on choke valve shaft and tighten set screw. Position the throttle control conduit in throttle control conduit bracket (E). Position choke control conduit clamp, with the conduit, on throttle control conduit bracket, and secure with a No. 10 x $\frac{3}{4}$ bolt and No. 10 plain nut.

- (6) Untie the crankcase control valve control wire (U) from the cowl. Make certain control button is pushed in on instrument panel and insert wire into the crankcase control valve control wire swivel (Q) and tighten set-screw. Insert the conduit for the control wire into the clip securing the conduit to the support strap, located at the carburetor front mounting stud, and secure conduit in position with a No. 10 x $\frac{1}{2}$ bolt and No. 10 plain nut.
- (7) Position the exhaust pipe flange gasket on the exhaust pipe. Position exhaust pipe (V) on stud in exhaust manifold (B) and secure pipe to manifold with a $\frac{3}{8}$ -inch nut. Install a $\frac{3}{8}$ x $1\frac{1}{2}$ bolt and $\frac{3}{8}$ -inch nut on other end of flange. Tighten nuts evenly to prevent distortion of the gasket.

- (8) Screw the nut on the fuel line into the fitting on flexible fuel line (S) and tighten the nut.
- (9) Position brace rod (A) in the bracket welded to radiator and in hole in vehicle cowl. Secure cowl end of rod with a $\frac{5}{16}$ -inch lockwasher and nut. Position one $\frac{5}{16}$ -inch nut and flat washer on engine side of brace rod bracket and one $\frac{5}{16}$ -inch flat washer, lockwasher, and nut on radiator side of bracket. Tighten nut on radiator side until radiator is rigid in vehicle. Tighten the nut on the engine side of brace rod bracket.

e. Operations at Right Side of Vehicle.

Note. The key letters noted in parentheses are in figure 33, except where otherwise indicated.

- (1) Install the two $1\frac{7}{32}$ -inch flat washers, $\frac{5}{16}$ x 1 bolts, one $1\frac{1}{32}$ -inch flat washer, and $\frac{5}{16}$ -inch self-locking nut securing front mounting support cushion (P) to the vehicle frame. Install the engine front plate-to-frame ground strap (Q) on the remaining support cushion bolt and secure in position with an $1\frac{1}{32}$ -inch flat washer and $\frac{5}{16}$ -inch self-locking nut.
- (2) Install the battery-to-starter cable (fig. 63) and generator regulator cable on the starter switch (U) and secure in position with a $\frac{3}{8}$ -inch lockwasher and nut.
- (3) Position the generator-to-generator regulator cable (R) at generator (S) and generator regulator (V) and tighten cable connectors.
- (4) Connect cable No. 12 to the wiring harness filter receptacle assembly by inserting cable plug in receptacle and installing nut (T).
- (5) Insert air cleaner control valve control wire (N) into swivel and tighten setscrew.
- (6) Connect cable No. 33 (fig. 85) to receptacle on water temperature sending unit (M) by inserting cable plug into receptacle and turning plug clockwise.
- (7) Position the air cleaner assembly (D) in the right support bracket assembly (C) and install two $\frac{9}{32}$ -inch lockwashers and $\frac{1}{4}$ x $\frac{3}{4}$ wing screws. Position air cleaner assembly in left support bracket assembly and tighten the two wing screws.
- (8) Install the air cleaner-to-air intake pipe flexible hose (L) and tighten hose clamps (J).
- (9) Screw the nut on fuel tank vent line (H) into connector (G).

- (10) Screw the nut on the master cylinder vent line (F) into tee (E).
- (11) Screw the nut on the windshield wiper vent line (B) into tee (E) and slide windshield wiper hose (A) over vent line.
- (12) Connect battery-to-battery ground cable to battery "A" located in the engine compartment.

f. Operations at Front of Vehicle.

- (1) Secure radiator to vehicle frame cross member by installing two $1\frac{1}{2}$ -inch flat washers and $\frac{7}{16}$ -inch nuts on radiator holddown studs (fig. 41).
- (2) Install radiator guard (par. 263).

g. Final Operations.

- (1) Open fuel shutoff valve (P, fig. 34) by turning valve handle counterclockwise.
- (2) Tighten engine stay cable (H, fig. 36) adjusting nut, located at engine side of bell housing, until cable is taut.
- (3) Fill cooling system (par. 121).
- (4) Install hood (par. 261).
- (5) Fill crankcase with correct grade of lubricant (par. 68).
- (6) Fill transmission and transfer with correct grade of lubricant (par. 68).
- (7) Start engine and check for fuel, oil, or water leaks.
- (8) Make a record of replacement on DA Form 478.

Section VII. COOLING SYSTEM

120. Description and Data

a. Description.

- (1) *General.* The cooling system (fig. 39) is fully sealed and pressurized. The system consists of a water pump, water pump bypass, fan, drive belts, radiator, thermostat, and connecting hose. Water is drawn down through the radiator to the bottom thence through the water outlet hose to the water pump which forces it through the cylinder block, cylinder head, and the water inlet hose to the top of the radiator. Air, for cooling the water, is drawn through the radiator by the fan. Correct operating temperature is maintained by the thermostat.
- (2) *Radiator* (figs. 31 and 32). The radiator is the cellular-type, with upper and lower tanks. The filler cap has a spring-loaded seal to maintain a pressure of approximately $4\frac{1}{2}$ psi when the engine is running. The cap seal acts as a safety valve by lifting off its seat to relieve excessive pressure.

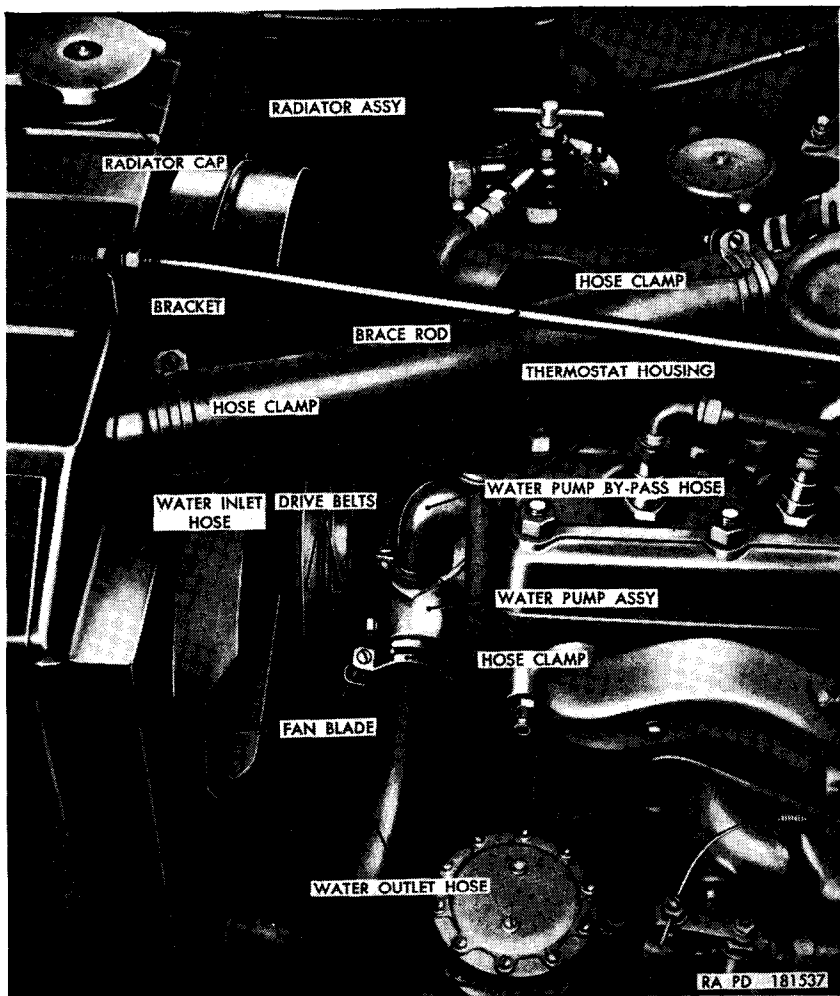

Figure 39. Cooling system.

- (3) *Thermostat.* The thermostat is a bellows-type constructed to maintain an operating temperature of 160° to 180° F. It is located on top of the cylinder head in the thermostat housing (T, fig. 24).
- (4) *Water pump assembly.* The water pump assembly (fig. 39) is the centrifugal-type, located at the front of the cylinder block.
- (5) *Fan.* The fan has four blades and is mounted on the fan and water pump pulley. The water pump and fan are driven by a matched pair of V-belts.

b. Data.

Radiator:

Manufacturer	Blackstone Mfg Co
Type	Cellular
Capacity	11½ qt
Filler cap	4½ psi pressure-type

Water pump and fan:

Water pump type.....	Centrifugal
Fan	Four blade, 15-in diam
Drive	Double V belt
Location	Front of cylinder block

Drive belts:

Type	"V", matched pair
Width	¾-in.
Length	45 7/8-in. outside circumference

Thermostat:

Location	Thermostat housing
Range (opening)	148° to 155° F.

121. Organizational Maintenance

Caution: The cooling system is pressurized. Use care when removing radiator cap.

a. Draining and Filling.

- (1) *Draining.* To drain the cooling system, open the hood and remove the radiator cap slowly to relieve any pressure within the system. If the coolant is to be saved, place a suitable container under the drain cocks (fig. 40) of the radiator and cylinder block. One drain cock is located on the right side of the cylinder block just forward of the starter, and the other is located at the bottom of the radiator on the left side of the water outlet hose fitting. Open both drain cocks, allow cooling system to drain completely, and close drain cocks.
- (2) *Filling.* Be sure that both drain cocks (fig. 40) are closed. Fill the cooling system with water, or antifreeze solution, of sufficient strength to protect the system against the lowest anticipated temperature, to a level approximately 1 inch below the bottom of the filler neck. Run the engine to circulate the coolant and expel air from the system, and recheck the coolant level.

Caution: When adding coolant to the system, be sure that the engine water temperature is below 200° F. before removing the radiator cap.

b. *Cleaning and Flushing.* For directions for cleaning and flushing, refer to TM 9-2858.

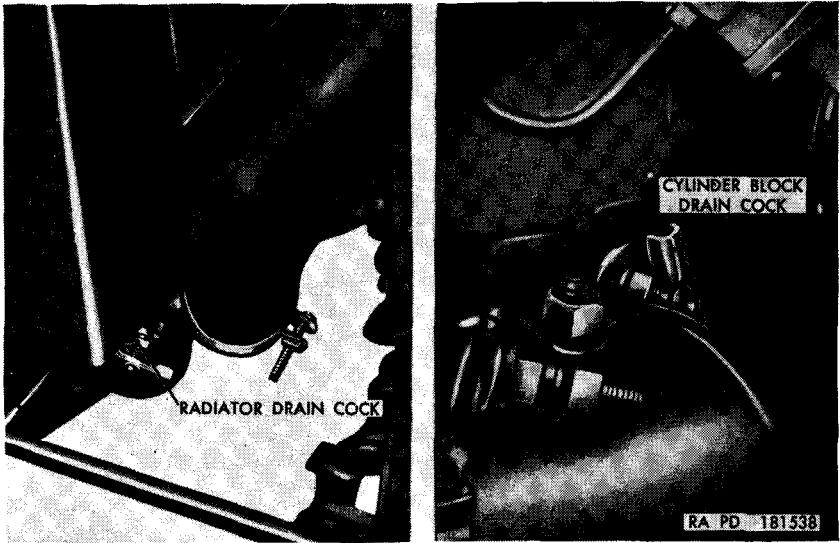

Figure 40. Cooling system drain cocks.

122. Radiator

a. Removal.

- (1) Drain the cooling system (par. 121).
- (2) Remove the radiator guard (par. 263).
- (3) Loosen the nut on the rear end of the brace rod (fig. 39). Loosen the nut on the front end of the brace rod, securing the rod to the bracket, sufficiently to permit the rod to be pulled up out of the bracket. Lift the rod out of the bracket and swing it toward the rear of the vehicle to clear the radiator assembly.
- (4) Loosen the two hose clamp screws on the water inlet hose (fig. 39) and remove hose. Loosen the two hose clamp screws on the water outlet hose (fig. 39) and remove the hose.
- (5) Remove nuts and flat washers from two radiator hold-down studs (fig. 41) holding radiator assembly to frame front cross member.
- (6) Lift radiator assembly straight up, being careful not to rub it against fan. When studs (fig. 41) are clear of frame front cross member, tip radiator forward at the top and remove from vehicle. Remove radiator cushions from studs (fig. 41).

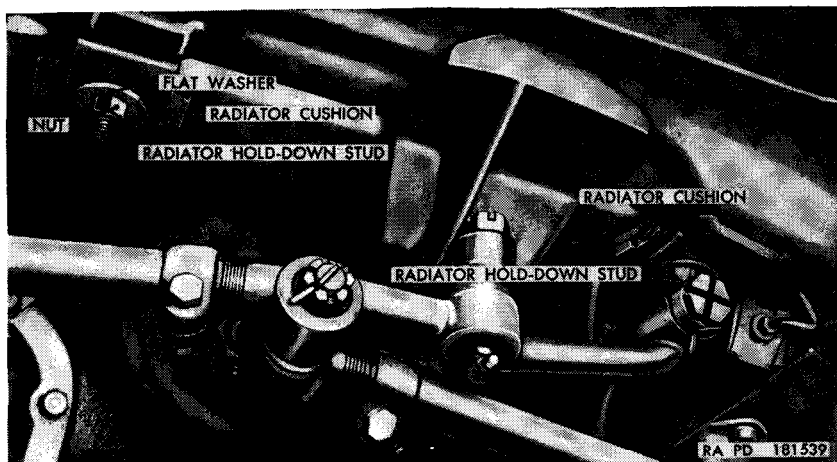

Figure 41. Radiator hold-down studs.

b. Installation.

- (1) Place radiator cushions on radiator hold-down studs (fig. 41). Carefully lower radiator assembly into place, positioning holes in brackets (fig. 32) on radiator over radiator left and right support rods.
- (2) Install two $1\frac{1}{32}$ -inch flat washers and $\frac{7}{16}$ -inch nuts (fig. 41) on studs securing the radiator to the frame front cross member and tighten evenly.
- (3) Install water inlet hose (fig. 39) and tighten both hose clamp screws. Install water outlet hose (fig. 39) and tighten both hose clamp screws.
- (4) Swing the brace rod (fig. 39) toward the front of the vehicle and align rod with slot in bracket on the radiator assembly. Position flat washer against the rear nut at the front end of the rod, position lockwasher and flat washer against the front nut at the front end of the rod. Slide the rod down into the slot. Make sure that one flat washer is at the rear of the bracket and one flat washer at the front. Adjust the rear nut so that the washer is snug against the rear of the bracket. Tighten the nut at the front end of the rod. Fill the cooling system (par. 121) and check for leaks. Install the radiator cap. Start the engine and run until normal operating temperature is reached. Recheck the coolant level.

123. Fan and Generator Drive Belts

a. Adjustment. Loosen the lockwasher screw holding the belt tension adjustment brace to the drive end head of the generator.

Move generator toward or away from the engine, as required, until a firm push on belts will deflect them 1 inch as shown in figure 42. When adjustment is correct, tighten screw holding brace to top of generator. If inspection of pulley shows inside flanges being separated at hub, rivet the pulley as described in paragraph 117.



Figure 42. Adjusting drive belts.

b. Removal. Loosen lockwasher screw holding belt tension adjustment brace to drive end head of the generator and push generator toward engine as far as possible. Remove forward drive belt by working it over forward edge of generator drive pulley, off fan and generator drive pulley, over fan blade, and off fan and water pump pulley. Remove rear drive belt by first working it into forward groove in generator drive pulley, fan and generator drive pulley, and fan and water pump pulley. When belt is in forward groove of each pulley, follow procedure used to remove forward belt.

c. Installation. Place belt over fan, into forward groove of fan and water pump pulley, into forward groove of fan and generator drive pulley, and into forward groove of generator drive pulley. Start at generator drive pulley and work belt into rear groove of each pulley. Install the second belt in the forward grooves. When the belts are in place, adjust as directed in *a* above.

124. Water Pump Assembly, Fan Blade, and Fan and Water Pump Pulley

a. Removal.

- (1) Drain the cooling system (par. 121).
- (2) Remove the fan and generator drive belts (par. 123*b*).
- (3) Remove the water outlet hose (par. 122*a*(4)).
- (4) Loosen the hose clamp screws securing the water pump bypass hose (fig. 39) to the water pump assembly and cylinder head and remove the hose.
- (5) Remove four lockwasher bolts (fig. 42) securing the fan blade to the fan and water pump pulley and remove the fan blade.
- (6) Remove four bolts and lockwashers securing the water pump (fig. 39) to the cylinder block and remove the pump and gasket.
- (7) Clamp the water pump in a vise with soft jaws. Install a water pump pulley puller 41-P-2908-240 (fig. 43) on water pump pulley. Hold puller with wrench and turn puller screw to remove pulley.

b. Installation.

- (1) *Fan and water pump pulley.* Place fan and water pump pulley (fig. 42) on end of water pump shaft and press onto shaft until front face of pulley hub is flush with end of shaft.
- (2) *Water pump assembly.*
 - (a) Make sure that gasket surfaces are clean. Place a new gasket on water pump body, with bolt holes in gasket alined with bolt holes in water pump body.
 - (b) Position pump in opening in front of cylinder block, at the same time, sliding water pump bypass hose (fig. 39), with clamps in place, over connections on water pump and cylinder head.
 - (c) Insert one $\frac{5}{16}$ x $2\frac{1}{2}$ bolt, with lockwasher, through hole in water pump body, adjacent to pump inlet. Start threads, but do not tighten. Insert three $\frac{5}{16}$ x $\frac{7}{8}$ bolts and lockwashers through holes in pump. Start all threads, and tighten all bolts evenly.

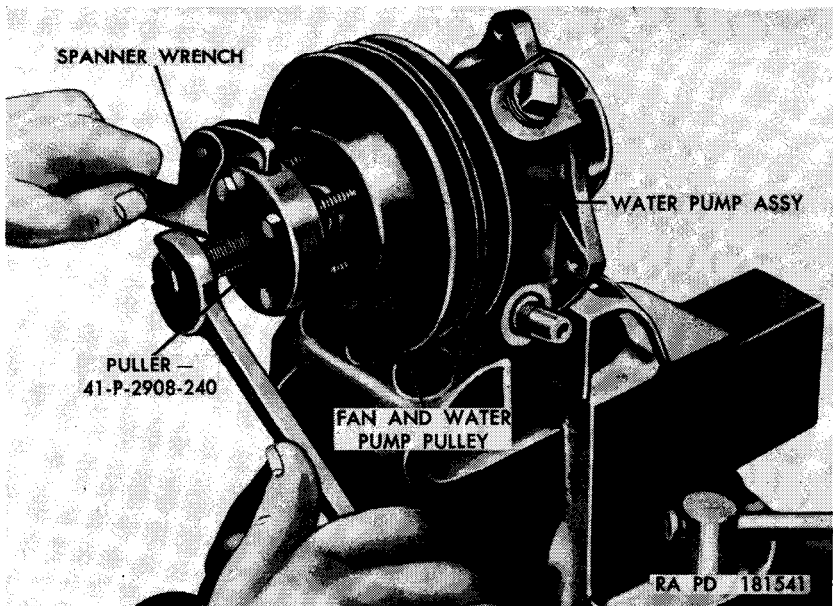

Figure 43. Removing fan and water pump pulley.

- (d) Tighten hose clamps securing the water pump bypass hose (fig. 39) to the water pump and the cylinder head.
- (e) Install the water outlet hose (fig. 39), with hose clamps, on the radiator outlet and the water pump connections, and tighten the hose clamp screws securing the hose.
- (f) Put the fan in place on the front of the fan and water pump pulley with concave side of blades toward the engine and secure in place with four $\frac{1}{4}$ x $\frac{5}{8}$ lock-washer bolts (fig. 42).
- (g) Install and adjust fan and generator drive belts (par. 123).
- (h) Fill cooling system (par. 121). Check all hose connections for water leaks.

125. Radiator and Water Pump Bypass Hose (fig. 39)

a. Water Outlet Hose.

- (1) *Removal.* Drain cooling system (par. 121). Loosen hose clamp screws securing the water outlet hose to radiator and water pump assembly and remove hose. Remove hose clamps if necessary.

- (2) *Installation.* Make sure that connections are clean and free from rust or scale. Place hose clamps over ends of hose. Make sure that reinforcement is in place inside the hose. Place lower end of water outlet hose over connection on radiator. Place upper end of hose over connection on water pump. Tighten hose clamp screws securing the hose to the connections. Fill cooling system (par. 121) and check all connections for leaks.

b. Water Inlet Hose.

- (1) *Removal.* Drain cooling system (par. 121). Loosen hose clamp screws securing the water inlet hose to radiator connection and thermostat housing, and remove hose by pulling from radiator and thermostat housing. Remove hose clamps if necessary.
- (2) *Installation.* Make sure that connections at radiator and thermostat housing are clean and free from rust or scale. Place hose clamps over ends of hose. Place hose over connections on thermostat housing and radiator. Tighten hose clamp screws securing the hose to the connections. Fill cooling system (par. 121) and check all connections for leaks.

c. Water Pump Bypass Hose.

- (1) *Removal.* Drain cooling system (par. 121). Loosen hose clamp screws at both ends of the water pump bypass hose. Remove end of hose from cylinder head, and remove other end from water pump. Remove hose clamps if necessary.
- (2) *Installation.* Make sure connections are clean and free from rust or scale. Place hose clamps over ends of hose. Place hose on water pump and cylinder head connections and tighten hose clamp screws securing hose to connection. Fill cooling system (par. 121) and check all connections for leaks.

126. Thermostat

a. Removal. Drain cooling system (par. 121). Remove three screws and lockwashers holding thermostat housing (fig. 39) to cylinder head. Loosen hose clamp screw on radiator end of water inlet hose (fig. 39). Lift thermostat housing from cylinder head, being careful not to damage thermostat, and pull inlet hose from radiator. Use pliers to remove thermostat retainer from housing and remove thermostat. Discard gasket.

b. Installation. Be sure that gasket surfaces on cylinder head and thermostat housing are clean. Be sure that connection on

radiator is clean, and free from rust or scale. Place thermostat in housing and install the retainer holding thermostat in place. If retainer extends beyond the surface of the thermostat housing, remove the retainer and grind until flush with the housing mounting surface to prevent loss of engine coolant. Place a new thermostat housing gasket on cylinder head with screw holes alined. Position hose clamp on radiator end of water inlet hose. Slide hose onto radiator. Carefully insert the projecting end of thermostat into cylinder head and aline the screw holes in the thermostat housing with screw holes in cylinder head being careful not to disturb gasket. Install three $\frac{3}{8}$ x $1\frac{1}{8}$ screws and lockwashers to secure thermostat housing to cylinder head. Tighten screws evenly. Tighten hose clamp screw securing the water inlet hose to radiator. Fill cooling system (par. 121) and check all connections for leaks. Start engine and run until normal operating temperature (par. 120a(3)) is reached. Check operation of thermostat by removing radiator cap and watching water in radiator. Water should start to flow when 160° F. is reached. Check for leaks with engine running.

Section VIII. FUEL AND AIR INTAKE SYSTEM

127. Description and Data

a. Description.

- (1) *General.* Components of the fuel and air intake system include the carburetor assembly, fuel and vacuum pump, air cleaner assembly, accelerator, throttle and choke controls, fuel filter assembly, fuel tank, fuel gage, fuel tank level sending unit assembly, and fuel lines and fittings.
- (2) *Air cleaner assembly* (D, fig. 33). The air cleaner assembly, an oil bath-type with a removable element, is fully sealed for underwater operation. The assembly is mounted at the right rear of the engine compartment and is connected to the carburetor by a hose pipe with vent valve. Air is drawn through the air precleaner with rain deflector assembly and against the oil in the oil cup where most of the dust is deposited. The air then passes through the element and through the connecting pipe to the carburetor.
- (3) *Carburetor assembly* (fig. 32). The carburetor assembly is a waterproof, single-venturi, downdraft balanced-

type, sealed at all control and adjustment points. The float chamber is also fully sealed. The carburetor assembly is mounted over the center of the intake manifold.

- (4) *Fuel and vacuum pump* (fig. 32). The fuel and vacuum pump is the diaphragm-type, providing constant flow of fuel to the carburetor when the engine is running. The vacuum pump is incorporated to assist the windshield wiper motor action. The pump used in early model vehicles was equipped with a hand priming lever for manually pumping fuel to the carburetor.
- (5) *Fuel shutoff valve* (P, fig. 34). The fuel shutoff valve is located at the left of the steering gear assembly. This valve shuts off the fuel supply from the fuel tank to the fuel pump.
- (6) *Fuel tank and cap* (fig. 50). The fuel tank is located on the left side of the vehicle, under the driver's seat. The filler cap is located in a recess in the left side of the body panel. The fuel tank level sending unit assembly is located on top of the fuel tank. The fuel filter assembly is located in the top of the fuel tank. The fuel tank is equipped with a relief pressure valve which will permit pressure to build up in the tank to a maximum of 4 psi. The cap (fig. 5) is a solid-type pressure cap designed for use only with this vehicle and should not be interchanged with the vented-type pressure cap, used with $\frac{3}{4}$ -ton trucks, which open and release excess pressure. The solid-type cap used with truck M38 (fig. 5) has a cup about $3\frac{1}{2}$ inches in diameter, inside of the shell, with a rivet in the center of the cup and a safety chain *riveted* about 1 inch off center. The vented-type filler cap used on the $\frac{3}{4}$ -ton trucks is of a spoke-like design, has a $3\frac{1}{2}$ -inch diameter cup inside the cap with a vent hole approximately $\frac{1}{4}$ -inch in diameter in the center, and a fastener *stamped* out to which a chain clip is attached. The cap used on the truck M38 is marked either embossed letters or decalcomania with the word *pressurized* and instructions to open slowly while the vented-type cap is stamped with the words **PRESSURE CAP**.
- (7) *Lines and fittings* (fig. 52). Fittings and solid and flexible lines connect the various parts of the system. Vent lines from the fuel tank and carburetor are connected directly to the air cleaner assembly.

(8) *Fuel filter assembly* (fig. 50). A fuel filter assembly is installed in the top of the fuel tank. The assembly is removable for cleaning or replacement of the fuel filter element.

b. Data.

Carburetor assembly:

Manufacturer	-----	Carter Carburetor Corp
Model	-----	YS637S
Type	-----	Downdraft
Venturi	-----	Single
Adjustments	-----	Mixture and speed

Fuel and vacuum pump:

Manufacturer	-----	AC Spark Plug Div, GMC
Model	-----	1539585
Type	-----	Diaphragm
Drive	-----	Camshaft
Pressure	-----	4 to 5¼ psi at 1,800 rpm
Vacuum	-----	10 in. at 200 rpm, 12 in. at 1,500 rpm

Air cleaner assembly:

Manufacturer	-----	Houdaille-Hershey Corp, Oakes Products Div
Model	-----	OKS-X-615980
Type	-----	Oil bath
Capacity (oil)	-----	1¼ pt

Fuel tank:

Capacity	-----	13 gal
Type	-----	Pressurized
Filler cap location	-----	Left side

128. Organizational Maintenance

Adjustment of the idle mixture and idle speed, or replacement of the carburetor assembly, are organizational maintenance operations. Repair or overhaul of the carburetor assembly is performed by the supporting ordnance maintenance unit.

129. Carburetor Assembly

Note. The key letters noted in parentheses are in figure 44, except where otherwise indicated.

a. Adjustments. Adjustment screws are provided to adjust the idle air-fuel mixture and the idle speed. Make both adjustments with the engine running at normal operating temperature (160° to 180° F.), and an idle speed of approximately 600 rpm. Adjust the air-fuel mixture by turning the idle adjusting screw (F) clockwise or counterclockwise until the engine idles smoothly and evenly.

Note. Do not jam the idle adjusting screw against the seat in the carburetor assembly as the seat and the idle adjusting screw threads are easily damaged. If damage to screw occurs, replace screw before making adjustment. If the seat is damaged, replace the carburetor assembly.

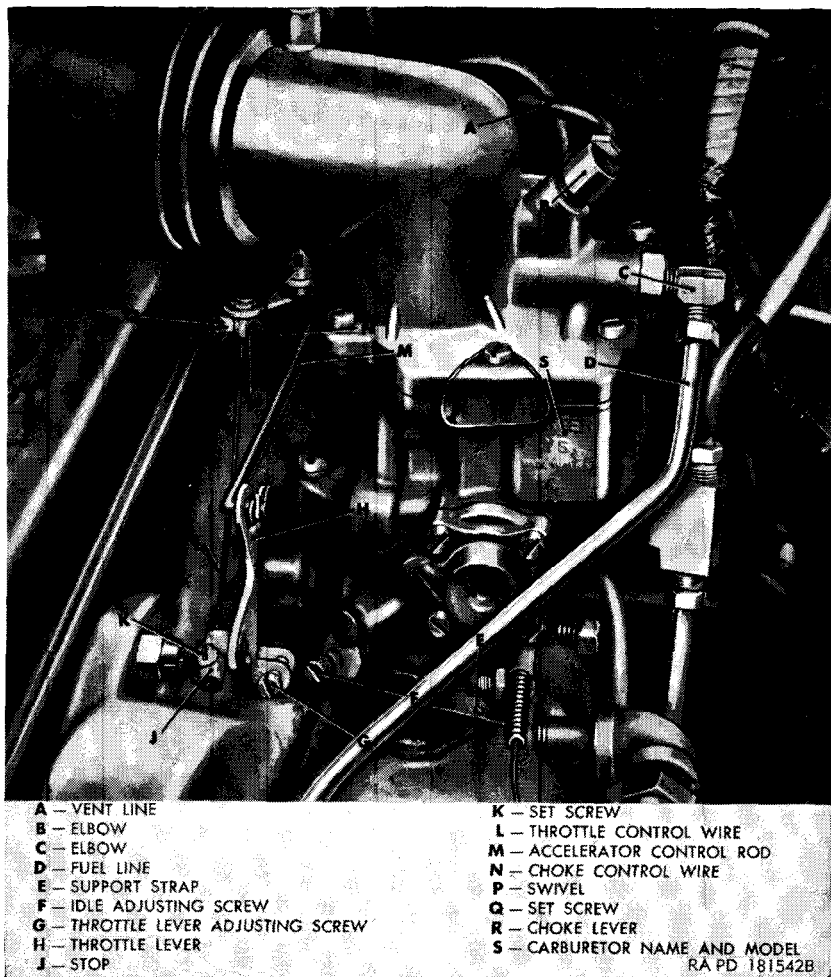

Figure 44: Carburetor removal or installation—front view.

To adjust the idle speed, turn the throttle lever adjusting screw (G) clockwise to increase the speed and counterclockwise to decrease the speed of the engine.

b. Removal.

- (1) Loosen the setscrew (K) securing the throttle control wire (L) to the stop (J) and remove the stop from the throttle control wire.
- (2) Loosen the setscrew (Q) securing the choke control wire (N) to the swivel (P).
- (3) Remove the cotter pin and flat washer from the accelerator control rod (M) and slide the rod out of the hole in the throttle lever (H).

- (4) Disconnect the vent line (A) from the elbow (B) on the carburetor and unscrew the elbow from the carburetor.
- (5) Disconnect the fuel line (D) from the elbow (C) on the carburetor and unscrew the elbow from the carburetor.
- (6) Remove the nut securing the support strap (E) and the carburetor assembly to the intake manifold and remove the strap from the manifold stud.
- (7) Loosen the hose clamp screw (fig. 45) securing the moulded hose to the carburetor.

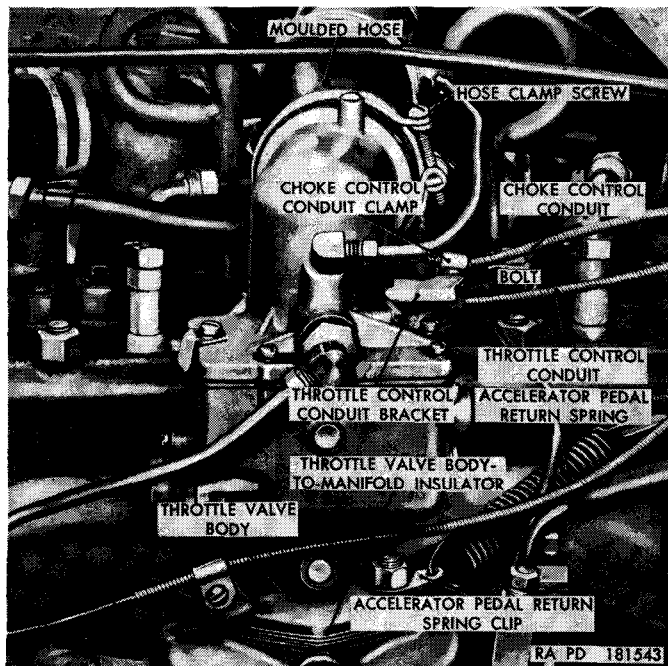

Figure 45. Carburetor removal or installation—left side.

- (8) Remove the plain nut and bolt securing the choke control conduit (fig. 45) and clamp to the throttle control conduit bracket and slide the choke control wire (N) out of the swivel (P).
- (9) Spread the opening in the throttle control conduit bracket (fig. 45) sufficiently to pull the throttle control conduit out of the bracket and the throttle control wire (L) out of the swivel of the throttle lever.
- (10) Unhook the accelerator pedal return spring from the accelerator pedal return spring clip (fig. 45).

- (11) Remove the nut securing the accelerator pedal return spring clip and the carburetor to the manifold stud and remove the clip from the stud. Lift the carburetor off the studs and remove from the vehicle. Remove the old throttle valve body-to-insulator gasket and the throttle valve body-to-manifold insulator (fig. 45) from the manifold studs.

c. Installation.

- (1) Place a new throttle valve body-to-manifold insulator (fig. 45) and a new throttle valve body-to-insulator gasket over the studs in the manifold. Place the carburetor over the studs and into the moulded hose.
- (2) Place the support strap (E) over the front manifold stud and screw nut onto stud fingertight. Place the accelerator pedal return spring clip (fig. 45) over the intake manifold stud and screw the nut on the stud fingertight. Tighten the front and rear nuts on the manifold studs evenly. Hook the accelerator pedal return spring into the clip.
- (3) Slide the throttle control wire (L) through the throttle control conduit bracket (fig. 45) and through the swivel on the throttle lever (H). Make sure that the throttle control (BB, fig. 7) is pushed all the way into the instrument panel. Place the stop (J) over the end of the throttle control wire (L) and push it up to the swivel on the throttle lever (H). Tighten the setscrew (K).
- (4) Slide the choke control wire (N) through the swivel (P). Make sure that the choke control (CC, fig. 7) is pushed all the way into the instrument panel. Push the choke lever (R) toward the front of the vehicle as far as it will go and tighten the setscrew (Q). Position the choke control conduit clamp (fig. 45) on the throttle control conduit bracket. Put the No. 10 x $\frac{3}{4}$ bolt through the throttle control conduit bracket and the choke control conduit clamp. Screw No. 10 plain nut on the bolt and tighten with a screwdriver.
- (5) Tighten the hose clamp screw (fig. 45) securing the moulded hose to the carburetor.
- (6) Push the end of the accelerator control rod (M) through the hole in the throttle lever (H). Place a flat washer over the end of the rod and install a cotter pin.
- (7) Screw the elbow (C) into the carburetor and connect the fuel line (D) to the elbow. Screw the elbow (B) into the carburetor and vent line (A) into the elbow.

- (8) Start the engine and warm up to operating temperature. Check the controls for proper operation. Check for smooth, even operation of the engine or air leaks around the throttle valve flange insulator.

d. Throttle Valve Body-To-Manifold Insulator and Throttle Valve Body-To-Insulator Gasket.

(1) *Removal.*

- (a) Disconnect the fuel line (D), between the fuel and vacuum pump and the carburetor, by unscrewing the nut at the carburetor end of the line. Disconnect the vent line (A), between the air intake pipe and the carburetor, by unscrewing the nut at the carburetor end of the line.
- (b) Unhook the accelerator pedal return spring from the accelerator pedal return spring clip. Remove the nut and accelerator pedal return spring clip (fig. 45) from the manifold stud at the rear of the carburetor. Remove the nut and support strap (E) from the manifold stud at the front of the carburetor.
- (c) Loosen the hose clamp screw (fig. 45) securing the moulded hose to the carburetor and slide the hose from the carburetor. Raise the carburetor until it clears the studs in the intake manifold. Remove and discard the throttle valve body-to-manifold insulator and throttle valve body-to-insulator gasket and clean the contact surfaces on the intake manifold and the throttle valve flange.

(2) *Installation.*

- (a) Install new throttle valve body-to-manifold insulator and throttle valve body-to-insulator gasket over the intake manifold studs and place the carburetor over the studs.
- (b) Place the support strap (E) over the front stud and screw a nut on the stud fingertight. Place the accelerator pedal return spring clip over the rear stud and screw a nut on the stud fingertight. Tighten the front and rear stud nuts evenly securing the clip, support strap, and carburetor to the intake manifold. Hook the accelerator pedal return spring into the clip.
- (c) Connect the vent line (A) to the carburetor by screwing the nut at the carburetor end of the line into the fitting on the carburetor. Connect the fuel line (D)

end of the line into the fitting on the carburetor. Slide the moulded hose onto the carburetor and tighten the hose clamp screw securing the hose to the carburetor.

130. Accelerator, Choke, and Throttle Controls

Note. The key letters noted in parentheses are in figure 46, except where otherwise indicated.

a. Accelerator Pedal Assembly.

- (1) *Accelerator pedal adjustment.* The accelerator pedal adjustment is made through the threaded accelerator control rod adjusting block (M) of the threaded accelerator control rod with block and spring clip assembly (P).
 - (a) Unhook the accelerator pedal return spring (R) from the accelerator pedal return spring clip (S).
 - (b) Remove the cotter pin and flat washer from the accelerator control rod adjusting block (M) and separate the block from the accelerator cross shaft with lever and bracket assembly (T).
 - (c) Loosen the nut on the accelerator control rod and screw the adjusting block forward or backward on the rod until the desired position is attained. When the block is properly adjusted, and the accelerator pedal (FF) is depressed all the way, the top end of the throttle valve shaft lever (Q) is as far back as it will travel toward the rear of the vehicle. When the block is properly adjusted, tighten the locknut (N) on the accelerator control rod. Connect the accelerator control rod adjusting block (M) to the accelerator cross shaft, install a No. 8 flat washer on the adjusting block, insert $\frac{1}{16} \times \frac{1}{2}$ cotter pin, and spread the pin.
- (2) *Removal.*
 - (a) Pull the accelerator pedal assembly (FF) out of the accelerator link boot (X) and the cross shaft lever-to-accelerator pedal link connector (Y).
 - (b) Remove the cotter pin from the accelerator pedal hinge pin (DD) and remove the pin, accelerator pedal hinge spring, and pedal from the accelerator pedal-to-floor board hinge (EE).
- (3) *Installation.*
 - (a) Position the accelerator pedal assembly (FF) in the accelerator pedal-to-floor board hinge (EE). Position the accelerator pedal hinge spring between the pedal and the hinge. Push the accelerator hinge pin (DD) through the hinge, over the top of the spring, through

- A** - BOLT
B - HAND THROTTLE CONTROL WIRE STOP WITH BOLT ASSY
C - PIVOT
D - SCREW
E - CHOKE VALVE SHAFT LEVER
F - CHOKE CONTROL CONDUIT CLAMP
G - GROMMET
H - THROTTLE CONTROL ASSY
J - LOCKWASHER NUT
K - LOCKWASHER NUT
L - CHOKE CONTROL ASSY
M - ACCELERATOR CONTROL ROD ADJUSTING BLOCK
N - LOCK NUT
P - ACCELERATOR CONTROL ROD WITH BLOCK AND SPRING CLIP ASSY
Q - THROTTLE VALVE SHAFT LEVER
R - ACCELERATOR PEDAL RETURN SPRING
S - ACCELERATOR PEDAL RETURN SPRING CLIP
T - ACCELERATOR CROSS SHAFT WITH LEVER AND BRACKET ASSY
U - LOCK WASHER
V - BOLT
W - LINK
X - ACCELERATOR LINK BOOT
Y - ACCELERATOR CROSS SHAFT LEVER-TO-ACCELERATOR PEDAL LINK CONNECTOR
Z - NUT
AA - LOCK WASHER
BB - BOLT
CC - NUT
DD - ACCELERATOR HINGE PIN
EE - ACCELERATOR PEDAL-TO-FLOOR BOARD HINGE
FF - ACCELERATOR PEDAL ASSY

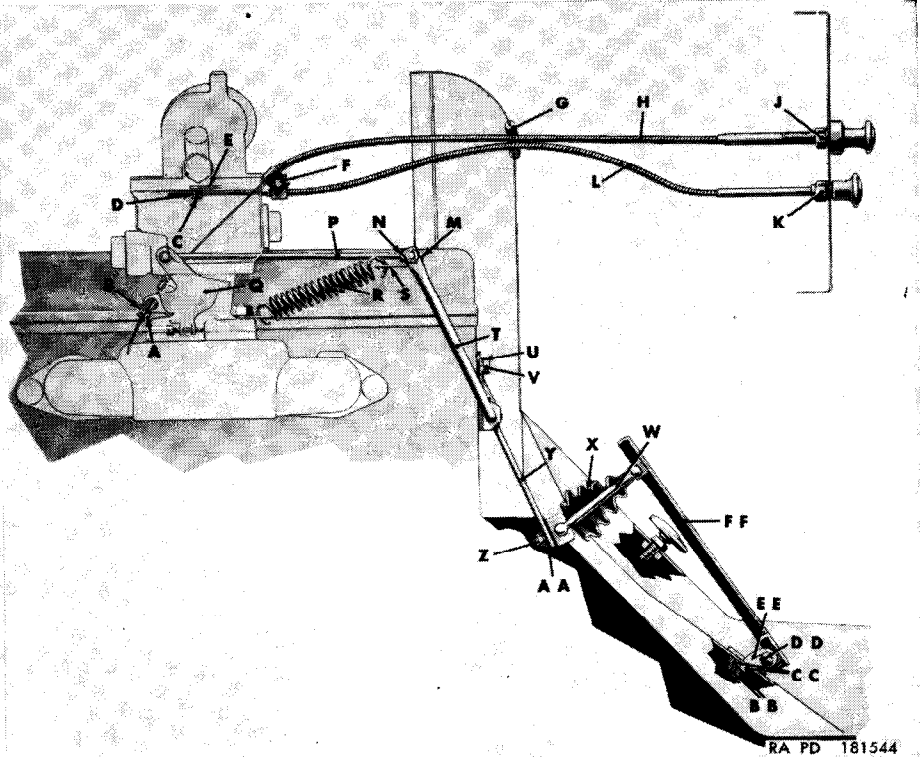

RA PD 181544

Figure 46. Accelerator, choke, and throttle controls.

the hinge, over the top of the spring, through the pedal, and install a $\frac{1}{16}$ x $\frac{1}{2}$ cotter pin in the hinge pin.

- (b) Push the link (W) of the pedal through the accelerator link boot (X) and into the cross shaft lever-to-accelerator pedal link connector (Y).

b. Accelerator Pedal-To-Floor Board Hinge.

(1) *Removal.*

- (a) Remove the accelerator pedal assembly (a(2) above).
- (b) Unscrew the two bolts (BB) from the nuts (CC) and remove the accelerator pedal-to-floor board hinge (EE).

(2) *Installation.*

- (a) Position the accelerator pedal-to-floor board hinge (EE) on the floor board. Install two No. 10 x $\frac{1}{2}$ bolts (BB) through the hinge and the floor board and install the No. 10 nuts (CC) on the bolts.
- (b) Install the accelerator pedal assembly (a(3) above).

c. Accelerator Pedal Hinge Spring.

- (1) *Removal.* Remove the accelerator pedal assembly (a(2) above) and remove the spring.

- (2) *Installation.* Install the spring and the accelerator pedal assembly (a(3) above).

d. Accelerator Cross Shaft With Lever and Bracket Assembly.

(1) *Removal.*

- (a) Remove the upper front floor plan cover, (H, fig. 35) (par. 116e(5)-(7)).
- (b) Unhook the accelerator pedal return spring (R) from the accelerator pedal return spring clip (S).
- (c) Pull the link (W) of the accelerator pedal assembly (FF) out of the cross shaft lever-to-accelerator pedal link connector (Y).
- (d) Remove the cotter pin and flat washer from the accelerator control rod adjusting block (M) and remove the block from the accelerator cross shaft with lever and bracket assembly (T).
- (e) Unscrew the two bolts (V) from the bracket of the cross shaft and remove the bolt and lock washers (U). Remove the cross shaft from the vehicle.

(2) *Installation.*

- (a) Position the bracket of the accelerator cross shaft with lever and bracket assembly (T) on the rear of the engine. Place a $\frac{1}{4}$ -inch lockwasher on the two $\frac{1}{4}$ x $\frac{9}{16}$ bolts, push the bolts through the bracket, and screw into the engine.

- (b) Position the accelerator control rod adjusting block (M) in the cross shaft with lever and bracket assembly (T) and install a No. 8 flat washer and a $\frac{1}{16} \times \frac{1}{2}$ cotter pin. Hook the accelerator pedal return spring (R) into the accelerator pedal return spring clip (S).
- (c) Install the upper front floor pan cover (H, fig. 35) par. 119c(5), (6), and (7)).

e. Accelerator Control Rod With Block and Spring Clip Assembly.

(1) *Removal.*

- (a) Unhook the accelerator pedal return spring (d(1) (a) above).
- (b) Disconnect the accelerator control rod adjusting block (d(1) (c) above).
- (c) Remove the cotter pin and flat washer from the rod of the accelerator control rod with block and spring clip assembly (P) and remove the rod from the throttle shaft lever (Q).

(2) *Installation.*

- (a) Install the rod of the accelerator control rod with block and spring clip assembly (P) into the throttle valve shaft lever (Q) and install a No. 8 flat washer and a $\frac{1}{16} \times \frac{1}{2}$ cotter pin in the rod.
- (b) Install the accelerator control rod adjusting block (d(2) (b) above).

f. Accelerator Control Rod Adjusting Block.

(1) *Removal.*

- (a) Remove the block from the accelerator cross shaft with lever and bracket assembly (d(1) (a) and (c) above).
- (b) Loosen the lock nut (N) and unscrew the block (M) from the rod.

(2) *Installation.* Screw the accelerator control rod adjusting block (M) on the control rod.

(3) *Adjustment.* Adjust the block (a(3) above).

g. Cross Shaft Lever-To-Accelerator Pedal Link Connector.

(1) *Removal.*

- (a) Pull the link of the accelerator pedal assembly (FF) out of the cross shaft lever-to-accelerator pedal link connector (Y).
- (b) Unscrew the nut (Z) and remove the lockwasher (AA). Remove the connector (Y) from the lever of the cross shaft with lever and bracket assembly (T).

(2) *Installation.* Push the stud of the cross shaft lever-to-accelerator pedal link connector (Y) through the hole in

the lever of the cross shaft with lever and bracket assembly (T) from the top. Place a No. 10 lockwasher over the stud and install a No. 10 nut.

h. Throttle Control Assembly.

- (1) *Adjustment.* Push the throttle control (BB, fig. 7) all the way into the instrument panel. Loosen the bolt (A) in the hand throttle control wire stop with bolt assembly (B). Slide the stop up to the pivot on the throttle valve shaft lever (Q), slide the stop away from the lever slightly, and tighten the bolt.
- (2) *Removal.*
 - (a) Loosen the bolt (A) in the hand throttle control wire stop with bolt assembly (B) and slide the stop off the wire. Loosen the bolt and nut in the choke control conduit clamp (F).
 - (b) Unscrew the lockwasher nut (J) from the throttle control assembly on the reverse side of the instrument panel.
 - (c) Pull the throttle control assembly out of the pivot of the throttle valve shaft lever, the clamp (F), the grommet (G) in the dash, the lockwasher nut (J), and the instrument panel.
- (3) *Installation.*
 - (a) Push the end of the throttle control assembly (H) through the hole in the instrument panel part way and slide the $\frac{3}{8}$ -inch lockwasher nut (J) over the end of the control.
 - (b) Push the end of the control through the grommet (G), the choke control conduit clamp (F), and the pivot on the throttle valve shaft lever (Q).
 - (c) Screw the $\frac{3}{8}$ -inch lockwasher nut (J) onto the throttle control assembly on the reverse side of the instrument panel. Leave a little slack in the throttle control assembly between the instrument panel and the choke control conduit clamp (F) and tighten the bolt and nut in the clamp.
 - (d) Slide the hand throttle control wire stop with bolt (B) over the end of the control wire and adjust ((1) above).

i. Choke Control Assembly.

- (1) *Adjustment.* Loosen the screw (D) in the pivot (C) on the choke valve shaft lever (E). Push the choke control assembly (CC, fig. 7) all the way into the instrument panel. Push the lever (E) of the choke valve shaft to-

ward the front of the vehicle as far as it will go. Tighten the screw (D) in the pivot.

(2) *Removal.*

- (a) Loosen the screw (D) in the pivot (C). Loosen the bolt and nut in the choke control conduit clamp (F).
- (b) Unscrew the lockwasher nut (K) from the choke control assembly on the reverse side of the instrument panel.
- (c) Pull the choke control assembly (L) out of the pivot (C), clamp (F), grommet (G), lockwasher nut (K), and instrument panel.

(3) *Installation.*

- (a) Push the end of the choke control assembly (L) through the hole in the instrument panel part way and slide the $\frac{3}{8}$ -inch lockwasher nut (K) over the end of the assembly.
- (b) Push the end of the choke control assembly (L) through the grommet (G), the choke control conduit clamp (F), and the pivot (C).
- (c) Screw the $\frac{3}{8}$ -inch lockwasher nut (K) onto the choke control assembly on the reverse side of the instrument panel. Leave a little slack in the assembly between the instrument panel and the choke control conduit clamp (F) and tighten the bolt and nut in the choke control conduit clamp.
- (d) Adjust the choke control assembly ((1) above).

131. Fuel and Vacuum Pump

(fig. 47)

a. *Removal.*

- (1) Close the shutoff valve (N, fig. 52).
- (2) Disconnect the fuel line to carburetor at the fuel and vacuum pump by unscrewing the nut on the line from the elbow in the pump. Unscrew the elbow from the pump only if necessary. Disconnect the two vacuum lines from the pump by unscrewing the nuts on the lines from the connectors in the pump. Unscrew the two connectors from the pump only if necessary. Disconnect the vent line by unscrewing the nut on the line from the connector in the elbow. Disconnect the flexible fuel line by unscrewing the nut on the line from the fitting on the flexible line. Unscrew the flexible line from the pump only if necessary.

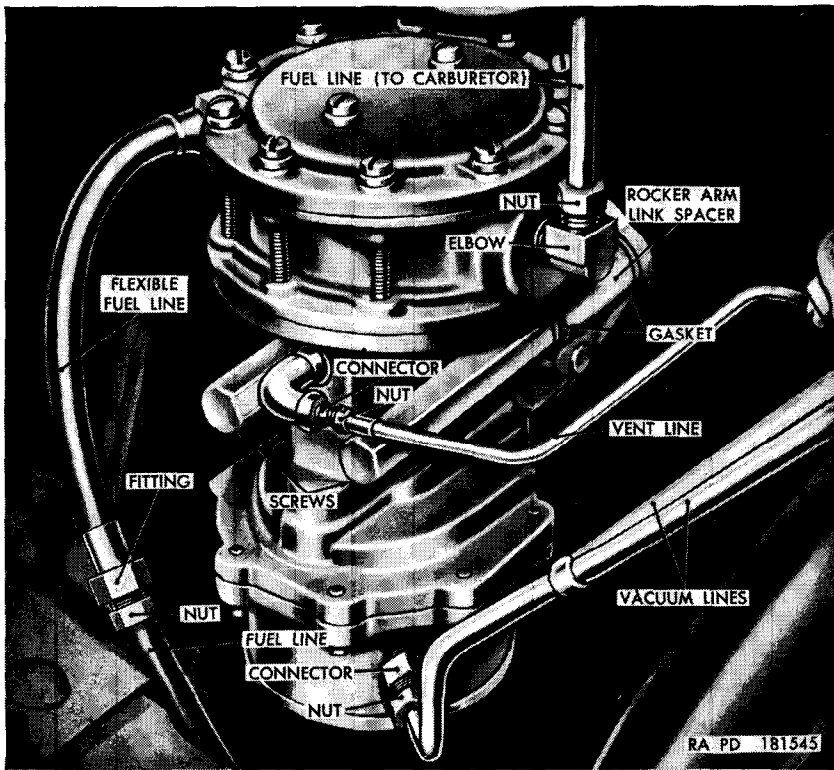

Figure 47. Fuel and vacuum pump—installed.

- (3) Remove the two screws securing the fuel and vacuum pump, rocker arm link spacer, and gaskets to the crankcase and remove the parts.

b. Modification of Fuel Pump (fig. 48). To minimize premature failures of fuel pumps caused by excessive pressures within the fuel pump and the trapped oil in the lower section of the upper body, modify the pump as described in (1) through (8) below.

- (1) Remove machine screws and lockwashers which secure the flanges of the upper and lower section bodies.

Note. Scribe marks on outer edge of flanges for alinement during assembly.

- (2) Remove upper fuel section body, diaphragm with pull rod, spring retainer, and diaphragm spring.
- (3) Using a hook-shaped tool, remove oil seal retainer and oil seal. Exercise care during this operation to prevent damage to oil seal retainer.

Note. If oil seal retainer is staked in place, remove the staking with a small chisel, round file, or grinding wheel before pulling the retainer and oil seal from the pump.

Discard the oil seal but retain the oil seal retainer if fuel pump repair kit G740-7375384 is used. Discard the oil seal and retainer if fuel pump repair kit G758-8329981 is used.

- (4) Drill a $\frac{1}{8}$ -inch hole in deck of body (fig. 48) to act as an oil return and pressure relief hole. Metal clips resulting from the drilling should be blown from the fuel pump with compressed air.
- (5) Install new oil seal and original retainer when using fuel pump repair kit G740-7375384; if fuel pump repair kit G758-8329981 is used, install oil seal retainer G758-8329706.
- (6) Install diaphragm spring and spring retainer.
- (7) Install new diaphragm with pull rod after soaking it in clean kerosene. While holding the diaphragm flange in the upward position, insert the pull rod through the spring retainer, spring, and oil seal retainer in the lower fuel section body. The flat of the pull rod must be at right angles to the fuel link. Hook the pull rod to the short (outer) fuel link.
- (8) Aline the upper fuel section body on the lower fuel section body in accordance with marks scribed in (1) above. Push on rocker arm until diaphragm is flat across body flange. Install original screws and lockwashers until screws just engage lockwashers. Push rocker arm in a full stroke and tighten screws securely.

Note. Diaphragm must be in fixed (down) position while tightening cover screws, or pump will deliver too much pressure.

c. Installation.

- (1) Insert the two $\frac{5}{16} \times 1\frac{7}{8}$ screws in the fuel and vacuum pump from the outside. Place a gasket over the screws. Place the rocker arm link spacer over the screws. Place a second gasket over the screws. Position the pump with spacer and gaskets on the engine. Be sure the rocker arm link is over the top of the cam on the camshaft. Start the screws into the engine and tighten evenly.
- (2) Screw the flexible fuel line into the pump, if removed, and connect the fuel line to the flexible fuel line by screwing the nut on the end of the fuel line into the flexible fuel line. Screw the elbow and connector into the pump, if removed, and connect the vent line to the connector by screwing the nut on the vent line into the connector. Screw the two connectors into the pump, if removed, and connect the two vacuum lines to the pump by screwing

the nuts on the ends of the lines into the connectors on the pump. Screw the elbow into the pump, if removed, and connect the fuel line to carburetor to the elbow by screwing the nut on the line into the elbow.

- (3) Carburetor to fuel pump line being too close to exhaust manifold has caused vapor lock. To avoid this condition, the line should be reversed in position, thus increasing distance between the line and manifold.
- (4) Open the shutoff valve (N, fig. 52).
- (5) Start the engine and check the fuel lines for leaks. Open the windshield wiper motor air regulating valve (A, fig. 7) and check for proper operation of windshield wiper motors. If sluggish or slow, check for vacuum line leaks.

132. Air Cleaner Assembly

(fig. 48)

a. *Servicing.* Refer to paragraph 66.

b. *Removal.*

- (1) Loosen hose clamp screw securing air intake pipe flexible hose to air cleaner.

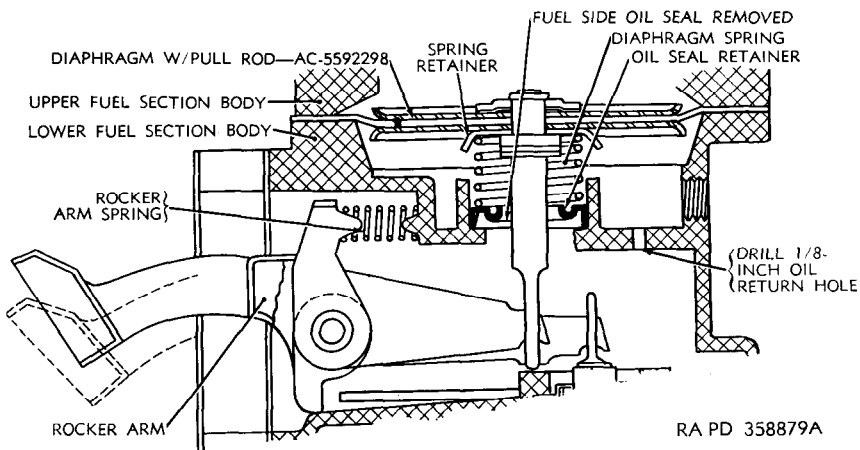

Figure 48. Sectional view of lower fuel section body of fuel pump showing oil return hole.

- (2) Disconnect the fuel tank vent line from the air cleaner. Disconnect the master cylinder vent line by unscrewing the nut on the line from the connector in the tee on the air cleaner. Pull the windshield wiper hose from the windshield wiper vent line.
- (3) Loosen the two wing screws securing the air cleaner extension bracket to the left support bracket assembly.

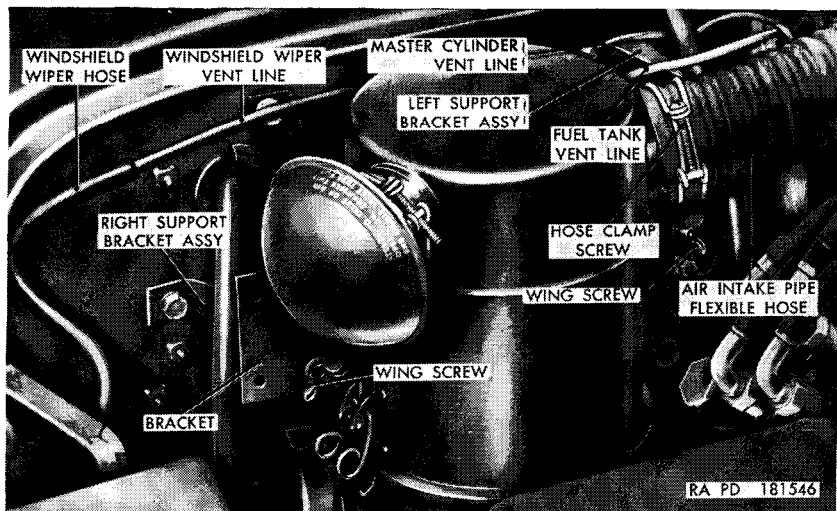

Figure 49. Air cleaner assembly.

Remove the two wing screws and lockwashers securing the extension bracket to the right support bracket assembly.

- (4) Remove the air cleaner and extension bracket by sliding to the right, off the wing screws, and out of the flexible hose.

c. Installation.

- (1) Position the air cleaner assembly in the vehicle with the air outlet inserted inside the air intake pipe flexible hose. Position slotted openings in the extension bracket on the wing screws in the left support bracket assembly and slide the air cleaner toward engine. Aline the holes in the bracket on the air cleaner with the holes in the right support bracket assembly and install the two $\frac{3}{32}$ -inch lockwashers and $\frac{1}{4} \times \frac{3}{4}$ wing screws. Tighten all four wing screws.
- (2) Slide the windshield wiper hose onto the windshield wiper vent line. Connect the master cylinder vent line to the connector in the tee on the air cleaner. Connect the fuel tank vent line to the air cleaner.
- (3) Tighten the hose clamp screw securing the air intake pipe flexible hose to the air cleaner.

133. Fuel Filter Assembly (fig. 50)

a. Removal.

- (1) Remove the driver's seat (par. 268).

- (2) Disconnect the fuel line by unscrewing the nut on the end of the line from the fuel filter assembly. Disconnect the vent line by unscrewing the nut on the end of the line from the connector in the fuel filter assembly. Unscrew the connector from the filter only if necessary.

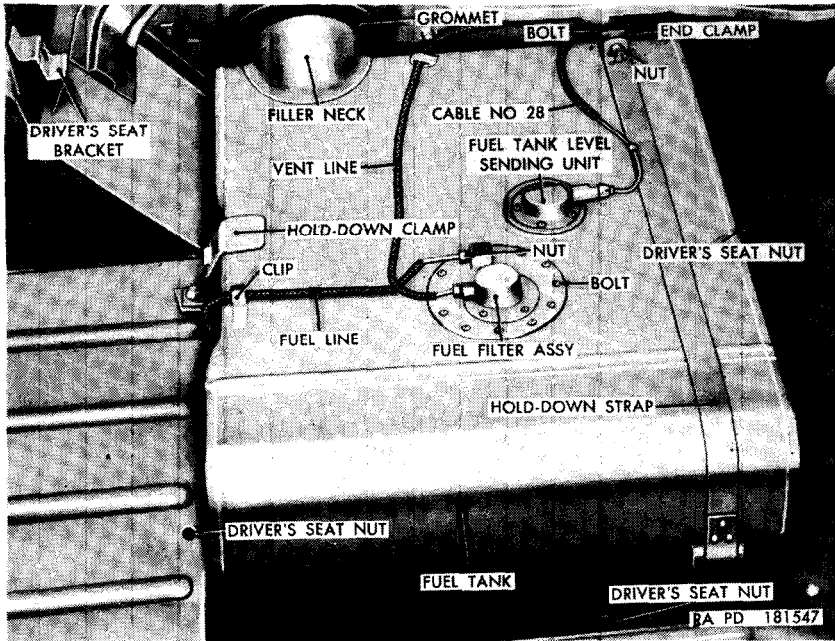

Figure 50. Fuel tank, fuel filter assembly, and fuel tank level sending unit—seat removed.

- (3) Remove the 12 bolts and soft copper sealing washers securing the fuel filter to the fuel tank and remove the filter and the neoprene cover gasket from the tank. Discard gasket.

b. Installation.

- (1) Place a new neoprene gasket on the fuel tank at the opening for the fuel filter gasket assembly. Insert the filter in the tank and align the holes in the gasket, filter, and tank and install the 12 soft copper sealing washers and No. 8 x $\frac{7}{16}$ bolts, tightening bolts evenly.
- (2) Put the end of the fuel line in place in the filter assembly and screw the nut into the fitting. Screw the connector (if removed) into the filter. Put the end of the vent line into the connector and screw the nut into the fitting.
- (3) Install the driver's seat (par. 268).

134. Fuel Filter Element

(fig. 51)

a. Removal.

- (1) Remove the fuel filter assembly (par. 133a).

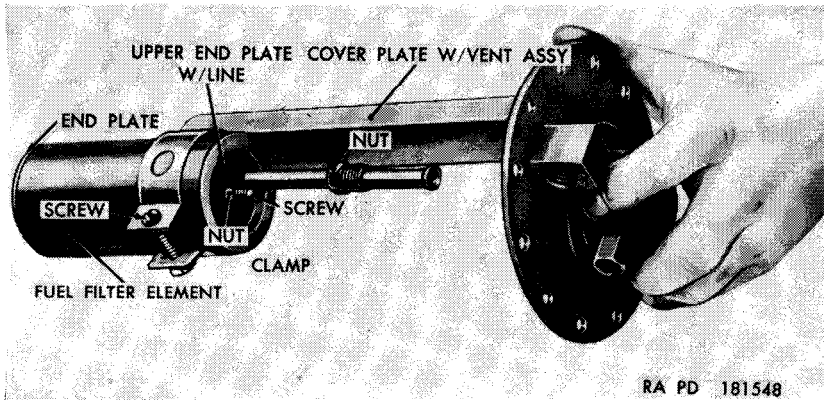

Figure 51. Removing fuel filter element.

- (2) Unscrew the nut on the upper end plate with line, from the cover plate with vent assembly.
- (3) Loosen the screw clamp and slide the fuel filter element out of the clamp.
- (4) Remove the nut and lockwasher from the screw in the element. Pull the screw out of the element, and remove the end plates from the element.
- (5) After removing the element, wash thoroughly in volatile mineral spirits or dry-cleaning solvent. To dry the element, apply compressed air from inside the element to the outside.

b. Installation.

- (1) Slide the end plate over the No. 10 x 6 screw. Slide the fuel filter element over the screw and position on the end plate. Slide the end plate with line over the screw and position on the element. Install a No. 10 lockwasher and nut on the screw.
- (2) Slide the element into the clamp. Screw the nut on the end of the line into the cover plate. Tighten the screw in the clamp.
- (3) Install the fuel filter assembly (par. 133b).

135. Fuel Lines and Fittings

Note. The key letters noted in parentheses are in figure 52, except where otherwise indicated.

a. Flexible Fuel Line.

- (1) *Removal.* Unscrew the nut (U) on the fuel line (T) from the fitting on the flexible fuel line (AA). Unscrew the flexible fuel line (AA) from the elbow (BB) on the fuel and vacuum pump (V).
- (2) *Installation.* Screw the flexible fuel line (AA) into the elbow (BB) on the fuel and vacuum pump (V). Screw the nut (U), on the end of the fuel line (T), into the fitting on the end of the flexible fuel line (AA).

b. Fuel Line (Fuel and Vacuum Pump Flexible Fuel Line-To-Primer Line Pipe Tee).

- (1) *Removal.* Unscrew the nut (U), on the end of the fuel line (T), from the fitting on the flexible fuel line (AA). Unscrew the nut (R) from the connector (Q) in the pipe tee (P). Remove the bolt, nut, and lockwasher securing the fuel line-to-fender splasher clip (S) and remove the line.
- (2) *Installation.* Screw the nut (R) into the connector (Q) in the pipe tee (P). Screw the nut (U), on the end of the fuel line (T), into the fitting on the flexible fuel line (AA). Position the fuel line-to-fender splasher clip (S), over the hole in the fender splasher, insert bolt through clip and splasher, and install lockwasher and nut on bolt.

c. Fuel Line (Shutoff Valve-To-Tank Elbow).

- (1) *Removal.* Unscrew the nut on the rear end of the fuel line (J) from the elbow (D). Unscrew the nut (L) on the front end of the fuel line (J) from the connector (M). Remove the nut and bolt securing the fuel line-to-dash bracket clip (K). Remove the screws securing the two fuel line-to-floor pan clips (F and H) to the underside of the floor pan and remove the line.
- (2) *Installation.* Position the fuel line (J) in the vehicle. Screw the nut (L) on the front end of the line into the connector (M) on the shutoff valve (N). Screw the nut on the rear end of the fuel line (J) onto the elbow (D). Position the fuel line-to-dash bracket clip (K) on the dash bracket, insert bolt through the clip and the bracket, and install the nut on the bolt. Working underneath the vehicle, position the two fuel line-to-floor pan clips (F and H) on the floor pan and install the screws through the clips and into floor pan.

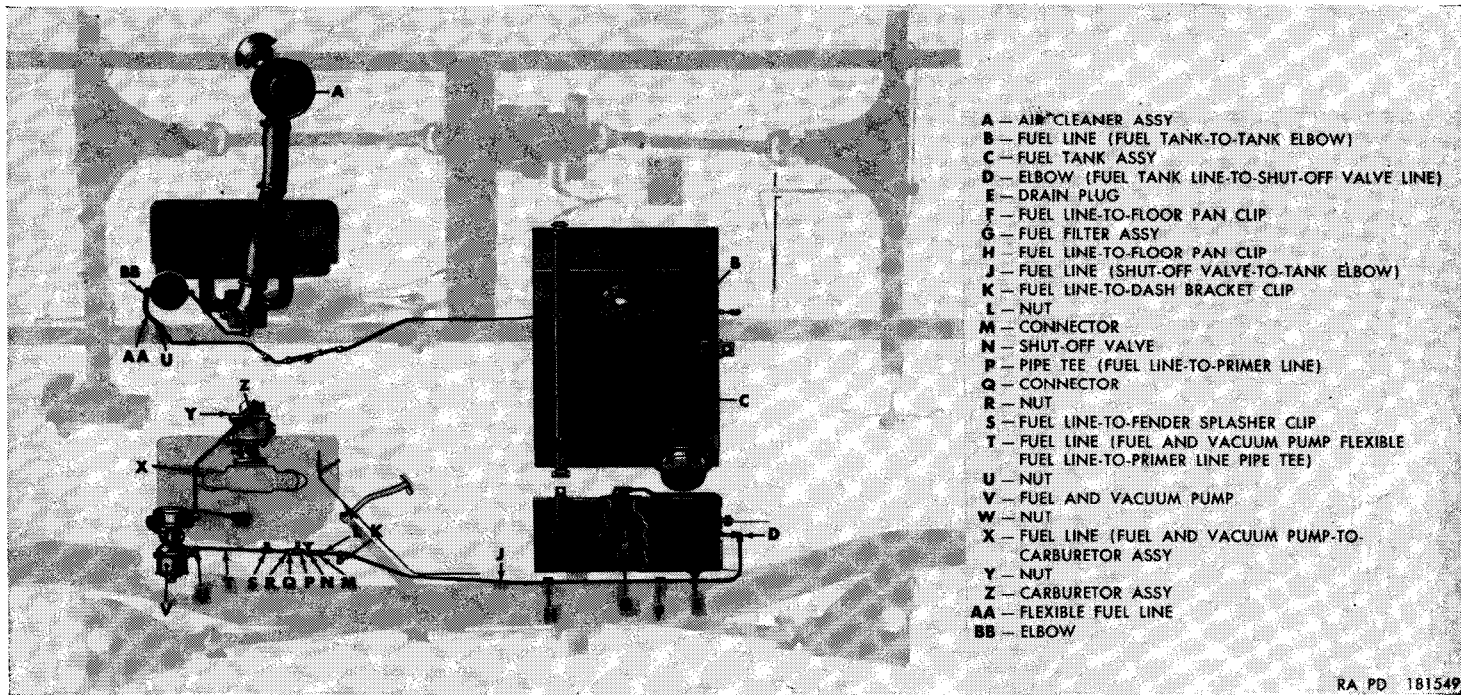

RA PD 181549

Figure 52. Fuel and air intake system.

d. Fuel Line (Fuel Tank-To-Tank Elbow).

- (1) *Removal.* Unscrew the nut on the rear of the fuel line (B) from the elbow (D). Unscrew the nut on the front end of the fuel line (fig. 50) from the fuel filter assembly. Bend the clip (fig. 50) securing the fuel line to the tank and remove the line by pulling it through the floor pan from the top.
- (2) *Installation.* Position the fuel line (fig. 50) in the vehicle by inserting through the floor pan from the top. Screw the nut on the front end of the line into the fuel filter assembly, and bend the clip on the top of the tank down over the fuel line. Screw the nut on the rear end of the fuel line (B) onto the elbow (D). On early production vehicles, install fuel and vent lines as described in (a) through (c) below, to prevent chafing by the driver's seat frame support gusset.
 - (a) Bend fuel and vent lines upward, at fuel tank, so that vent line will locate above the fuel line (fig. 48).
 - (b) Bend fuel and vent lines away from seat frame support gusset and against fuel tank after the lines are connected to the fuel tank.
 - (c) Secure lines together with friction tape at point of contact with fuel tank to prevent chafing.

e. Fuel Line (Fuel and Vacuum Pump-To-Carburetor Assembly).

- (1) *Removal.* Unscrew the nuts (W and Y) on the ends of the fuel line (X), from the elbow on the pump, and the elbow on the carburetor assembly, and remove the line.
- (2) *Installation.* Position the fuel line (X) between the fuel and vacuum pump and the carburetor assembly. Screw the nuts (W and Y) on the ends of the line into the elbow on the carburetor and the elbow on the fuel and vacuum pump respectively.

f. Fuel Shutoff Valve.

- (1) *Removal.* Unscrew the nut (L) on the front end of the fuel line (J) from the connector (M), and unscrew the connector from the shutoff valve (N). Unscrew the shutoff valve from the pipe tee (P).
- (2) *Installation.* Screw the shutoff valve (N) into the pipe tee (P) with shutoff valve handle at the top. Screw the connector (M) into the shutoff valve. Position the fuel line (J) in the connector (M) and screw the nut (L) into the connector.

g. Pipe Tee.

- (1) *Removal.* Unscrew the nut (R) from the connector (Q). Unscrew the connector from the pipe tee (P). If primer line is connected to the pipe tee, disconnect the line from the pipe tee. Unscrew the pipe tee from the shut-off valve (N).
- (2) *Installation.* Screw the pipe tee (P) onto the shutoff valve (N). Screw the connector (Q) into the pipe tee. Screw the nut (R) into the connector (Q). If primer pump is installed in vehicle, connect the line to the pipe tee.

136. Fuel Tank Replacement

(fig. 50)

a. Removal.

- (1) Remove the drain plug (E, fig. 52) from the bottom of the tank and drain the fuel into a suitable container.
- (2) Remove the driver's seat (par. 268).
- (3) Remove the fuel tank level sending unit assembly (par. 189).
- (4) Remove the fuel filter assembly (par. 133a).
- (5) Bend up the clip on the vent line and swing the line up and out toward the left side of the vehicle.
- (6) Bend up the clip on the fuel line. Loosen the nut connecting the line to the elbow (D, fig. 52). Swing the line at the top of the tank toward the right rear of the vehicle to clear the top of the tank.
- (7) Remove the fuel tank filler cap with chain assembly by turning the cap counterclockwise and unhooking the chain from inside the fuel tank filler neck.
- (8) Remove the bolt, lockwasher, and hold-down clamps at the rear of the tank. Remove the bolt and nut from the end clamp and the hold-down strap with antisqueak and swing the strap up toward the right side of the vehicle.
- (9) Slide the tank to the right until the filler neck has cleared the grommet in the filler neck opening in the side of the body and remove the tank. Remove the five fuel tank antisqueaks and one end clamp antisqueak. These will stick on the tank, the vehicle body, or the end clamp.

b. Installation.

- (1) Before installing the new tank, make sure that the four fuel tank antisqueaks and one end clamp antisqueak are in place as indicated by marks on the tank which was removed. Position the tank in the vehicle and carefully

slide the filler neck through the grommet in the opening in the side of the body.

- (2) Install the hold-down clamp at the rear of the tank, and secure in place with $\frac{5}{16}$ -18 x $\frac{7}{8}$ bolt and lockwasher. Place the hold-down strap in position on the top of the tank over the antisqueak, install the bolt through the end clamp and the hold-down strap, and screw the nut onto the bolt.
- (3) Install the fuel tank level sending unit assembly (par. 189).
- (4) Install a new fuel filter element (par. 134) and the fuel filter assembly (par. 133).
- (5) Connect the vent line to the fuel filter by screwing the nut on the end of the line into the fitting on the filter. Bend the clip on the tank over the line. Connect the fuel line to the fuel filter by screwing the nut on the end of the line into the filter. Bend the clip on the tank over the line. Connect the fuel line to the elbow (D, fig. 52) by tightening the nut on the end of the line.
- (6) Install the drain plug ($\frac{1}{4}$ -in. pipe plug) (E, fig. 52) in the bottom of the tank. Install the fuel tank filler cap with chain assembly by hooking the chain into the loop inside the filler neck. Fill the tank with fuel and install filler cap on fuel tank turning clockwise to lock cap on tank.
- (7) Start the engine and make sure there are no leaks at fuel line connections. Check the fuel gage for proper operation of the fuel tank level sending unit.
- (8) Install the driver's seat (par. 268).

Section IX. EXHAUST SYSTEM

137. Description

The exhaust system (fig. 53) consists of the exhaust pipe, exhaust pipe extension, muffler, exhaust pipe extension support bracket, and muffler support clamp bracket. The tail pipe is part of the muffler and has a flange at the rear end for attaching the fording kit extension.

138. Exhaust Pipe and Extension

(fig. 53)

a. Exhaust Pipe.

- (1) *Removal.* Remove the nut from the stud in the flange of the exhaust manifold. Remove the nut and bolt holding the flange of the exhaust pipe to the exhaust manifold.

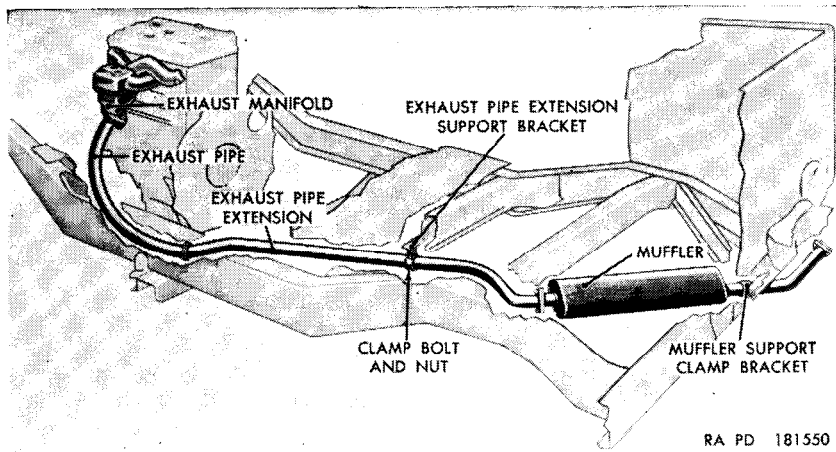

Figure 53. Exhaust system.

Remove the three nuts and bolts holding the flange of exhaust pipe to the flange of the exhaust pipe extension. Separate these flanges, drop the exhaust pipe straight down, and remove. Remove and discard the two gaskets.

- (2) *Installation.* Clean the gasket surfaces of the flanges. Place a new gasket on the front flange of the exhaust pipe. Position the exhaust pipe over the stud in the exhaust manifold and start the $\frac{3}{8}$ -inch nut on the stud but do not tighten. Insert $\frac{3}{8} \times 1\frac{1}{2}$ bolt through the flanges and gasket, entering the bolt from the top. Start $\frac{3}{8}$ -inch nut on the bolt. Place a new gasket on the flange on the rear of the exhaust pipe, position against the exhaust pipe extension flange, insert three $\frac{3}{8} \times 1\frac{1}{2}$ bolts through the flanges and gasket, and start the three $\frac{3}{8}$ -inch nuts onto the bolts. Tighten both nuts securing the exhaust pipe to the exhaust manifold. Tighten the three nuts and bolts securing the exhaust pipe extension to the exhaust pipe.

b. Exhaust Pipe Extension.

- (1) *Removal.* Remove the three nuts and bolts securing the exhaust pipe extension to the exhaust pipe. Remove the three nuts and bolts securing the exhaust pipe extension to the muffler. Remove the nut, bolt, and spacer securing the exhaust pipe extension support bracket to the frame cross member. Loosen the bolt securing the muffler support clamp bracket to the frame rear cross member and slide the muffler back about one inch. Separate flanges at both ends of the exhaust pipe extension and remove the pipe and bracket. Discard gaskets.

- (2) *Installation.* Clean the gasket surfaces of flanges. Place exhaust pipe extension in approximate position under the vehicle, with the offset end toward the muffler. Insert the $\frac{5}{16}$ x 1 bolt through the hole in the frame cross member, from the top, and place the spacer over the bolt. Raise the exhaust pipe extension into place, insert the bolt through the exhaust pipe extension support bracket and start the $\frac{5}{16}$ -inch nut onto the bolt. Place a new gasket on the front flange of the exhaust pipe extension and insert three $\frac{3}{8}$ x $1\frac{1}{2}$ bolts through the exhaust pipe flange, gasket, and exhaust pipe extension front flange. Start the $\frac{3}{8}$ -inch nuts onto the bolts but do not tighten. Place a new gasket on the muffler front flange. Insert three $\frac{3}{8}$ x $1\frac{1}{2}$ bolts through the muffler flange, gasket, and exhaust pipe extension rear flange. Slide the muffler forward until flanges are together. Start the $\frac{3}{8}$ -inch nuts on the bolts but do not tighten. Tighten bolts and nuts securing the exhaust pipe extension to the exhaust pipe. Tighten bolts and nuts securing the muffler to the exhaust pipe extension. Tighten the bolt and nut securing the exhaust pipe extension support bracket to the frame cross member. Tighten the clamp bolt and nut in the exhaust pipe extension support. Tighten the bolt securing the muffler support clamp bracket to the frame rear cross member. Start engine and check all exhaust connections for leaks.

139. Muffler and Bracket

(fig. 53)

a. Removal. Remove three nuts and bolts securing the muffler to the exhaust pipe extension. Remove the bolt and lockwasher securing the muffler support clamp bracket to the frame rear cross member and remove the muffler.

b. Installation. Insert three $\frac{3}{8}$ x $1\frac{1}{2}$ bolts through the muffler flange and place a new gasket over the bolts. Raise the muffler into position and insert the bolts through the exhaust pipe extension flange. Start the $\frac{3}{8}$ -inch nuts onto the bolts but do not tighten. Insert the $\frac{5}{16}$ x $1\frac{1}{8}$ bolt with lockwasher through the muffler support clamp bracket and start the threads into the hole in the frame rear cross member. Tighten the three bolts securing the muffler to the exhaust pipe extension. Tighten the bolt securing the muffler support clamp bracket to the frame rear cross member. Start the engine and check all exhaust connections for leaks.

Section X. IGNITION SYSTEM

140. Description and Data

a. Description.

- (1) *General.* The ignition system (fig. 54) consists of the batteries, ignition switch, distributor with coil assembly, spark plugs, and primary and secondary circuit cables. The distributor with coil assembly supplies high voltage current to the spark plugs at timed intervals. The entire system is shielded for radio interference suppression and is completely waterproofed.

Note. The batteries are necessarily a part of each of the various electrical systems. The operations on batteries are in paragraphs 154 through 164.

- (2) *Distributor with coil assembly* (fig. 55). The distributor, capacitor, and ignition coil comprise a single unit with automatic spark advance built-in to vary the ignition timing for most efficient operation. The assembly is located on the right side of the engine and is driven from the camshaft.
- (3) *Spark plugs.* The 14-mm spark plugs are shielded and waterproof, with built-in resistors for radio interference suppression.
- (4) *Spark plug cable assemblies* (fig. 55). The spark plug cable assemblies are fully shielded and waterproof, with threaded connectors on each end.
- (5) *Circuits* (fig. 54). There are two distinct circuits in the ignition system, the primary circuit and the secondary circuit. The primary, or low voltage circuit, consists of the batteries, ignition switch, distributor points, capacitor, and the primary winding of the ignition coil. The secondary, or high voltage circuit, consists of the secondary winding of the ignition coil, distributor rotor, distributor cover assembly, distributor cap assembly, spark plug cable assemblies, and spark plugs.

b. Data.

Distributor with coil assembly:

Manufacturer	Electric Auto-Lite Co
Model	IAU-4006UT
Rotation	Counterclockwise
Type advance	Centrifugal
Breaker point opening	0.020 in.
Breaker arm spring tension	17 to 20 oz
Firing order	1-3-4-2
Voltage	24
Cam angle	38 deg

Ignition coil:

Manufacturer	Electric Auto-Lite Co
Model	CT-4002
Voltage	24

Spark plugs:

Ordinance number	7524258
Thread size	14-mm
Electrode gap	0.030 in.

141. Organizational Maintenance

Periodic inspection and lubrication of the ignition system is the responsibility of the using organization. See lubrication order (par. 66) for detailed instructions. Information and data for ignition system maintenance are given in paragraphs 142 through 146. Operations not described are the responsibility of ordnance maintenance units. However, in an emergency, using organizations may perform ordnance maintenance unit operations, provided permission is obtained from the ordnance maintenance unit.

142. Ignition Timing

a. The ignition is timed by adjusting the distributor so the distributor points open at the correct firing intervals. Since the distributor with coil assembly is sealed, a special adapter (fig. 59) is required to connect the timing light.

b. Mark the position of No. 1 spark plug cable assembly (fig. 55) on the side of the distributor with coil assembly, to aid in determining the position of the distributor rotor after the distributor cover and cap assemblies are removed.

c. Remove six lockwasher screws securing the distributor cover and cap assemblies (fig. 55) and remove the assemblies. Turn the crankshaft until the distributor points are open, with the breaker lever (fig. 56) on one of the four high points of the cam. Loosen the screw securing the stationary contact bracket to the breaker plate. Adjust the point gap by turning the adjusting eccentric (fig. 57) until a 0.020-inch feeler gage will enter between the points with a slight drag on the gage. Tighten the screw securing the stationary contact bracket to the breaker plate and again check the point gap.

d. On early production vehicles, turn the crankshaft with a crank, or suitable socket wrench, until the distributor rotor points to the mark (*b* above) and the timing mark "5 BTC" on the flywheel is alined with the pointer in the timing hole in the flywheel housing. On late production vehicles, aline the hole in the back of the fan and generator drive pulley (fig. 57) with the "5" mark on the timing gear cover (fig. 57).

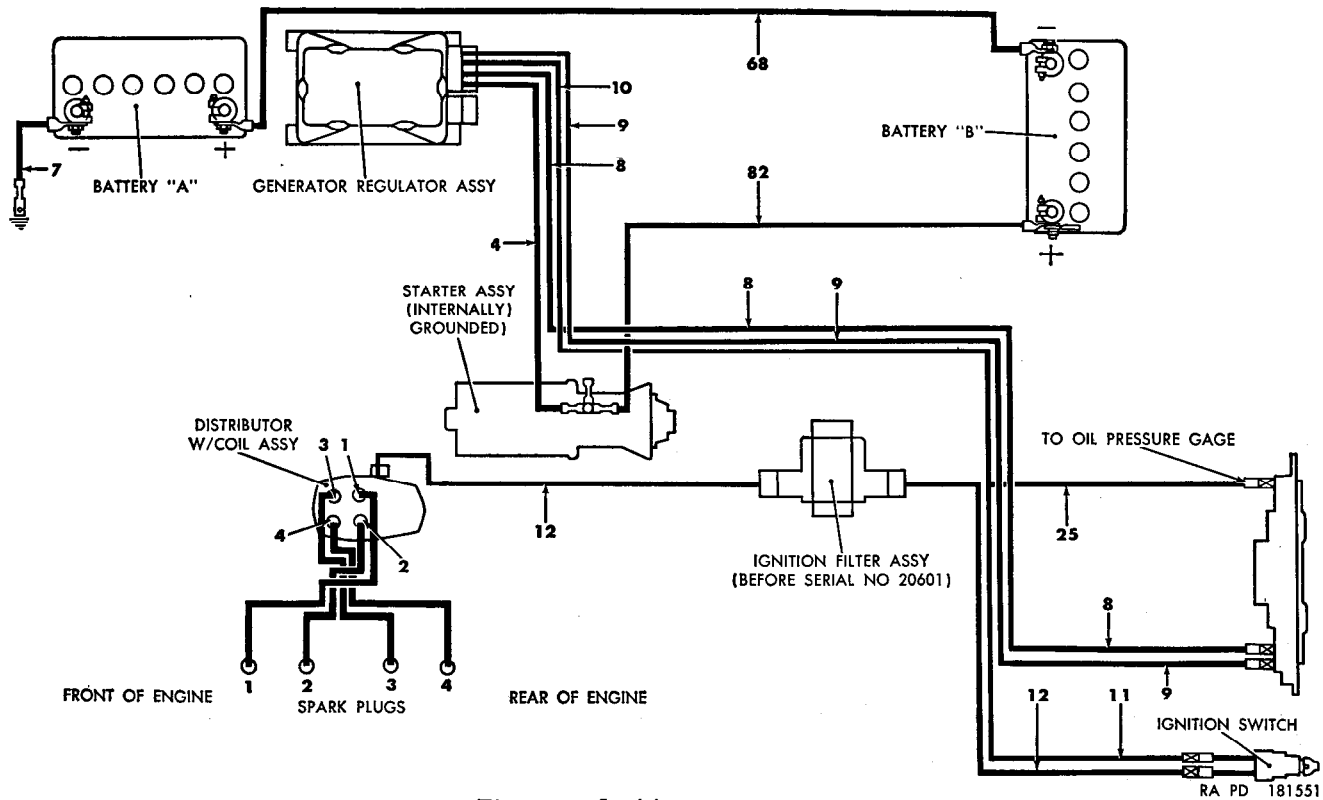

Figure 54. Ignition system circuit.

RA PD 181551

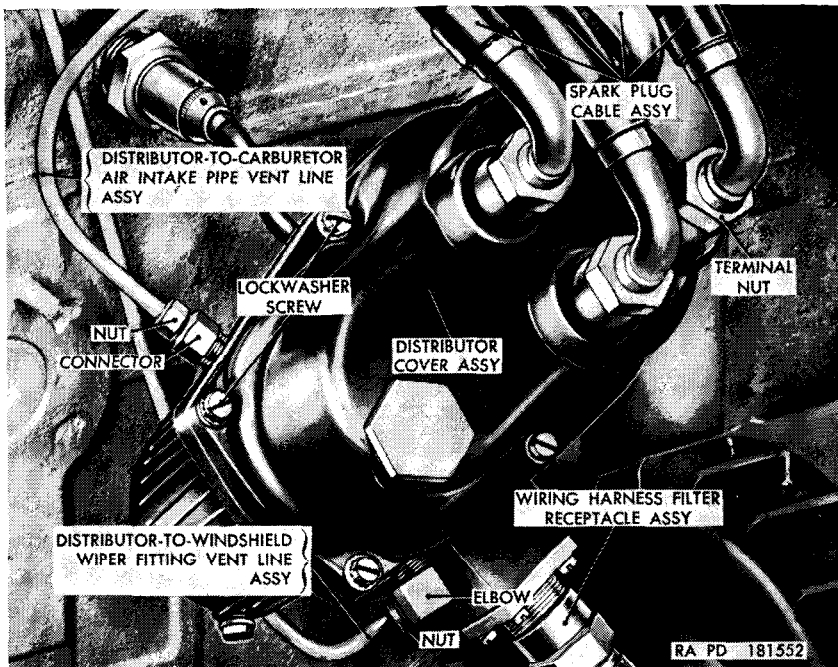

Figure 55. Distributor with coil assembly—installed.

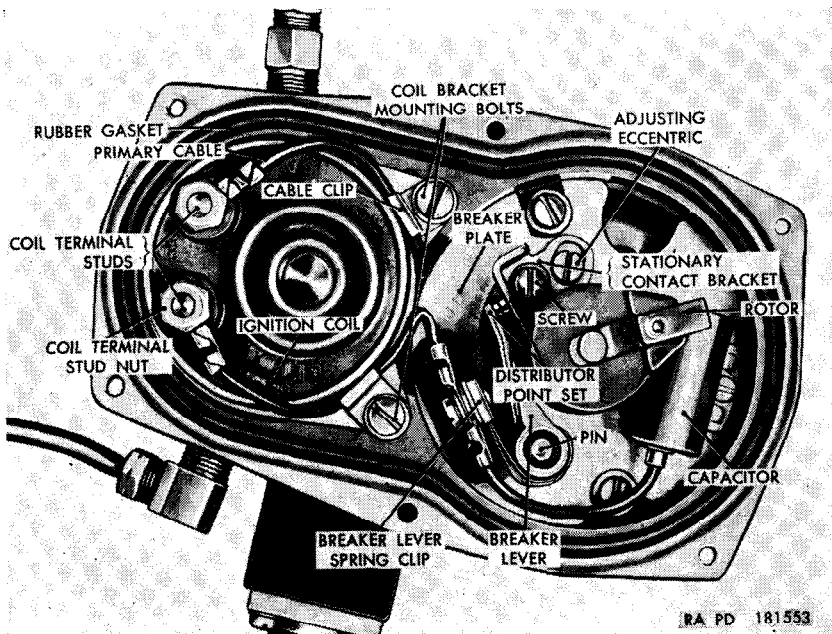

Figure 56. Distributor with coil assembly—distributor cover and cap assemblies removed.

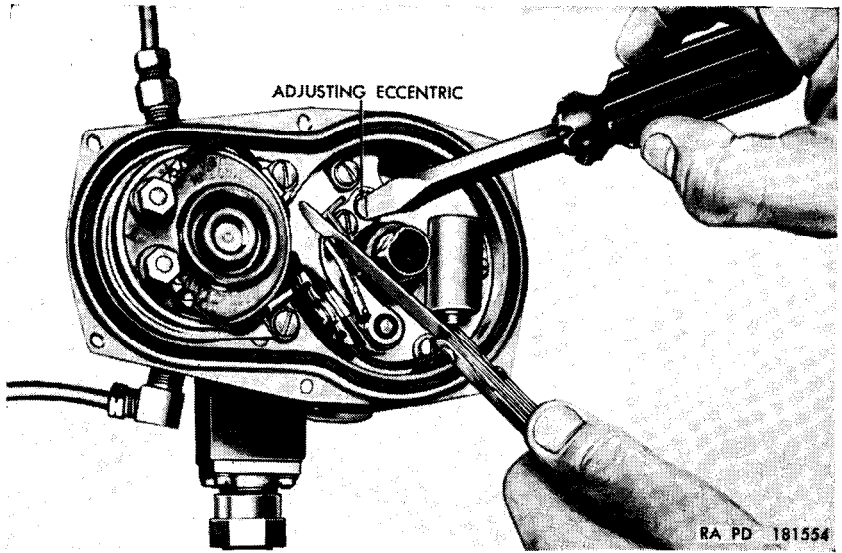

Figure 57. Adjusting distributor point set.

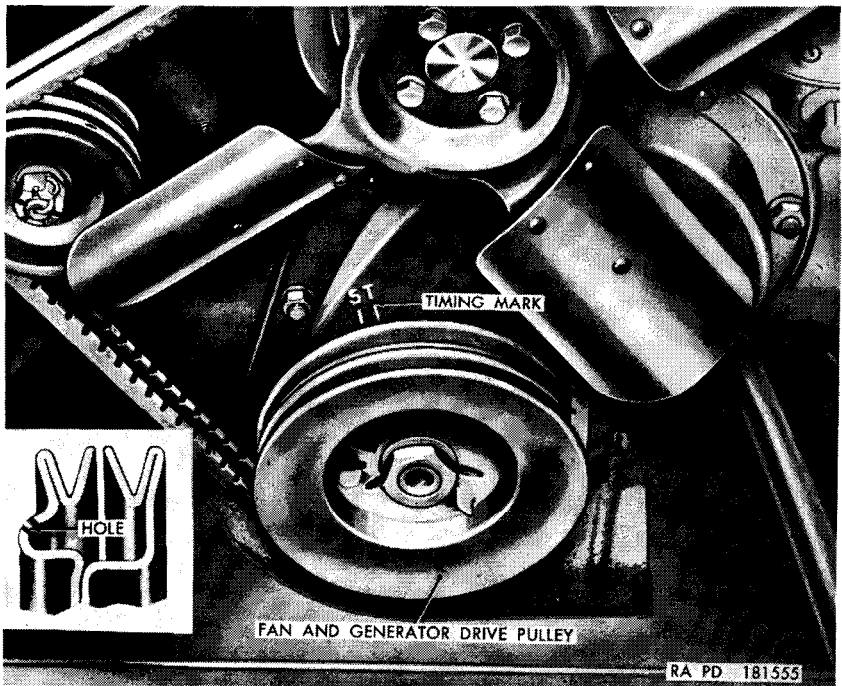

Figure 58. Timing marks on fan and generator drive pulley and timing gear cover.

e. Loosen the mounting clamp screw located under the distributor with coil assembly toward the rear of the distributor mounting bracket. Turn the distributor counterclockwise until the distributor points are closed, and the distributor rotor is pointed to the No. 1 position (*b* above). Turn the distributor clockwise slowly until the points start to open. Tighten the mounting clamp screw. The ignition timing is now roughly adjusted.

f. Be sure that the rubber gasket (fig. 56) is seated in its groove. Position the distributor cover and cap assemblies over the gasket and secure with six No. 10 x $1\frac{1}{16}$ lockwasher screws (fig. 55).

g. Unscrew the terminal nut securing the spark plug cable assembly to No. 1 spark plug (fig. 59). Push the timing light adapter (fig. 59) over the spark plug and connect the No. 1 cable to the adapter. Connect one terminal of the timing light to the adapter and the other terminal to ground at any convenient place on the engine.

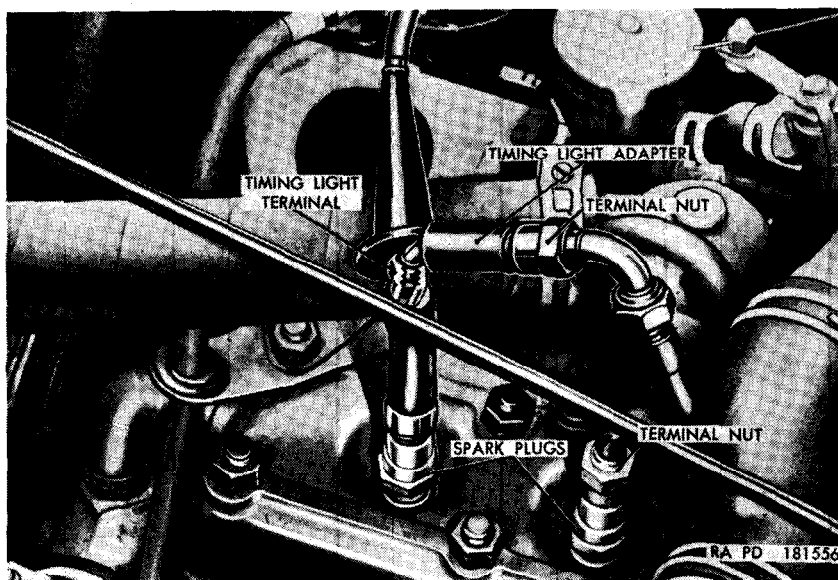

Figure 59. Timing light adapter—installed.

h. Start the engine and run it at idle speed. Direct the beam from the timing light toward the timing marks (fig. 58). Loosen the mounting clamp screw under the distributor with coil assembly and turn the distributor until the timing marks appear together. When the timing marks appear together, tighten the mounting clamp screw.

i. Stop the engine and remove the timing light. Pull the timing light adapter (fig. 59) from the spark plug and unscrew the terminal nut from the adapter. Install No. 1 spark plug cable assembly by screwing the terminal nut onto the spark plug.

143. Distributor

a. *Distributor Cap Assembly* (fig. 60).

- (1) *Removal.* Remove the six lockwasher screws (fig. 55) securing the distributor cover and cap assemblies and remove the assemblies. Remove the three screws and lockwashers holding the distributor cap assembly to the distributor cover assembly and remove the cap. Do not lose the four cap sealing washers between the cover and cap assemblies.

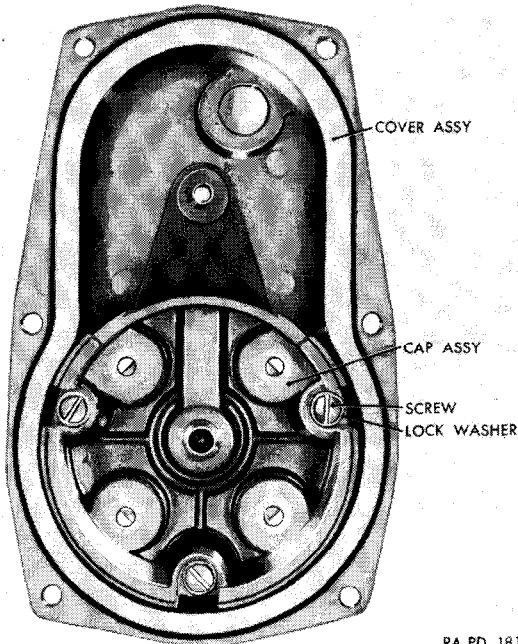
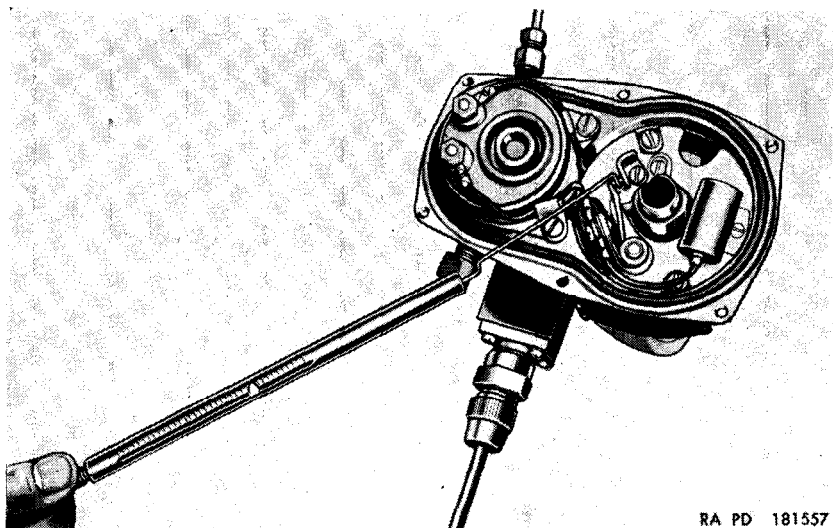

Figure 60. Distributor cover and cap assemblies.

- (2) *Installation.* Install the four cap sealing washers on the four projections on the top of the cap assembly. Position cap assembly inside the cover assembly and secure in place with three No. 8-32 x 1 screws and internal-teeth lockwashers. Install the distributor cover and cap assemblies on the distributor (par. 142f).

b. Distributor Point Set (fig. 56).

- (1) *Removal.* Remove six lockwasher screws (fig. 55) securing the distributor cover and cap assemblies and remove the assemblies. Loosen the screw securing the breaker lever spring clip and slide the breaker lever spring up and out of the clip. Lift the breaker lever up and off the pin. Remove the screw securing the stationary contact bracket and remove the bracket.
- (2) *Installation.* Place the stationary contact bracket over the pin in the breaker plate, and over the adjusting eccentric. Install the No. 8 x $\frac{3}{16}$ screw securing the bracket to the plate, but do not tighten. Place the breaker lever onto the pin on the breaker plate and position the slot in the breaker lever spring over the screw, inside the breaker lever spring clip. Push the breaker lever onto the pin as far as it will go and tighten the screw securing the clip, making sure that the spring and terminals are alined.
- (3) *Adjustment.* Test the distributor breaker lever spring tension with a contact spring gage as shown in figure 61. The points should start to open with a pull of 17 to 21 ounces. Adjust the tension by bending the breaker lever spring if necessary. Always have gage at right angle to the points, as shown in figure 61. Check the point adjustment (par. 142c). Install the distributor cover and cap assemblies (par. 142f).



RA PD 181557

Figure 61. Testing distributor breaker lever spring tension.

c. Capacitor (fig. 56).

- (1) *Removal.* Remove the six lockwasher screws (fig. 55), and remove the distributor cover and cap assemblies. Loosen the screw securing the breaker lever spring clip, and lift the capacitor cable terminal from the screw. Remove the screw securing the capacitor to the breaker plate and remove the capacitor.
- (2) *Installation.* Position the capacitor on the breaker plate and secure it with one No. 6 x $\frac{3}{16}$ screw. Place the capacitor cable terminal on the screw securing the breaker lever spring clip and tighten the screw. Install the distributor cover and cap assemblies (par. 142f).

d. Rotor (fig. 56).

- (1) *Removal.* Remove the six lockwasher screws (fig. 55), and remove the distributor cover and cap assemblies. Lift the rotor up and off the cam.

Note. If the rotor is tight, use care in removing as it is easily broken.

- (2) *Installation.* Place the rotor on top of the cam, with the flat spot in the bore of the rotor alined with the flat spot on the cam. Press the rotor into place by hand. Do not hammer on top of the rotor. Install the distributor cover and cap assemblies (par. 142f).

e. Ignition Filter Assembly (fig. 54).

Note. The ignition filter assembly is a separate unit mounted in the engine compartment in vehicles before serial No. 20601. Beginning with vehicle serial No. 20601, the filter is installed in the wiring harness filter receptacle assembly on the distributor body.

- (1) *Removal.* In vehicles before serial No. 20601, unscrew the nuts securing the cables to the connectors on both ends of the ignition filter assembly. Remove four screws and lockwashers securing the filter assembly and remove the assembly.
- (2) *Installation.* Place the ignition filter assembly in position (on the fire wall below the air cleaner assembly), and secure with four screws and lockwashers. Screw the cables onto the connectors on the filter assembly.

f. Wiring Harness Filter.

- (1) *Removal.* In vehicles after serial No. 20601, unscrew and remove the six lockwasher screws (fig. 53) securing the distributor cover assembly to the distributor housing and remove the assembly. Loosen the nut (fig. 56) on the positive terminal of the ignition coil and remove nut, washer, and terminal of ignition coil primary cable.

Loosen the coil bracket mounting bolt securing the cable clip, for the primary cable, to the coil mounting bracket and remove bolt, lockwasher, and clip. Unscrew the nut (T, fig. 33) securing the primary cable to the wiring harness filter receptacle, and pull the cable from the receptacle. Remove the four lockwasher screws securing the wiring harness filter receptacle (fig. 55) to the distributor housing. Pull the receptacle assembly from the distributor housing, and separate the capacitor from the receptacle.

- (2) *Installation.* Insert the wiring harness filter into the wiring harness filter receptacle, contact end first, until the flange of the filter rests against the flange of the receptacle. Insert the terminal end of the ignition coil primary cable in the distributor housing. Pull the cable through sufficiently to place the cable terminal over the positive terminal of the ignition coil and secure with No. 10 washer and No. 10-32 nut. Secure the receptacle to the distributor housing with four No. 6-32 x $1\frac{1}{32}$ lockwasher screws. Position and secure the ignition coil primary cable into the distributor housing. Pull the cable clip, No. 10 lockwasher, and a No. 10-32 x $\frac{7}{16}$ fillister-head bolt. Insert the primary cable plug into the receptacle, and install the nut. Position the distributor cover assembly on the top of the distributor housing and secure with six No. 10- $1\frac{1}{16}$ fillister-head, internal-teeth lockwasher screws.

144. Ignition Coil

a. Removal. Remove the six lockwasher screws (fig. 55) and remove the cover and cap assemblies. Remove the two coil terminal stud nuts, and lift the terminals from the studs. Remove the coil bracket mounting bolts and two cable clips. Lift the coil straight out and remove.

b. Installation. Slide the coil into position, with terminals spaced as shown in figure 56. Place the cable terminals on the coil terminal studs. Arrange the cables as shown in figure 56 and secure each terminal with a No. 10 coil terminal stud nut and lockwasher. Place the cable clips in position to hold cables. Install one No. 10 x $\frac{7}{16}$ coil bracket mounting bolt, through each cable clip and hole in the coil bracket and into the hole in the distributor base. Install the distributor cover and cap assemblies (par. 142f).

145. Spark Plugs and Spark Plug Cable Assemblies

(fig. 59)

a. Spark Plugs.

- (1) *Removal.* Unscrew the terminal nuts securing the spark plug cable assemblies to the spark plugs. Remove all dirt from the recesses in the cylinder head around the spark plugs. Loosen the spark plugs with a deep socket wrench and remove the plugs. Discard the spark plug gaskets.
- (2) *Installation.* Measure the electrode gap with a wire feeler gage, and adjust to 0.030 inch. Place new gaskets over the spark plug threads. Install the plugs and tighten to torque of 25–30 pound-feet. Screw the terminal nuts of the spark plug cable assemblies onto the spark plugs.

b. Spark Plug Cable Assemblies.

- (1) *Removal.* Mark the spark plug cable assemblies for identification. Unscrew the terminal nuts (fig. 55) and disconnect the cables from the distributor cover assembly. Unscrew the terminal nuts and disconnect the cables from the spark plugs, and remove the cables.
- (2) *Installation.* Place the spark plug cable assemblies in position, with the long cable for No. 1 cylinder. Start the terminal nuts onto the threads on the spark plugs, but do not tighten until the cables are alined. Start the terminal nuts onto the threads on the distributor cover assembly (fig. 55), making certain that the correct firing order is maintained. Aline the cables at the distributor cover and spark plugs, to avoid kinks or sharp bends. Tighten the terminal nuts on both ends of the cables.

146. Distributor With Coil Assembly

(fig. 55)

a. Removal.

- (1) Mark the spark plug cable assemblies for identification at installation.
- (2) Unscrew the terminal nuts securing the spark plug cable assemblies to the distributor cover assembly, and disconnect the cable assemblies.
- (3) Unscrew the nut securing the distributor-to-carburetor air intake pipe vent line assembly to the connector on the distributor, and pull the line from the connector. Unscrew the connector. Unscrew the nut securing the distributor-to-windshield wiper fitting vent line assembly to the elbow and pull the line from the elbow. Unscrew the elbow.

- (4) Unscrew the nut securing cable No. 12 (fig. 54) to the wiring harness filter receptacle assembly, and disconnect the cable.
- (5) Remove the mounting clamp screw and flat washer securing the distributor with coil assembly to the spark advance control arm, located under the distributor. Remove the distributor by lifting up and toward the right side of the vehicle. Do not lose the spark advance control arm thrust washer located between the distributor and the spark advance control arm.

b. Installation.

- (1) Make sure that the distributor drive shaft friction spring is in place on the lower end of the distributor drive shaft assembly. Place the spark advance control arm thrust washer onto the bottom of the distributor. Insert the drive shaft into the bore in the side of the cylinder block, and lower the distributor with coil assembly into position. Make sure that the offset tang on the end of the drive shaft enters the slot in the oil pump drive gear. When the tang is seated properly, the distributor will rest on the spark advance control arm.
- (2) Put the flat washer onto the $\frac{1}{4}$ x $\frac{5}{8}$ mounting clamp screw and start the screw through the spark advance control arm into the bottom of the distributor with coil assembly. Do not tighten this screw until the ignition has been timed.
- (3) Insert the No. 12 cable terminal plug into the wiring harness filter receptacle assembly. Start the terminal nut onto the receptacle and tighten with a wrench.
- (4) Screw the elbow into the side of the assembly. Install the distributor-to-windshield wiper fitting vent line assembly in the elbow and screw the nut into the elbow. Screw the connector into the side of the assembly. Install the distributor-to-carburetor air intake pipe vent line assembly in the connector and screw the nut into the connector.

Note. If the other end of the vent line is retained by a mounting clip held under the cylinder stud nut, remove the nut and lift off the vent line clip. Install the nut and tighten to 65 to 75 pound-feet with torque wrench. Install vent line mounting clip over stud and secure on stud with a $\frac{7}{16}$ -20NF jamnut 107824. Installation of the clip on top of stud nut will eliminate bending and twisting of the vent line when nut is tightened.

- (5) Connect the spark plug cable assemblies to the distributor cover assembly by screwing the terminal nuts onto the cover assembly. Be sure that the cables are installed in correct firing order.
- (6) Set the ignition timing (par. 142).

Section XI. STARTING SYSTEM

147. Description and Data

a. Description. The starting system (fig. 62) consists of the starter, the starter switch, and starter pedal assemblies; the batteries, connecting linkage and electrical cables, and in some cases an auxiliary power receptacle for cold-weather starting.

Note. The batteries are necessarily a part of each of the various electrical systems. The operations on batteries are in paragraphs 154 through 164.

The auxiliary power cable receptacle with connecting cables is considered a part of the starting system as it is the connection for the application of any outside power source such as a booster battery or a charging and starting power unit. The starter pedal assembly engages the starter drive pinion with the flywheel ring gears, and also operates the starter switch assembly. The starter assembly (fig. 64) is a fully sealed, waterproof unit, mounted on the front of the flywheel housing, at the right side. The starter switch assembly (fig. 64) is a separate unit, mounted on top of the starter assembly. The drive incorporates an over-running clutch, which automatically disengages when the engine starts. The starter bearings are lubricated at assembly and require no further lubrication.

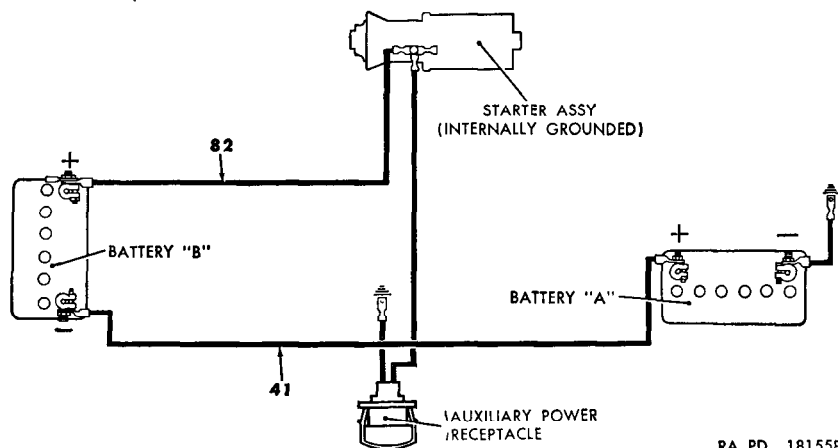

RA PD 181558

Figure 62. Starting system circuit.

b. Data for Starter Assembly.

Manufacturer -----	Electric Auto-Lite Co
Model -----	MCI-4001UT
Voltage -----	24
Cranking speed -----	185 rpm
Drive -----	Overrunning clutch
Switch -----	Mounted on starter

148. Starter Assembly

a. Removal. Loosen the lead-coated nut securing the battery-to-starter cable No. 82 terminal to the positive terminal of battery "B" (fig. 62), and remove the cable from the terminal stud. Pull the cable out of the battery box to avoid accidental contact with the battery terminal. Remove the terminal nut, lockwasher, battery-to-starter cable, generator regulator cable, and auxiliary power receptacle cable (if vehicle is equipped with an auxiliary power receptacle) from the starter switch terminal (fig. 63). Remove the bolt and lockwasher securing the starter assembly to the starter support (fig. 64). Remove the nut and copper washer (fig. 64) from bolt, and remove the bolt and copper washer from the starter clutch and pinion housing assembly and the flywheel housing. Remove the screw and lockwasher in the upper hole of the clutch and pinion housing assembly securing the starter as-

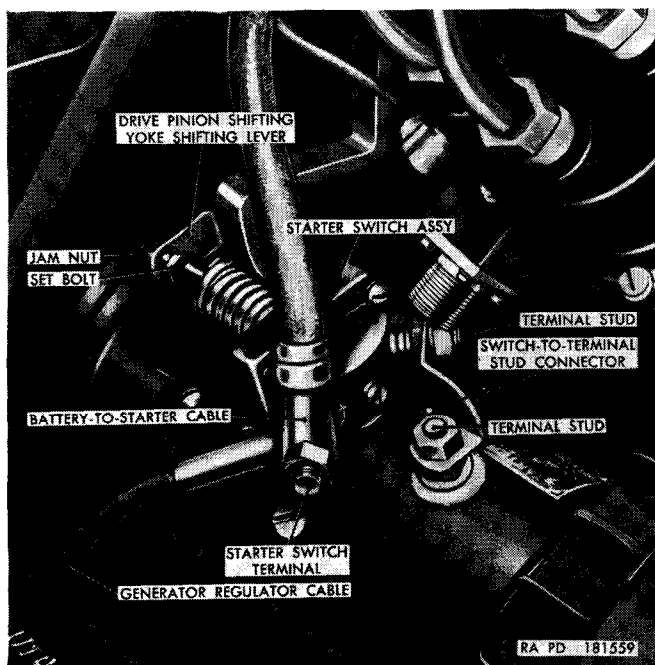

Figure 63. Starter switch terminal—cable No. 12 removed.

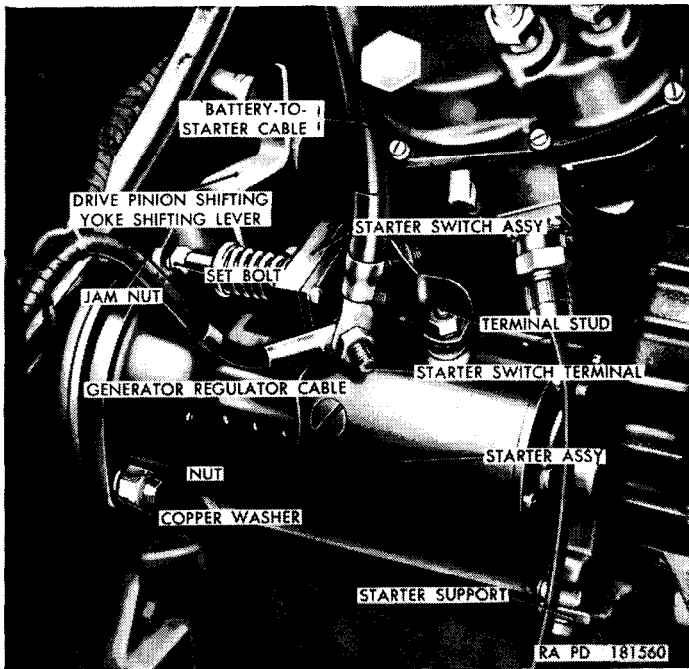

Figure 64. Starter installed on engine.

sembly to the flywheel housing. Remove the starter assembly by pulling straight toward the front of the vehicle until the drive pinion is clear of the flywheel housing.

b. Installation. Insert the drive pinion end of the starter assembly into the flywheel housing, and position the starter. Place a $\frac{1}{2}$ -inch copper washer on the $\frac{1}{2} \times 3\frac{1}{2}$ bolt and insert the bolt through the flywheel housing, through the starter clutch and pinion housing assembly, and install a $\frac{1}{2}$ -inch copper washer and $\frac{1}{2}$ -inch nut on the bolt. Install the $\frac{1}{2} \times 1\frac{1}{4}$ screw and lock washer through the upper hole in the clutch and pinion housing assembly and screw into the flywheel housing. Secure the front of the starter to the starter support (fig. 64) with $\frac{3}{8} \times \frac{7}{8}$ bolt and lockwasher. Place the battery-to-starter cable, generator regulator cable, and the auxiliary power receptacle cable, if used, on the starter switch terminal (fig. 63) and install the $\frac{7}{16}$ -inch lock washer and terminal nut. Coat the starter switch terminal and cable terminals with ignition insulation compound. Insert the battery-to-starter cable through the rubber grommet in the battery box, place the cable terminal onto the stud on the battery "B" positive terminal (fig. 62), and install the $\frac{5}{16}$ -inch lead-coated nut. Coat the battery terminal with artillery and automotive grease (GAA).

149. Starter Switch Assembly

a. Removal. Loosen the nut securing the battery-to-starter cable No. 82 terminal to the positive terminal of battery "B" (fig. 62) and remove the cable, from the terminal stud. Remove the terminal nut and lockwasher securing the battery-to-starter cable (fig. 63), generator regulator cable, and auxiliary power receptacle cable, if used, to the starter switch terminal, and remove the cables. Remove the nut and lockwasher from the terminal stud (fig. 63) on the starter assembly. Remove the nut and lockwasher from the terminal stud (fig. 63) on the starter switch assembly, and remove the switch-to-terminal stud connector (fig. 63). Remove four bolts and lockwashers securing the starter switch assembly to the starter assembly and remove the starter switch assembly.

b. Installation. Place the starter switch assembly on the starter assembly and install four No. 10 x $\frac{5}{8}$ bolts and lockwashers holding switch to starter. Place the switch-to-terminal stud connector (fig. 63) over the terminal studs on the starter and starter switch. Install the $\frac{7}{16}$ -inch nuts and lockwashers securing the connector to the terminal studs. Place the battery-to-starter cable, generator regulator cable, and the auxiliary power receptacle cable, if used, on the starter switch terminal. Install $\frac{7}{16}$ -inch lockwasher and terminal nut. Insert the battery-to-starter cable through the grommet in the battery box and place the terminal over the positive terminal stud on battery "B" (fig. 62). Install the $\frac{5}{16}$ -inch lead-coated nut securing the battery-to-starter cable to the terminal. Coat terminal with artillery and automotive grease (GAA) and check the operation of the starter switch assembly. If the switch does not make contact so that starter operates, adjust (*c* below).

c. Adjustment. Loosen the jamnut (fig. 63) on the setbolt in the drive pinion shifting yoke shifting lever. Depress the starter pedal as far as possible. Adjust the setbolt in or out until the starter switch makes a good contact, and tighten the jamnut. Release the starter pedal, wait a few seconds, and try the pedal again. If adjustment is correct, the starter will operate properly.

150. Auxiliary Power Receptacle and Cable Assembly

a. Removal.

- (1) Unscrew the lockwasher bolt in the starter support from the support and the commutator end head assembly and remove the bolt, two internal- and external-teeth lock-

washers, and the ground cable. (If the auxiliary power receptacle is not to be installed, insert the $\frac{3}{8}$ -inch lockwasher bolt through the support and screw into the commutator end head.)

- (2) Unscrew the nut from the starter terminal. Remove the lockwasher and cable from the terminal. (If the auxiliary power receptacle is not to be installed, place the $\frac{5}{16}$ -inch lockwasher over the terminal and screw on the $\frac{5}{16}$ -inch nut.)
- (3) Remove the screw, nut, lockwasher, and the two clips used to secure the two cables to the fender splash apron.
- (4) Remove the four lockwasher screws holding the auxiliary power receptacle to the mounting bracket and remove the receptacle.
- (5) Remove the four lockwasher screws and nuts holding the bracket to the fender and remove the bracket.

b. Installation.

- (1) Position the auxiliary power receptacle mounting bracket on the top of the right front fender and align the holes in the bracket with the four holes in the fender. Push the four No. 12 x $\frac{5}{8}$ lockwasher screws through the holes in the bracket and the fender and screw a No. 12 nut on each bolt.
- (2) Push the two cables of the auxiliary power receptacle through the hole in the mounting bracket from the outside. Position the receptacle on the bracket, align the holes in the receptacle with the holes in the bracket, and install the four No. 12 x $\frac{5}{8}$ lockwasher screws.
- (3) (If the auxiliary power receptacle was not removed from the vehicle, remove the lockwasher bolt from the starter support and commutator end head assembly, and the nut from the starter terminal.) Install a $\frac{3}{8}$ -inch internal- and external-teeth lockwasher, and ground cable, and a second $\frac{3}{8}$ -inch internal- and external-teeth lockwasher over the $\frac{3}{8}$ x $\frac{7}{8}$ lockwasher bolt, and install the bolt through the support and into the commutator end head. Install the auxiliary power receptacle cable on the starter terminal and install the $\frac{5}{16}$ -inch lockwasher and nut.
- (4) Install a No. 10 x $\frac{1}{2}$ screw through the hole in the two $\frac{5}{8}$ -inch clips. Position the clips over the two cables, push the screw through the hole in the splash apron, and install a No. 10 lockwasher and nut on the screw.

Section XII. GENERATING SYSTEM

151. Description and Data

a. Description.

- (1) *General.* The generating system (fig. 65) consists of the generator assembly, generator regulator assembly, batteries, and connecting cables. The system is sealed and waterproof. It is a 24-volt, single-wire system, designed to automatically increase or decrease the charging rate to keep the battery fully charged without overcharging.

Note. The batteries are necessarily a part of the various electrical systems. The operations on batteries are included in paragraphs 154 through 164.

- (2) *Generator assembly.* The generator assembly (Z, fig. 66) is a 25-ampere, 24-volt, constant-duty-type, sealed, and waterproof. It is located at the right side of the engine and is driven from the crankshaft by a matched pair of V-belts. The mounting support (R, fig. 66) permits adjustment of the drive belts. All external electrical connections are made by a single waterproof wiring harness receptacle assembly.
- (3) *Generator regulator assembly.* The generator regulator assembly consists of three units: the voltage regulator, which controls the generator output voltage to prevent overcharging the batteries; the current regulator, which prevents overloading the generator; and the circuit breaker, which opens to prevent discharging the batteries when the generator output falls below the level required to charge the batteries. The regulator assembly is a waterproof unit.

b. Data.

Generator assembly:

Manufacturer	Electric Auto-Lite Co
Voltage	24
Polarity	negative ground
Controlled output	25 amp

Generator regulator assembly:

Manufacturer	Electric Auto-Lite Co
Voltage	24
Polarity	negative ground
Amperes	25

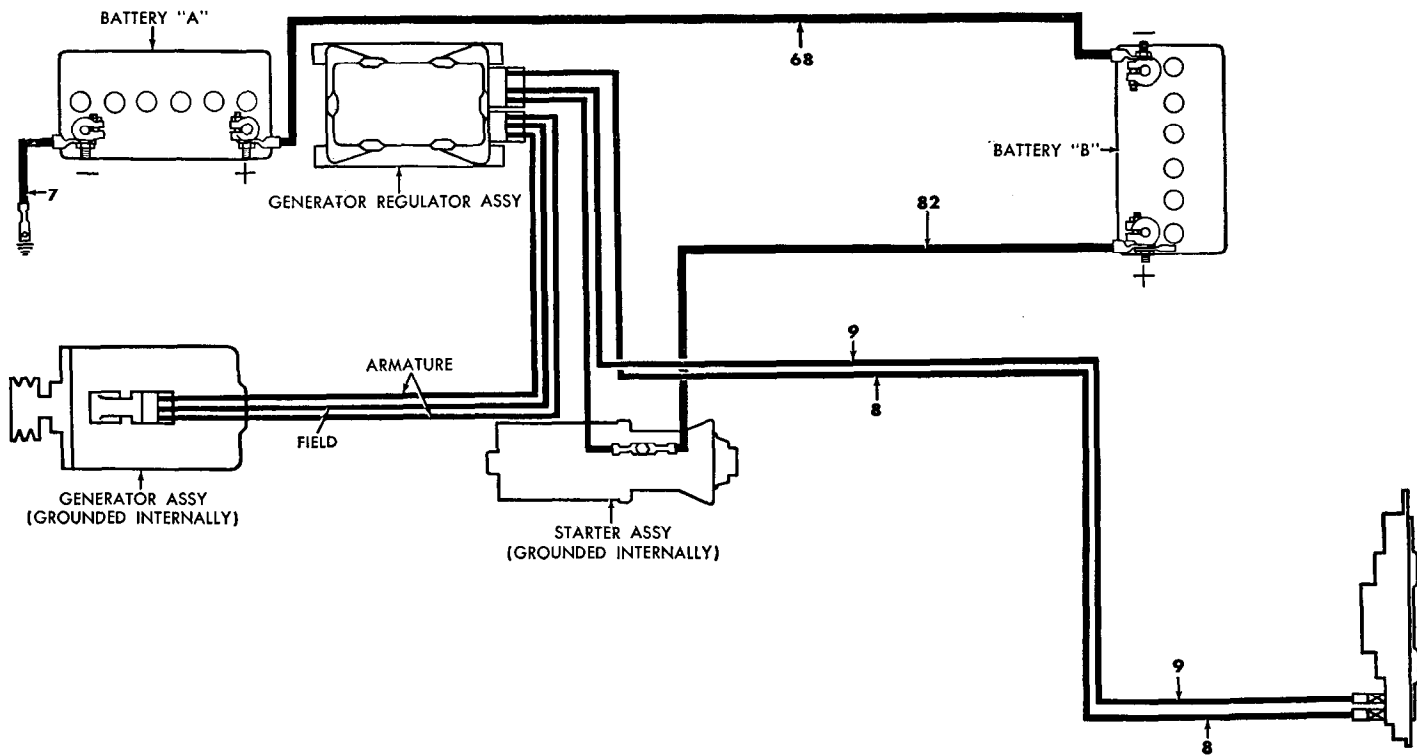

Figure 65. Generating system circuit.

152. Generator Assembly

(fig. 66)

a. Removal. Remove the wiring harness (A) by unscrewing the nut on the connector (B) securing the wiring harness to the wiring harness receptacle assembly (C) with a spanner wrench. Remove the lockwasher screw (D) and flat washer (E) securing the belt tension brace (G) to the drive end head (H) of the generator assembly. Swing the generator assembly (Z) toward the engine as far as it will go and remove both drive belts (F) from the generator pulley.

Note. Flat washers (L, P, T, and V) may drop when bolts (Q and S) are removed. Recover or remove the flat washers after removing the generator assembly.

Remove nut (J), lockwashers (K), bolt (Q), and flat washer (P) securing the drive end head (H) of the generator assembly to the engine front mounting support assembly (N). Remove the nut (X), lockwasher (W), bolt (S), and flat washer (T) securing the commutator end head (Y) of the generator assembly to the mounting support (R). Remove the generator assembly (Z) by lifting straight up until it clears the brace insulators (M and U) and lifting the commutator end up and out between the battery box and the air cleaner assembly. Examine both brace insulators in the mounting support (R). Do not remove unless damaged or deteriorated.

b. Installation. Lower the generator assembly (Z), drive end first, between the battery box and the air cleaner assembly, and work generator forward into position over the mounting support (R). Aided by a helper working underneath the vehicle, start the $\frac{7}{16} \times 2\frac{1}{4}$ bolt (S) and $1\frac{7}{32}$ -inch ID flat washer (T) through the brace insulator (U). Place the $1\frac{5}{32}$ -inch ID flat washer (V) between the brace insulator and the commutator end head (Y) of the generator and push the bolt (S) through the flat washer (V) and the commutator end head (Y). Place $\frac{7}{16}$ -inch lockwasher (W) over the end of the bolt (S) and install the $\frac{7}{16}$ -inch nut (X) but do not tighten. Have the helper start the $\frac{7}{16} \times 2\frac{1}{4}$ bolt (Q) and $1\frac{7}{32}$ -inch ID flat washer (P) through the brace insulator (M). Place the $1\frac{5}{32}$ -inch ID flat washer (L) between the brace insulator (M) and the drive end head (H) of the generator and push the bolt through the flat washer and drive end head. Place the $\frac{7}{16}$ -inch lockwasher (K) over end of the bolt and install the $\frac{7}{16}$ -inch nut (J) but do not tighten. Position the drive belts (F) over the drive pulley and pull the generator away from the engine until the drive belts are snug in place in all pulleys. Place $\frac{3}{8}$ -inch flat washer (E) over the $\frac{3}{8} \times 1$ lockwasher screw

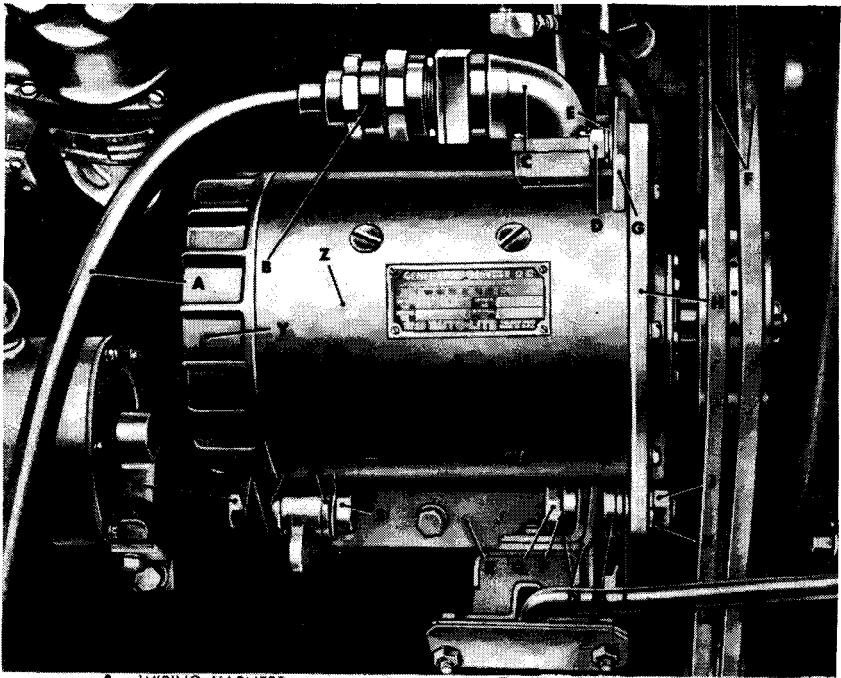

- | | |
|--|--------------------------------|
| A — WIRING HARNESS | P — FLAT WASHER |
| B — CONNECTOR | Q — BOLT |
| C — WIRING HARNESS RECEPTACLE
ASSY | R — MOUNTING SUPPORT |
| D — LOCK WASHER SCREW | S — BOLT |
| E — FLAT WASHER | T — FLAT WASHER |
| F — DRIVE BELT | U — BRACE INSULATOR |
| G — BELT TENSION BRACE | V — FLAT WASHER |
| H — DRIVE END HEAD | W — LOCK WASHER |
| J — NUT | X — NUT |
| K — LOCK WASHER | Y — COMMUTATOR END HEAD |
| L — FLAT WASHER | Z — GENERATOR ASSY |
| M — BRACE INSULATOR | |
| N — ENGINE FRONT MOUNTING
SUPPORT ASSY | |

RA PD 181562

Figure 66. Generator assembly—installed.

(D) and insert through the belt tension brace (G) and into the drive end head (H) of the generator assembly. Start bolt into threads but do not tighten. Adjust belt tension (par. 123). Tighten nut (J) and bolt (Q) securing the drive end head (H) of the generator to the engine front mounting support assembly (N). Tighten the nut (X) and bolt (S) securing the commutator end head (Y) of the generator to the mounting support (R). Position the wiring harness (A) in the wiring harness receptacle assembly (C) by aligning the slot in the connector (B) with the pin in the receptacle. Push the connector in as far as possible and screw the nut of the connector onto the receptacle with a spanner wrench.

153. Generator Regulator Assembly

(fig. 67)

Caution: Disconnect battery ground cable (par. 155c(2)) before attempting any work on the generator regulator assembly. See warning on top of regulator cover.

a. *Removal.* Use a spanner wrench to unscrew the two cable connector coupling nuts, and pull the cables from the receptacles. Remove four nuts and lockwashers securing the generator regulator assembly to the mounting bracket cushions, and remove the regulator.

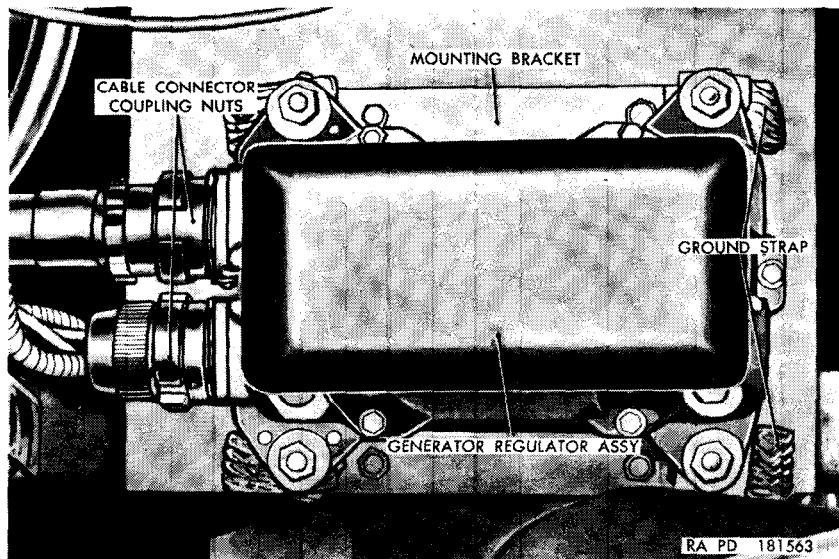

Figure 67. Generator regulator assembly—installed.

b. *Installation.* Place the generator regulator assembly in position over the studs of the mounting bracket cushions, with the cable receptacles to the rear. Install four $\frac{5}{16}$ -inch lockwashers and nuts securing the regulator. Push the cable connector plugs into their receptacles, being careful to enter the keys on the plugs into the slots in the receptacles. Install the cable connector coupling nuts and tighten with spanner wrench.

Section XIII. BATTERIES AND LIGHTING SYSTEM

154. Description and Data

a. Description.

- (1) *General.* Lighting system current is furnished by two 12-volt batteries connected in series to supply 24 volts

to all units. All units and connecting cables are sealed and waterproof. Cables are connected to the various units with bayonet-type connectors, joined together by interlocking sleeves or threaded couplings. All lighting circuits are controlled by the light switch (E, fig. 7) on the instrument panel. Starting, lighting, and ignition circuits are protected by the three circuit breakers located in the passenger compartment on the rear of the instrument panel.

- (2) *Batteries*. One battery is located in the right side of the cowl (fig. 69) and is accessible through a door on the top of the cowl. The other battery is located in the right side of the engine compartment (fig. 68). Terminals are waterproofed by applying a thick coating of artillery and automotive grease (GAA) after installation.
- (3) *Headlights* (fig. 70). The headlights are adjustable sealed lamp-units located on the front of the vehicle and controlled by switches in the passenger compartment.
- (4) *Blackout headlight* (fig. 74). The blackout headlight is an adjustable, sealed lamp-unit located on top of the left front fender. It is controlled by a switch in the passenger compartment.
- (5) *Blackout marker and service parking light* (fig. 76). A blackout marker and service parking light is located beneath each headlight. These lights are controlled by the light switch.
- (6) *Blackout taillight and stoplight assembly* (fig. 77). The blackout taillight and stoplight is mounted on the right rear corner of the body. The assembly includes a blackout stop lamp in the upper portion, and a blackout taillamp in the lower portion. The stop lamp is controlled by the stoplight switch. The taillamp is controlled by the light switch.
- (7) *Service taillight and stoplight assembly* (fig. 78). The service taillight and stoplight is mounted on the left rear corner of the body. The assembly includes a stop lamp and a service taillamp in the upper portion, and a blackout taillamp in the lower portion. The stoplamp is controlled by the stoplight switch. The service taillamp and the blackout taillamp are controlled by the light switch.
- (8) *Trailer coupling connector receptacle assembly* (fig. 79). The trailer coupling connector receptacle assembly is located on the body rear panel, above the service taillight and stoplight. This receptacle receives the cables

supplying current to the trailer lights. Current to the receptacle is controlled by the light switch (E, fig. 7).

b. Battery Data.

Manufacturer	The Electric Auto-Lite Co
Model	2HH
Voltage	12
Plates per cell	11
Type	waterproof
Number of batteries used	2
How connected	series for 24 v

155. Batteries

a. General. For purposes of identifying the individual batteries in the procedures given in this paragraph, the battery located in the engine compartment is identified as battery "A" (fig. 68) and the battery located in the cowl is identified as battery "B" (fig. 69).

b. Battery Maintenance. Refer to TM 9-2857 for specific gravity test, adding water, and cleaning.

c. Battery "A" Removal (fig. 68).

- (1) Lift and release the ring latches securing the insulating box cover and open the cover.
- (2) Remove the terminal nut and disconnect the ground cable from the clamp-type terminal on the negative post.
- (3) Remove the terminal nut and disconnect the battery-to-battery cable from the clamp-type terminal on the positive post.
- (4) Remove the two wing nuts and flat washers securing the hold-down frame to the battery, and the wing nuts and flat washers securing the battery box-to-fender straps to the battery box and hold-down frame. Remove the box-to-fender strap bolts and remove the hold-down frame.
- (5) Lift the battery straight up and out of the battery box.

Note. Do not use a lifting strap that fastens to the battery posts as it may result in damage to the battery.

d. Battery "A" Installation (fig. 68).

- (1) Lower the battery into the battery box, with the battery posts toward the engine side of the box.

Note. Replacement batteries may not be equipped with clamp-type terminals. If not, remove the terminals from the old battery and install on the replacement battery. Be sure that battery posts and terminals are clean.

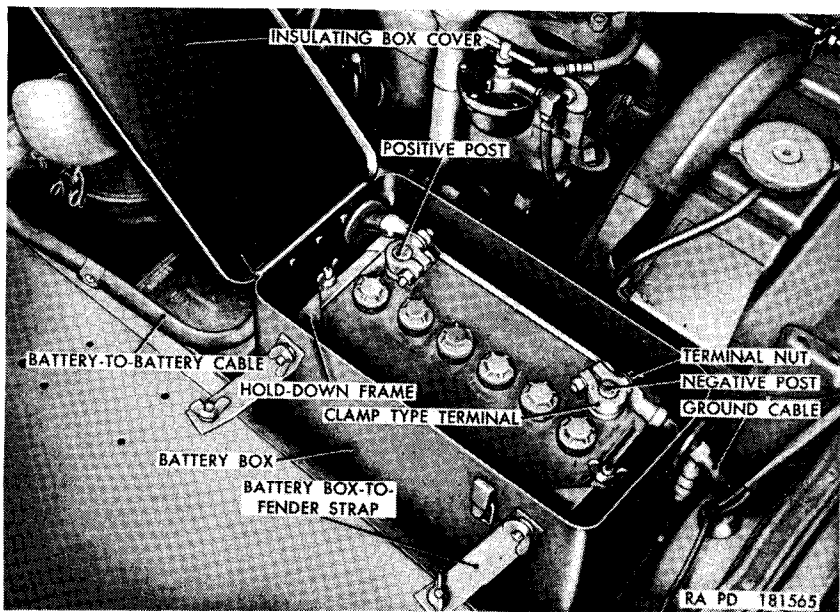

Figure 68. Battery "A" located in engine compartment.

- (2) Install the hold-down frame and install the two $\frac{5}{16}$ x $\frac{3}{4}$ bolts through the hold-down frame, the battery box, and the battery box-to-fender strap. Secure the hold-down frame and box-to-fender straps with four $\frac{5}{16}$ -inch plain washers and $\frac{5}{16}$ -inch wing nuts.
 - (3) Connect the battery-to-battery cable to the clamp-type terminal on the positive post, and secure with a $\frac{3}{8}$ -inch terminal nut.
 - (4) Connect the ground cable to the clamp-type terminal on the negative post, and secure with a $\frac{3}{8}$ -inch terminal nut.
 - (5) Check polarity (*g* below).
 - (6) Close the insulating box cover and secure with the ring latches.
- e. Battery "B" Removal (fig. 69).
- (1) Open battery "A" insulating box cover (*c*(1) above).
 - (2) Disconnect the ground cable from battery "A" (*c*(2) above).
 - (3) Turn the wing nuts securing the battery box door one-quarter turn and open the door.
 - (4) Remove the terminal nut and disconnect the battery-to-battery cable from the clamp-type terminal on the negative post.

- (5) Remove the terminal nut and disconnect the battery-to-starter cable from the clamp-type terminal on the positive post.
- (6) Remove two wing nuts securing the hold-down frame and remove the frame.
- (7) Remove the battery (c(5) above).

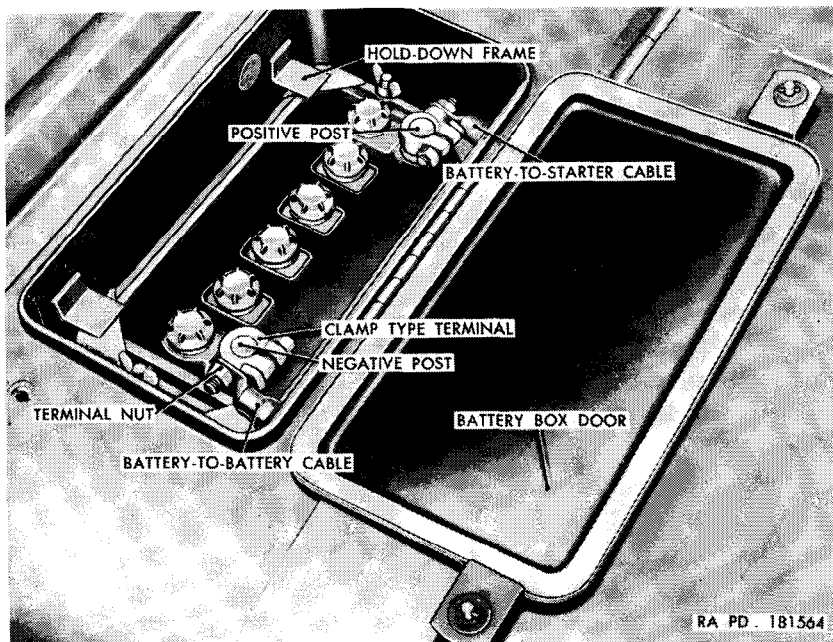

Figure 69. Battery "B" located in cowl.

f. Battery "B" Installation (fig. 69).

- (1) Lower the battery into the cowl (see Note in *d*(1) above).
- (2) Install the hold-down frame and secure with two $\frac{5}{16}$ -inch wing nuts.
- (3) Connect the battery-to-starter cable to the clamp-type terminal on the positive post and secure with a $\frac{3}{8}$ -inch terminal nut.
- (4) Connect the battery-to-battery cable to the clamp-type terminal on the negative post and secure with a $\frac{3}{8}$ -inch terminal nut.
- (5) Close the battery box door and secure by turning the wing nuts one-quarter turn.
- (6) Connect the ground cable to battery "A" (*d*(4) above).
- (7) Check polarity (*g* below).

- (8) Close the battery "A" insulating cover and secure with the ring latches.

g. Check Polarity. Check polarity by turning on headlights. If they light, and the ammeter shows discharge, the polarity is correct. If headlights do not light and ammeter shows no appreciable reading, one battery is reversed. If headlights light and ammeter shows charge, both batteries are reversed. Correct installation as necessary.

156. Battery Cables

(figs. 68 and 69)

a. Battery "A" Ground Cable (No. 7) Removal.

- (1) Open the insulating box cover (par. 155c(1)).
- (2) Disconnect the ground cable (par. 155c(2)).
- (3) Remove the nut, bolt, and two lockwashers securing the other end of the ground cable to the battery box support and remove the cable.

b. Battery "A" Ground Cable (No. 7) Installation.

- (1) Install a $\frac{3}{8}$ -inch internal-external tooth lockwasher over a $\frac{3}{8} \times \frac{7}{8}$ bolt. Position the ground cable terminal over the hole in the battery box support and insert the bolt with lockwasher through the terminal and support. Secure with a $\frac{3}{8}$ -inch lockwasher and nut.
- (2) Insert the other end of the cable through the rubber grommet in the insulating box.
- (3) Connect the ground cable to the battery (par. 155d(4)).
- (4) Close and secure the insulating box cover (par. 155d(6)).

c. Battery-to-Battery Cable (No. 68) Removal.

- (1) Open battery "A" insulating box cover (par. 155c(1)).
- (2) Disconnect the ground cable at battery "A" (par. 155c(2)).
- (3) Disconnect the battery-to-battery cable at battery "A" (par. 155c(3)).
- (4) Open battery "B" box door (par. 155e(3)).
- (5) Disconnect the battery-to-battery cable at battery "B" (par. 155e(4)).
- (6) Remove the nut, lockwasher, and bolt securing the battery-to-battery cable closed clip to the fender splash shield and remove the cable.

d. Battery-to-Battery Cable (No. 68) Installation.

- (1) Install the battery-to-battery cable closed clip over the cable and secure to the fender splash shield with a No. 10 $\times \frac{5}{8}$ bolt, lockwasher, and nut.

- (2) Position the battery-to-battery cable through the holes in the battery boxes, being sure that the rubber grommets are in place.
 - (3) Connect the cable at battery "A" (par. 155d(3)).
 - (4) Connect the cable at battery "B" (par. 155f(4)).
 - (5) Connect the ground cable to battery "A" (par. 155d(4)).
 - (6) Close both battery boxes (par. 155d(6) and f(8)).
- e. *Battery-to-Starter Cable (No. 82) Removal.*
- (1) Open both battery boxes and disconnect the ground cable at battery "A" (par. 155c(2)).
 - (2) Disconnect the battery-to-starter cable at battery "B" (par. 155e(5)).
 - (3) Remove the nut and lockwasher securing the other end of the cable to its terminal on the starter switch (fig. 64) and remove the cable.
- f. *Battery-to-Starter Cable (No. 82) Installation.*
- (1) Install one end of the battery-to-starter cable on its terminal at the starter switch (fig. 62) and secure with a $\frac{3}{8}$ -inch lockwasher and nut.
 - (2) Insert the other end of the cable through the rubber grommets in the cowl and battery "B" box.
 - (3) Connect the cable at battery "B" (par. 155f(3)).
 - (4) Connect the ground cable at battery "A" (par. 155d(4)).
 - (5) Close both battery boxes (par. 155d(6) and f(8)).

157. Headlights

a. *Headlight Sealed Lamp-Unit (fig. 70).*

- (1) *Removal.* Remove two lockwasher screws securing the headlight guard to the radiator guard. Unscrew three screws securing the door assembly to the housing assembly and remove the door and door gasket. The screws are fastened in the door to prevent loss. Loosen the three screws securing the lamp-unit retaining ring to the housing assembly, and remove the retaining ring by turning counterclockwise. Pull the sealed lamp-unit from the housing. Pull the three cable connectors from the clips in the housing, and disconnect the cables at the connectors. Remove the sealed lamp-unit.
- (2) *Installation.* Connect cable Nos. 17, 18, and 91 on the sealed lamp-unit to cable Nos. 17, 18, and 91 at the connectors in the housing assembly and clip the connectors in the housing. Place the sealed lamp-unit in the housing with the projections on the edge of the lamp-unit in the notches in the rim of the housing. Place

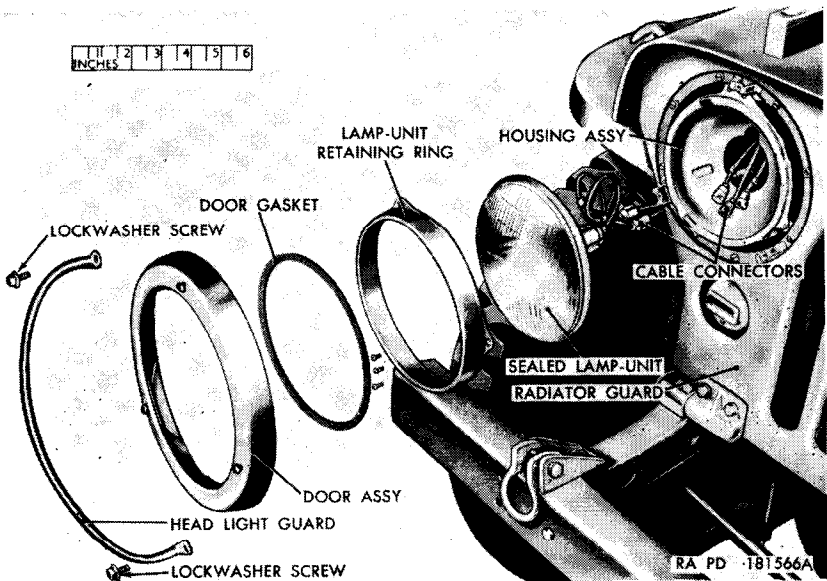

Figure 70. Headlight—partially exploded view.

the lamp-unit retaining rim over the lamp-unit and under the heads of the three screws in the housing. Turn the ring clockwise and tighten the screws. Be certain that the door gasket is in place in the door assembly. If gasket was damaged during removal, use a new gasket. Place the door assembly against the housing. Start the three screws securing the door assembly to the housing assembly. Draw the screws up gradually and evenly until the door assembly is seated against the housing. Place the headlight guard in position and secure it with two $\frac{1}{4} \times \frac{5}{8}$ lockwasher screws.

b. Headlight Adjustment. Place the vehicle on a level surface and arrange a wall target as shown in figure 71. Remove the headlight guard and door assembly (a(1) above). Cover headlight not being adjusted. Turn on the headlights (par. 33) and be sure that the high beam is on (par. 40). Aim the headlight by turning the adjustment screws (fig. 72), as required, until the headlight beam conforms with the headlight beam pattern (fig. 73). Turn off the headlights. Install the door and guard (b(2) above).

c. Headlight Assembly Removal. The removal procedure is the same for both headlights.

(1) Remove the headlight sealed lamp-unit (a(1) above).

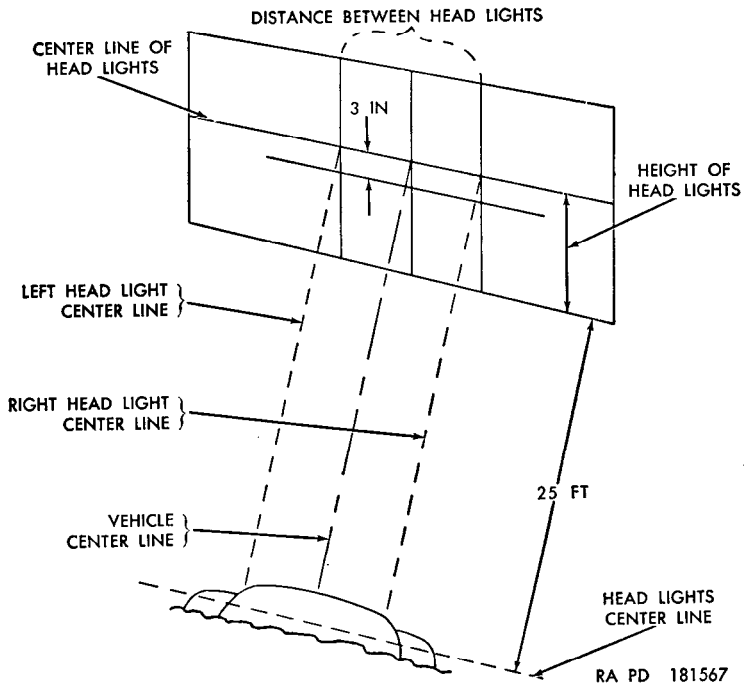

Figure 71. Headlight aiming chart.

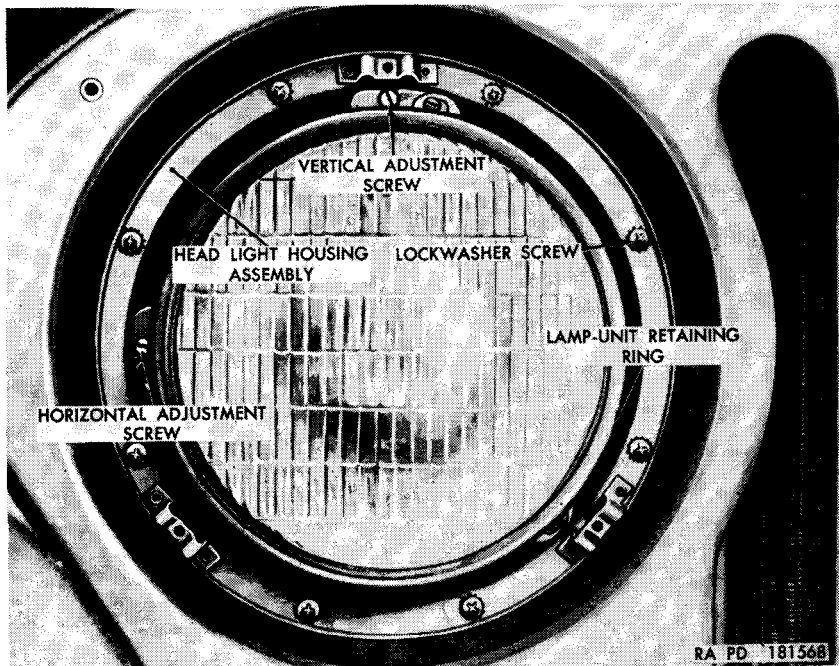

Figure 72. Headlight adjustment screws.

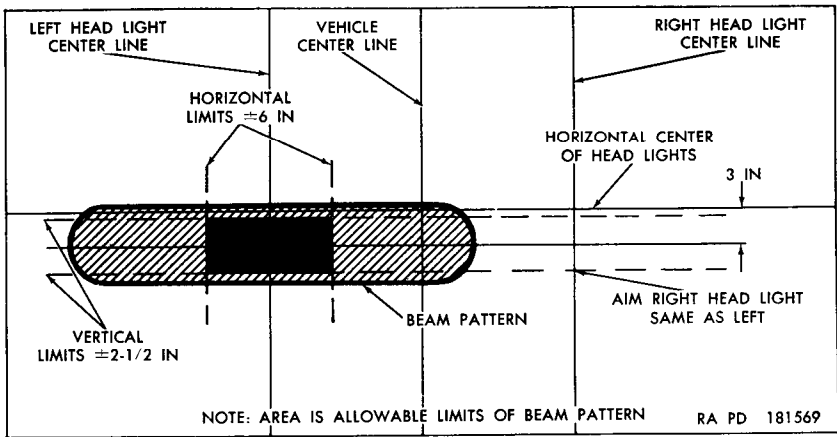

Figure 73. Headlight beam pattern.

- (2) Remove the rubber grommet from the top of the headlight housing.
- (3) Remove the headlight cables from the headlight housing.
- (4) Remove eight lockwasher screws securing the headlight housing to the radiator grille.
- (5) Remove headlight housing and mounting pad.

d. Headlight Assembly Installation. The installation procedure is the same for both headlights.

- (1) Position the mounting pad on the rear of the headlight housing with the mounting holes in the pad alined with those in the housing.
- (2) Position the housing with mounting pad in the radiator grille and secure with eight No. 10 x 1/2 lockwasher screws (fig. 78).
- (3) Slip the rubber grommet over the headlight cables, and insert cables and grommet in headlight housing.
- (4) Install the headlight sealed lamp-unit (a(2) above).

158. Blackout Headlight Assembly

a. Blackout Headlight Sealed Lamp-Unit (fig. 74).

- (1) *Removal.* Unscrew three screws securing the door assembly to the housing assembly, and pull the door and sealed lamp-unit from the housing assembly. Pull the cable connectors from the clips in the housing assembly and disconnect both cables. Remove three retaining springs securing the sealed lamp-unit in the door assembly and remove the unit.

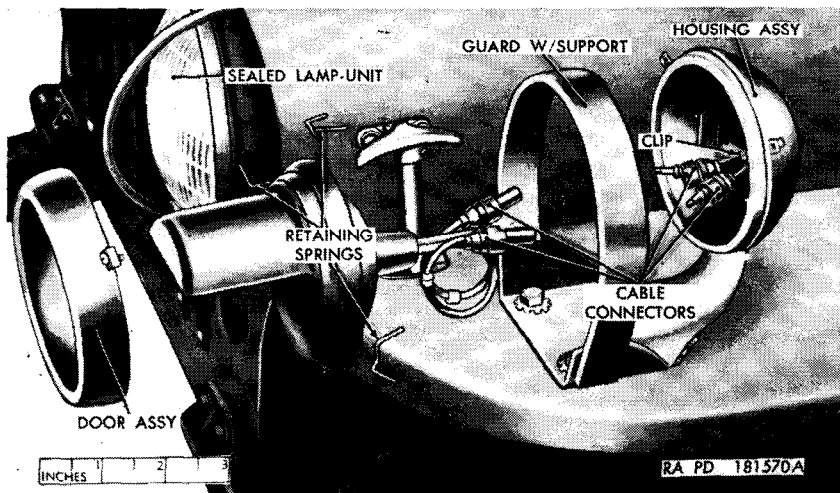

Figure 74. Blackout headlight assembly—partially exploded view.

- (2) *Installation.* Place the sealed lamp-unit in the door assembly, with the pad on the edge of the lamp-unit in the notch in the door assembly, and secure with three retaining springs. Place the door and lamp-unit in front of the guard with support, and fasten the connectors on the lamp-unit cables to the connectors inside the housing assembly. Place the connectors in the clips inside the housing. Position the door and lamp-unit on the housing assembly and secure the door assembly to the housing assembly with three No. 8 x $\frac{3}{8}$ screws, which are retained in the door.

b. Blackout Headlight Assembly (fig. 75).

(1) *Removal.*

Note. Three bolts, lockwashers, and nuts secure the cable clips and ground terminal to the fender. The bolts are installed from the top and the nuts are under the fender.

Remove the bolt, nut, and lockwasher securing the horn and ground cables to the fender splash shield. Remove two bolts, nuts, and lockwashers securing the cable clips to the fender. Disconnect cable No. 91 at the connector adjacent to the ground cable terminal. Remove the nut, lockwasher, and bearing washer securing the light assembly to the guard with support, and remove the light assembly.

- (2) *Installation.* Place the light assembly on the guard with support, with the stud on the housing through the hole in the support, and install the bearing washer (convex

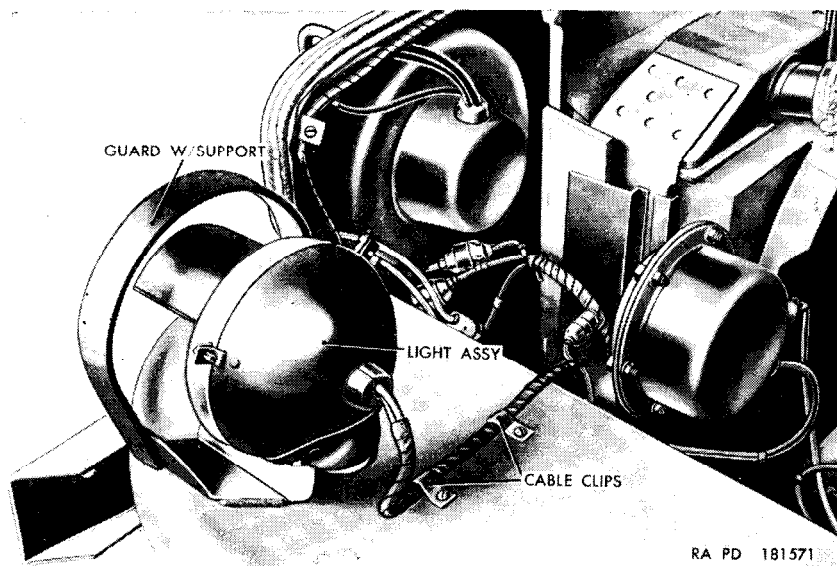

RA PD 181571

Figure 75. Blackout headlight assembly—installed.

side up), lockwasher, and nut. Point the light straight-ahead and tighten the nut. Insert one No. 10 x $\frac{1}{2}$ bolt through each cable clip and the holes in the fender. Install a lockwasher and nut on each bolt from beneath the fender. Secure the terminal on cable No. 91, together with the horn ground cable, to the fender splash shield with one No. 10 x $\frac{1}{2}$ bolt, lockwasher, and nut.

159. Blackout Marker and Service Parking Lights (Front) (fig. 76)

Note. Instructions in *a* and *b* below apply to both right and left lights.

a. Lamp Removal. Remove two screws securing the door with lens assembly and gasket to the housing assembly and remove. Push the lamp in, turn counterclockwise, and remove.

Note. Gasket should stay in the door assembly.

b. Lamp Installation. Insert the new lamp into the socket and turn clockwise to lock in place. Examine the gasket in the door with lens assembly. If damaged, replace. Place the door against the housing assembly and secure with two No. 8 x $\frac{1}{2}$ screws.

c. Blackout Marker and Service Parking Light Assembly Removal. The removal procedure is the same for both blackout marker and service parking lights.

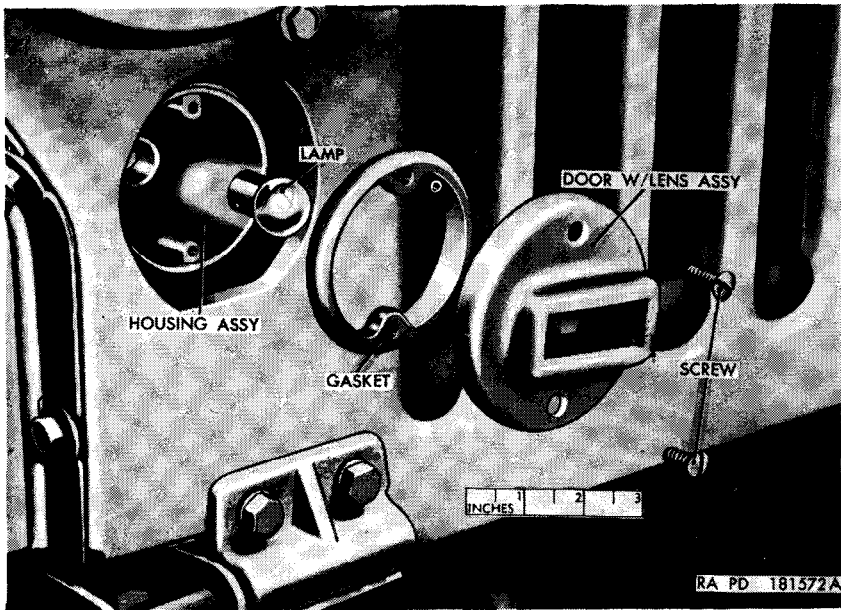

Figure 76. Blackout marker and service parking light assembly—partially exploded view.

- (1) Disconnect cable No. 20 from the wiring harness clipped to the side of the radiator grille.
- (2) Remove the lockwasher nut securing the light to the mounting bracket on the radiator guard and remove the light and mounting pad.

d. Blackout Marker and Service Parking Light Assembly Installation. The installation procedure is the same for both blackout marker and service parking lights.

- (1) Position the mounting pad on the mounting stud of the assembly.
- (2) Insert the stud through the hole in the mounting bracket on the radiator guard and secure the light assembly with a $\frac{5}{16}$ -inch lockwasher nut.
- (3) Connect cable No. 20 to the wiring harness.

160. Taillight, Stop, and Blackout Lights

a. Blackout Taillight and Stoptlight Assembly (Right) (fig. 77).

- (1) *Lamp replacement.* Unscrew the six screws securing the door with lens and screws assembly to the housing assembly and remove the door and gasket. Push defective lamp in and turn counterclockwise to remove. Insert the new lamp and turn clockwise to lock in place. Examine

the gasket and replace if necessary. Position the door with lens and screws assembly against the housing assembly and start the six No. 10 x 1 $\frac{1}{32}$ screws. Tighten the screws evenly.

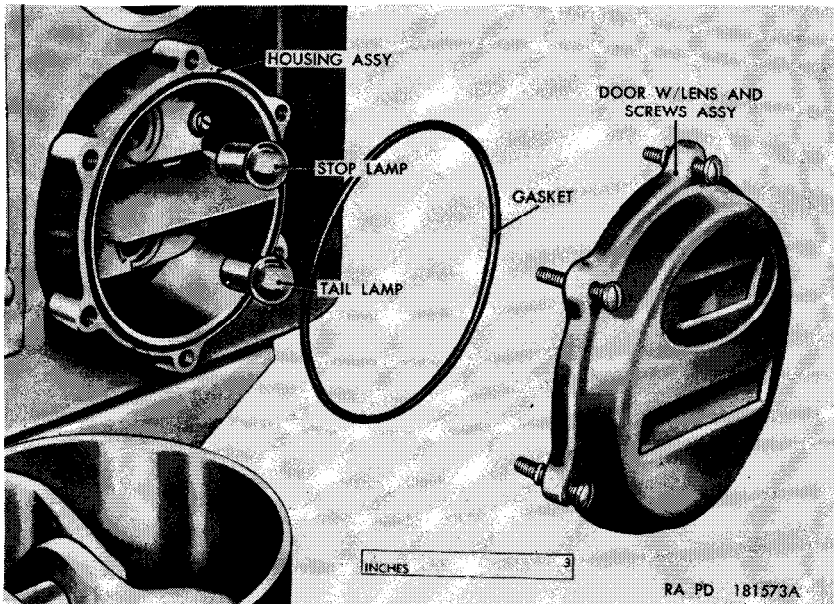

Figure 77. Blackout taillight and stoplight assembly—partially exploded view.

- (2) *Removal.* Remove two cables from the clip on the back of the housing assembly, pull the cables out until the cable connectors are exposed, and uncouple both connectors. Remove two bolts and lockwashers securing the blackout taillight and stoplight assembly and remove the assembly.
 - (3) *Installation.* Insert the connectors through the hole in the blackout taillight and stoplight assembly mounting bracket, position the assembly on the bracket, and secure with two $\frac{3}{8}$ x $\frac{5}{8}$ bolts and lockwashers. Couple the connectors in accordance with the cable numbers.
- b. *Service Taillight and Stoplight Assembly (Left) (fig. 78).*
- (1) *Lamp replacement.* Refer to a(1) above.
 - (2) *Removal.* Remove two lockwasher screws securing the taillight and trailer connection guard to the body left rear panel. These screws are located near the left rear corner of the body, one screw below the reflector and one above the reflector. Remove two lockwasher screws securing the guard to the body side panel. These screws

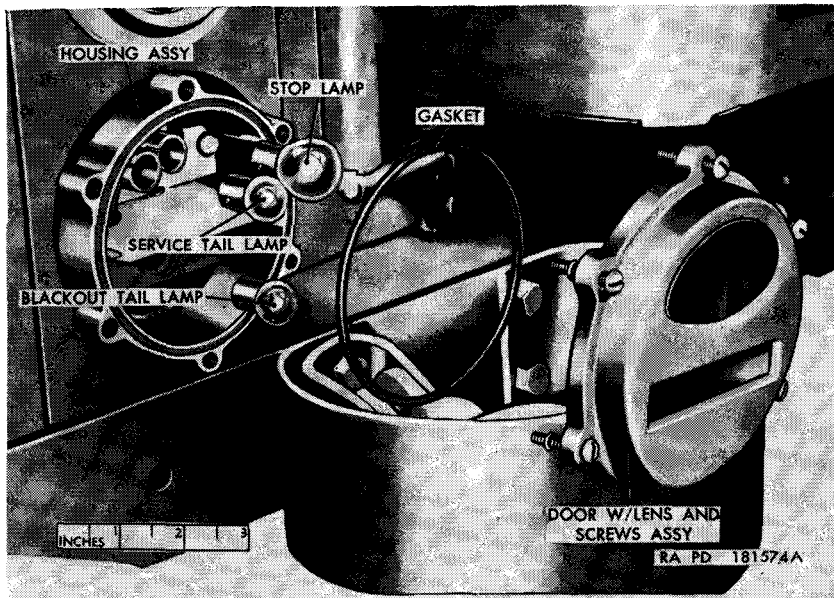

Figure 78. Service taillight and stoplight assembly—partially exploded view.

are located adjacent to the left edge of the rear seat in the passenger compartment. Remove the guard from the left rear wheel housing. Disconnect the three taillight and stoplight cable connectors (fig. 79). Remove two bolts and lockwashers securing the service taillight and stoplight assembly to the service taillight and stoplight bracket and remove the assembly.

- (3) *Installation.* Place the service taillight and stoplight assembly in position on the service taillight and stoplight bracket and secure with two $\frac{3}{8}$ x $\frac{5}{8}$ bolts and lockwashers. Connect the taillight and stoplight cable connectors in accordance with the numbers on the cables. Place the taillight and trailer connection guard in position inside the left rear wheel housing. Start the two $\frac{1}{4}$ x $\frac{5}{8}$ lockwasher screws through the body left rear panel and into the guard. Start the two $\frac{1}{4}$ x $\frac{5}{8}$ lockwasher screws through the body side panel and into the guard. Tighten all four screws.

161. Instrument Panel Lights

Refer to paragraph 39 for description and location, and paragraph 165 for removal and installation of the instrument panel lights.

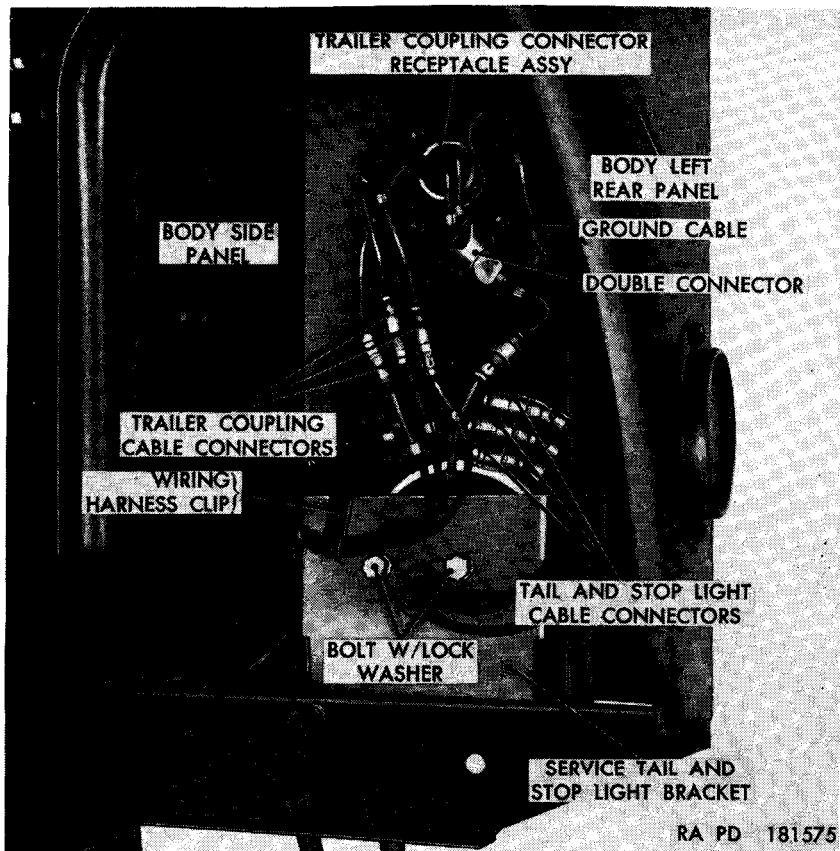

Figure 79. Taillight and trailer connection guard assembly removed to show trailer coupling, and taillight and service stoplight cable connectors.

162. Trailer Coupling Connector Receptacle Assembly (fig. 79)

a. Removal. Follow instructions in paragraph 160b(2) for removal of the taillight and trailer connection guard. Disconnect the three trailer coupling cable connectors and the double connector by pushing the halves of the connectors together and rotating them left hand. Remove the bolt, nut, and lockwasher securing the ground cable to the body rear panel. Remove four bolts and lockwashers securing the trailer coupling connector receptacle assembly to the body rear panel and remove the assembly and polarizing bracket (fig. 9). The receptacle cover and receptacle connector assemblies will separate after removal. Pull the cables through the body rear panel, one at a time, to avoid damaging the connectors.

b. Installation.

Note. If trouble is experienced with the receptacle cover striking and damaging reflex reflector when inter-vehicular cable is plugged into receptacle, rotate the entire receptacle and cover as a unit, 90° clockwise before installing.

Place the receptacle cover assembly on the receptacle connector assembly. Position the polarizing bracket (fig. 9) behind the receptacle with the longest prong of the bracket downward and directly opposite the hinge of the receptacle cover. Insert the connectors through the hole in the body rear panel and position the assembly against the panel, with the cover hinge at the top. Install four $\frac{1}{4}$ x $\frac{5}{8}$ bolts and lockwashers securing the assembly to the panel. Insert a No. 10 x $\frac{5}{8}$ bolt through the hole below the assembly, and place the ground cable terminal over the bolt, securing with a No. 10 lockwasher and nut. Push the two halves of the double connector together and turn right hand to lock. Place the two halves of each trailer coupling cable connector together, as numbered, and turn right hand to lock. Install the tail-light and trailer connection guard (par. 160*b*(3)).

163. Wiring Circuits and Cables

Table IV lists each circuit number in the electrical system and traces each circuit from source to end as shown on figure 80. A point-to-point check for circuit continuity can be made, using a standard low-voltage circuit tester equipped with long cables. Multiple contact connectors are used at the light switch, the voltage regulator and trailer electric receptacle. In these units the circuits are identified in both the plugs and sockets by letters moulded into the insulating material.

Table IV. Circuit Numbers and Descriptions

Circuit number	Circuit description
4	Voltage regulator output A terminal to starter
7	Battery to ground
8	Voltage regulator output B terminal to positive ammeter terminal
9	Voltage regulator output D terminal to negative ammeter terminal
10	Voltage regulator output C terminal to horn switch, ignition switch, and light switch connector
11	Ignition switch to light switch F terminal
12	Distributor and ignition coil to ignition switch
15	Generator regulator C terminal to light switch F terminal
16	Light switch M terminal to dimmer switch
17	Headlight to dimmer switch and high beam indicator
18	Headlight to dimmer switch

Circuit number	Circuit description
19	Light switch D terminal to blackout headlight
20	Light switch E terminal to blackout marker lights
21	Light switch H terminal to trailer coupling connector receptacle E terminal and left taillight
22	Light switch C terminal to trailer coupling connector receptacle B terminal and left taillight
23	Light switch N terminal to trailer coupling connector receptacle F terminal and right taillight
24	Light switch E terminal to trailer coupling connector receptacle A and C terminals and right and left taillights
25	Horn circuit from voltage regulator C terminal to horn switch, horn, and horn ground
27	Instrument panel to ignition switch
28	Fuel gage to fuel gage sending unit
33	Water temperature gage to water temperature gage sending unit
36	Oil pressure gage to oil pressure gage sending unit
40	Light switch B terminal to instrument cluster lights
68	Battery "B" positive terminal to battery "A" negative terminal
75	Light switch A and K terminal to stop light switch
82	Battery "A" to starter
85	Ignition switch to open connector
90	Trailer coupling connector receptacle to ground
91	Blackout driving light and headlights to ground

164. Headlight High Beam Indicator Light

Refer to paragraph 40 for description and location, and paragraph 179 for removal and installation of the headlight high beam indicator light.

Section XIV. WINCH ASSEMBLY

165. Description

a. Description. The horizontal drum-type winch assembly is mounted between the frame side members at the front of the vehicle as shown in figure 81. The winch is driven from the power-take-off (par. 202) on the rear of the transfer through a system of shafts and universal joints.

b. Operation and Data. The operation and data of the winch and power-take-off are discussed in paragraphs 54 and 55.

166. Coordination With Ordnance Maintenance Unit

Replacement of the winch assembly is normally an ordnance maintenance unit responsibility, but may be performed in an

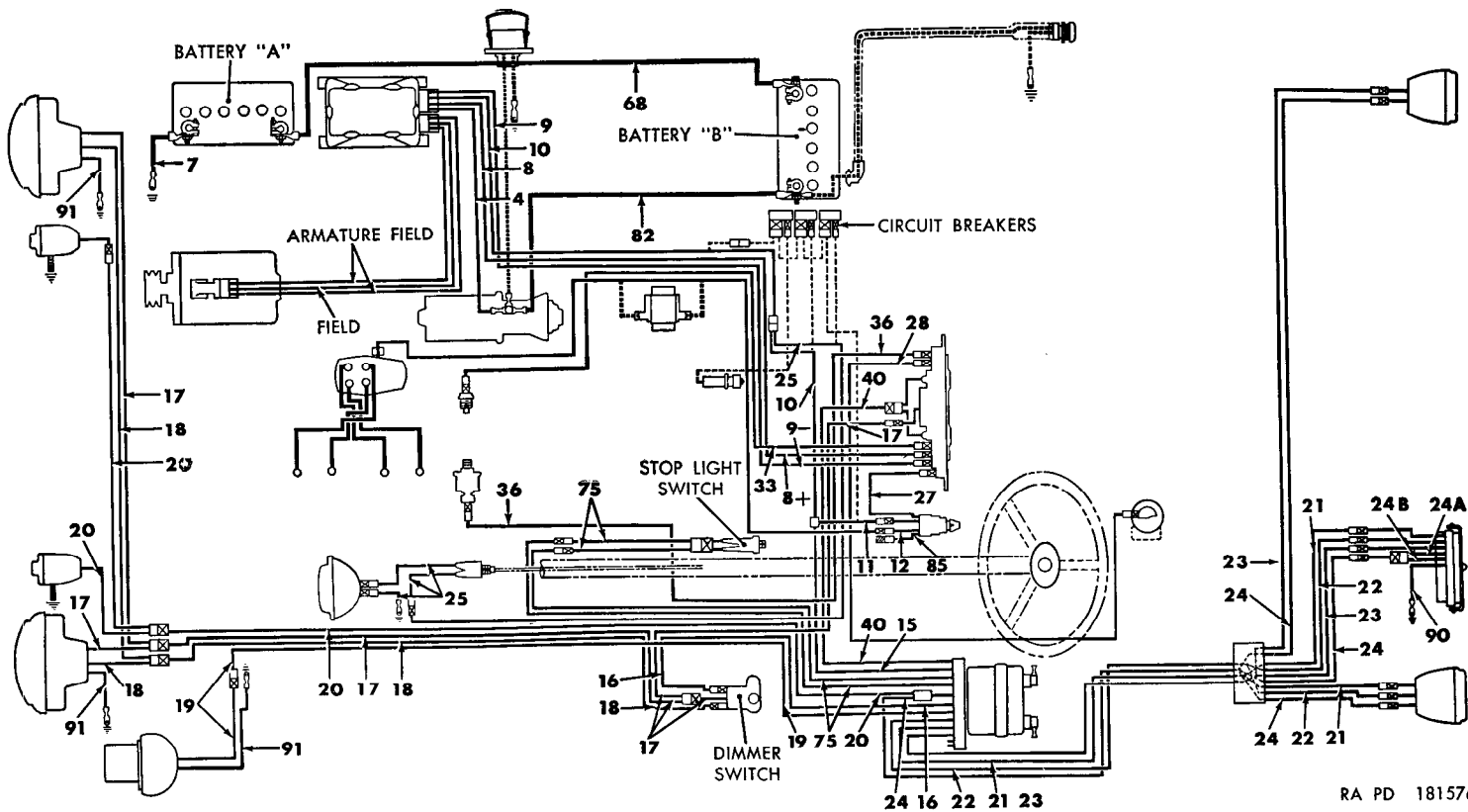

Figure 80. Vehicle wiring diagram and circuit identification.

RA PD 181576

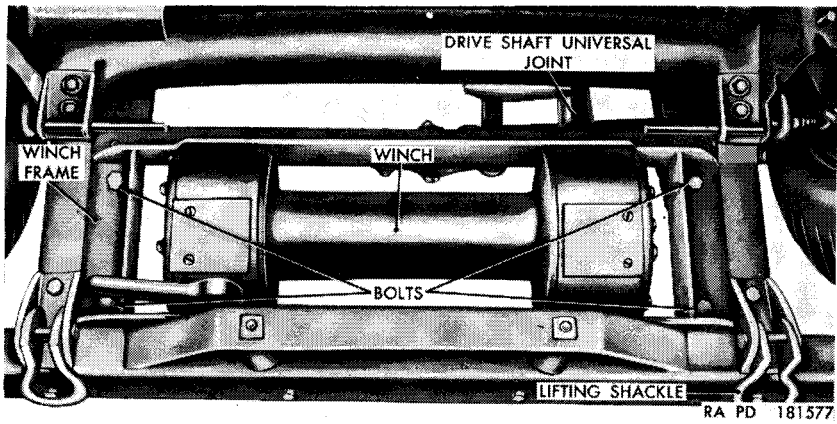

Figure 81. Winch installed.

emergency by the using organization, provided authority for performing this replacement is obtained from the supporting ordnance officer. Tools and equipment needed for this operation which are not carried by the using organization may be obtained from the supporting ordnance unit.

167. Organizational Maintenance

The using organization is responsible for the lubrication of the winch assembly as covered in paragraph 66.

168. Winch

Note. The key letters noted in parentheses are in figure 82, except where otherwise indicated.

a. Removal.

- (1) Loosen the setscrew (Z) securing the universal joint to the shaft of worm gear (A). Slide the long drive shaft (C) with universal joint toward the rear of the vehicle into the universal slip joint assembly (D) and off the shaft of worm gear and the key. Lower to floor.
- (2) Remove the four bolts (fig. 81) and lockwashers securing the winch frame to the frame support brackets, and raise the winch with frame up and out of the vehicle.

b. Installation.

- (1) Position the winch with the winch frame (fig. 81) on the frame support brackets and align the holes in the frame with the holes in the brackets. Place a $\frac{1}{2}$ -inch lockwasher over each of the four $\frac{1}{2}$ x 1 bolts. Insert the bolts with washers through the holes in the winch frame and screw into the frame support brackets.

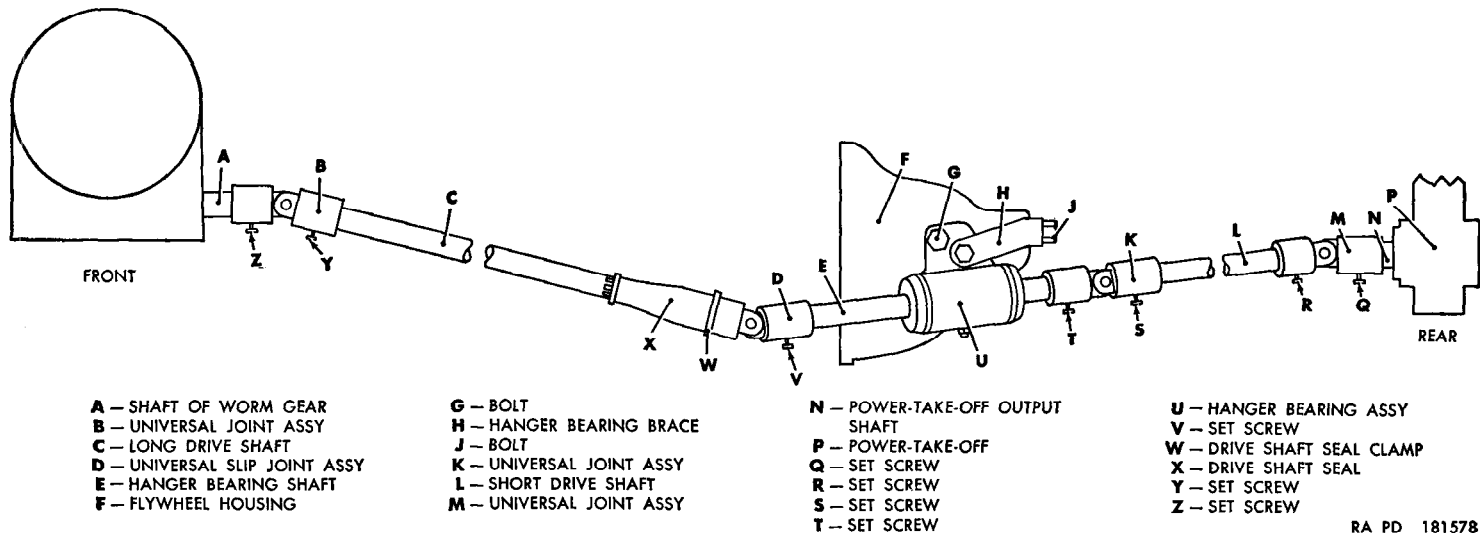

Figure 82. Winch drive shafts and universal joints.

RA PD 181578

- (2) Raise the long drive shaft (C) with universal joint and slide the drive shaft toward the rear of the vehicle and into the universal slip joint assembly (D). Aline the universal joint with the shaft of worm gear (A). Aline the keyway in the universal joint assembly (B) with the key in the shaft of worm gear. Slide the universal joint and drive shaft forward and onto the shaft of worm gear and the key, and tighten setscrew (Z).

c. Adjustment of Worm Brake. With the winch operating in the forward direction (drawing in cable), loosen the brake adjusting screw locknut, and turn the adjusting screw until it begins to tighten. Tighten the locknut.

169. Drive Shafts

(fig. 82)

a. Remove Long and Short Drive Shafts.

- (1) Remove the long drive shaft (C) with universal joint assemblies by loosening the setscrew (V) securing the universal slip joint assembly (D) to the front end of hanger bearing shaft (E). Loosen the setscrew (Z) securing the universal joint assembly (B) to the shaft of worm gear (A). Slide the shaft with universal joint toward the rear of the vehicle into the universal slip joint and off the shaft of worm gear and the key. Pull the universal slip joint off the front end of hanger bearing shaft and the key, and remove the drive shaft with universal joint assemblies from the vehicle.
- (2) Remove the universal joint assemblies (par. 170a(2) and (3)) if necessary.
- (3) To remove the short drive shaft (L) with universal joint assemblies, loosen the setscrew (T) securing the universal joint assembly (K) to the rear end of hanger bearing shaft (E) and loosen the setscrew (Q) securing the universal joint assembly (M) on the power-takeoff output shaft (N).
- (4) Unscrew the bolt (J) securing the hanger bearing brace (H) to the flywheel housing (F) and remove the bolt and lockwasher. Unscrew the bolt (G) securing the hanger bearing assembly (U) to the flywheel housing and remove the bolt and lockwasher. Slide the hanger bearing assembly with the short drive shaft (L) and universal joint assemblies toward the front of the vehicle on the splines of the long drive shaft (C) and off the power-take-off output shaft (N) and key. Pull the

short drive shaft with universal joint assemblies off the rear end of hanger bearing shaft (E) and key, and remove the shaft with the universal joint assemblies from the vehicle.

- (5) Remove the universal joint assemblies (par. 170b(2)) if necessary.

b. Install Long and Short Drive Shafts.

- (1) Install the universal joint assemblies on the long drive shaft (par. 170c(1) and (2)) if removed.
- (2) Aline the keyway in the universal slip joint assembly (D) with the key in the front end of hanger bearing shaft (E) and slide the universal slip joint onto the shaft and key. Aline the keyway in the universal joint assembly (B) with the key in the shaft of worm gear (A) and slide the universal joint onto the shaft and key. Tighten the setscrew (Z) securing the universal joint assembly (B) to the shaft of worm gear. Tighten the setscrew (V) securing the universal slip joint to the front end of hanger bearing shaft.
- (3) Install the universal joint assemblies on the short drive shaft (par. 170d(1)) if removed.
- (4) Aline the keyway in the universal joint assembly (M) with the key in the power-take-off output shaft (N) and slide the universal joint onto the shaft and key.
- (5) Slide the hanger bearing assembly (U) and universal slip joint assembly (D) onto the splines of the long drive shaft (C). Aline the keyway in the universal joint assembly (K) with the key in the rear end of hanger bearing shaft (E). Slide the rear end of hanger bearing shaft into the universal joint assembly (K).
- (6) Position the hanger bearing assembly (U) on the flywheel housing (F). Place a $\frac{9}{16}$ -inch lockwasher over the $\frac{9}{16} \times 1\frac{1}{2}$ bolt (G), insert the bolt with washer through the hole in the hanger bearing and screw the bolt into the flywheel housing. Place a $\frac{7}{16}$ -inch lockwasher over the $\frac{7}{16} \times 1\frac{1}{2}$ bolt (J), insert the bolt with washer through the hanger bearing brace (H), and screw the bolt into the flywheel housing.
- (7) Tighten the setscrew (Q) securing the universal joint assembly (M) to the power-take-off output shaft (N). Tighten the setscrew (T) securing the universal joint assembly (K) to the rear end of hanger bearing shaft (E).

170. Universal Joint Assemblies

(fig. 82)

a. Remove Universal Joint Assemblies (Long Drive Shaft).

- (1) Remove the long drive shaft with universal joint assemblies (par. 169a(1)).
- (2) Remove the universal joint assembly (B) by loosening the setscrew (Y) securing the joint to the shaft and pull the joint off the shaft and key.
- (3) Remove the universal slip joint assembly (D) by removing the drive shaft seal clamp (W) securing the drive shaft seal (X) to the joint and pull the joint off the splines of the shaft and out of the seal.

b. Remove Universal Joint Assemblies (Short Drive Shaft).

- (1) Remove the short drive shaft with the universal joint assemblies (par. 169a(3) and (4)).
- (2) Loosen the setscrews (R and S) securing the universal joint assemblies (K and M) to the shaft, and pull the joints off the shaft and keys.

c. Install Universal Joint Assemblies (Long Drive Shaft).

- (1) Line up the keyway in the universal joint assembly (B) with the key in the long drive shaft (C), and slide the joint onto the shaft and key.
- (2) Slide the splined end of the universal slip joint assembly (D) into the drive shaft seal (X) and onto the splined end of the long drive shaft.
- (3) Install the shaft with universal joint assemblies (par. 169b(2)).
- (4) Tighten the setscrew (Y) securing the universal joint assembly (B) to the shaft. Install the drive shaft seal clamp (W) securing the drive shaft seal (X) to the universal slip joint.

d. Install Universal Joint Assemblies (Short Drive Shaft).

- (1) Line up the keyways in the universal joint assemblies (K and M) with the keys in the short drive shaft (L), and slide the universal joints onto the shaft and key.
- (2) Install the short drive shaft with universal joints (par. 169b(4)-(7)).
- (3) Tighten the setscrews (R and S) securing the joints to the shaft.

171. Hanger Bearing Assembly

(fig. 82)

a. Removal.

- (1) Loosen the setscrew (V) securing the universal slip joint assembly (D) on the front end of hanger bearing

shaft (E). Loosen the setscrew (T) securing the universal joint assembly (K) on the rear end of hanger bearing shaft (E).

- (2) Unscrew the bolt (J) securing the hanger bearing brace (H) to the flywheel housing (F), and remove the bolt and lockwasher. Unscrew the bolt (G) securing the hanger bearing assembly (U) to the flywheel housing, and remove the bolt and lockwasher.
- (3) Pull the rear end of hanger bearing shaft (E) and key out from the universal joint assembly (K). Pull the front end of hanger bearing shaft (E) and key out from the universal slip joint assembly (K) and remove from the vehicle.

b. Installation.

- (1) Line up the front end of hanger bearing shaft (E) with the universal slip joint assembly (D), position the key in the shaft with the keyway in the joint, and slide the shaft and key into the joint. Line up the rear end of hanger bearing shaft (E) with the universal joint assembly (K), position the key in the shaft with the keyway in the joint, and slide the shaft and key into the joint.
- (2) Position the hanger bearing assembly (U) on the flywheel housing (F). Place a $\frac{1}{16}$ -inch lockwasher over the $\frac{9}{16} \times 1\frac{1}{2}$ bolt (G) and insert the bolt through the hole in the hanger bearing and screw the bolt into the flywheel housing. Place a $\frac{7}{16}$ -inch lockwasher over the $\frac{7}{16} \times 1\frac{1}{2}$ bolt (J), insert the bolt through the hanger bearing brace (H), and screw the bolt into the flywheel housing.
- (3) Tighten the setscrews (T and V) securing the universal slip joint assembly (D) and the universal joint assembly (K) to the hanger bearing shaft.

Section XV. INSTRUMENT CLUSTER, INSTRUMENTS, GAGES, SWITCHES, SENDING UNITS, AND HORN

172. General

a. Instrument Cluster (fig. 83). The speedometer, ammeter, oil pressure gage, water temperature gage, fuel gage, two instrument panel lights, and headlight high beam indicator light are mounted in the instrument panel mounting plate located in the instrument panel. This assembly is referred to as the instrument cluster. The location and function of the various units in the instrument cluster are described in paragraphs 25, 26, 29, 30, 31, 39, and 40.

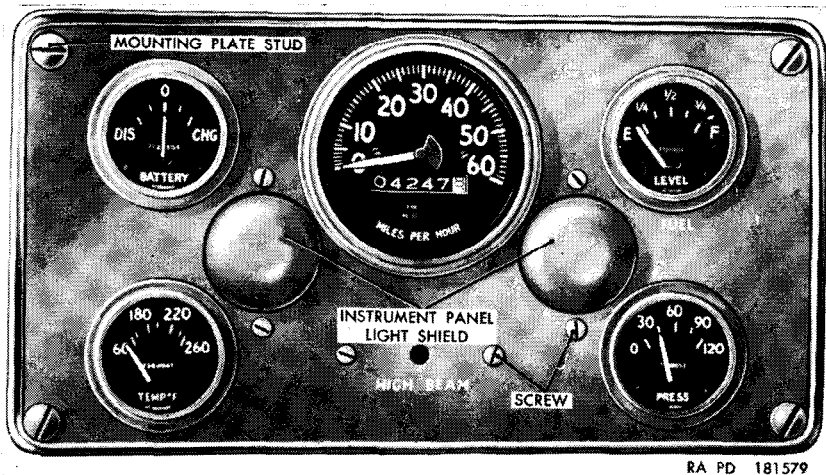

Figure 83. Instrument cluster—front view.

b. Switches. The location and function of the various switches, except for the stop light switch, are described in paragraphs 32, 33, and 34. The stoplight switch is attached to the front of the brake master cylinder, and is hydraulically operated by the action of the brake pedal.

c. Sending Units.

- (1) *Water temperature sending unit.* The water temperature sending unit is mounted on the right side of the cylinder head. It electrically transmits the water temperature to the water temperature gage through cable No. 33.
- (2) *Oil pressure sending unit.* The oil pressure sending unit, mounted on the lower left rear side of the cylinder block, electrically transmits the engine oil pressure to the oil pressure gage through cable No. 36.
- (3) *Fuel tank level sending unit.* The fuel tank level sending unit, mounted in the top section of the fuel tank, electrically transmits the level of the fuel in the tank to the fuel gage through cable No. 28.

d. Horn. The horn is of the vibrator-type, electrically operated, and fully waterproofed. It is mounted underneath the hood and attached to the left front fender by a mounting bracket. The horn is connected to the horn button by the two cables No. 25.

e. Cable Numbers. Standard circuit or cable numbers are used throughout. These cable numbers are stamped on small metal tags attached near the ends of each cable. These numbers are shown in the identification diagram (fig. 85).

173. Instrument Cluster

Note. The key letters noted in parentheses are in figure 84.

a. *Removal.* Disconnect the ground cable (par. 155c(2)). Turn each of the four instrument cluster mounting plate studs (fig. 83) one-half turn counterclockwise and pull instrument cluster free from instrument panel. Unscrew the nut securing the speedometer flexible shaft assembly to the speedometer and pull shaft free from speedometer. Disconnect cable No. 27, at connector (T), from the instrument cluster circuit breaker-to-gages wiring harness (AA). Disconnect cable No. 17 at connector (U). Disconnect cable No. 40 at double connector (R). Disconnect cable Nos. 8 and 9 from ammeter at terminals (H and L). Disconnect cable No. 33 from water temperature gage at terminal (M). Disconnect cable No. 36 from oil pressure gage at terminal (W). Disconnect

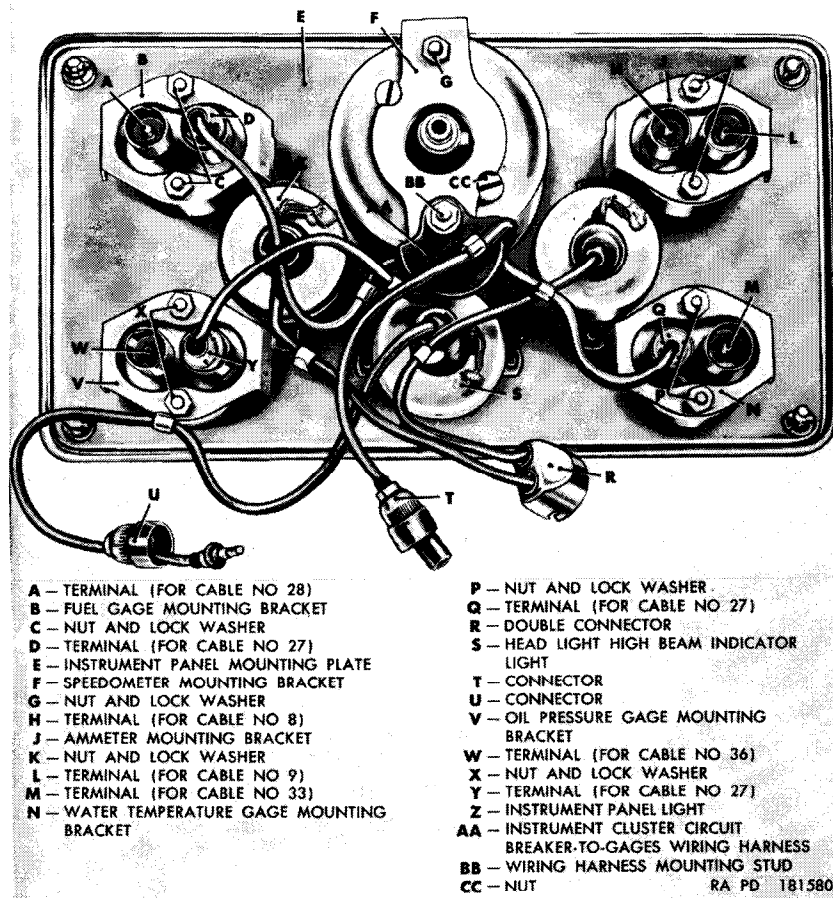
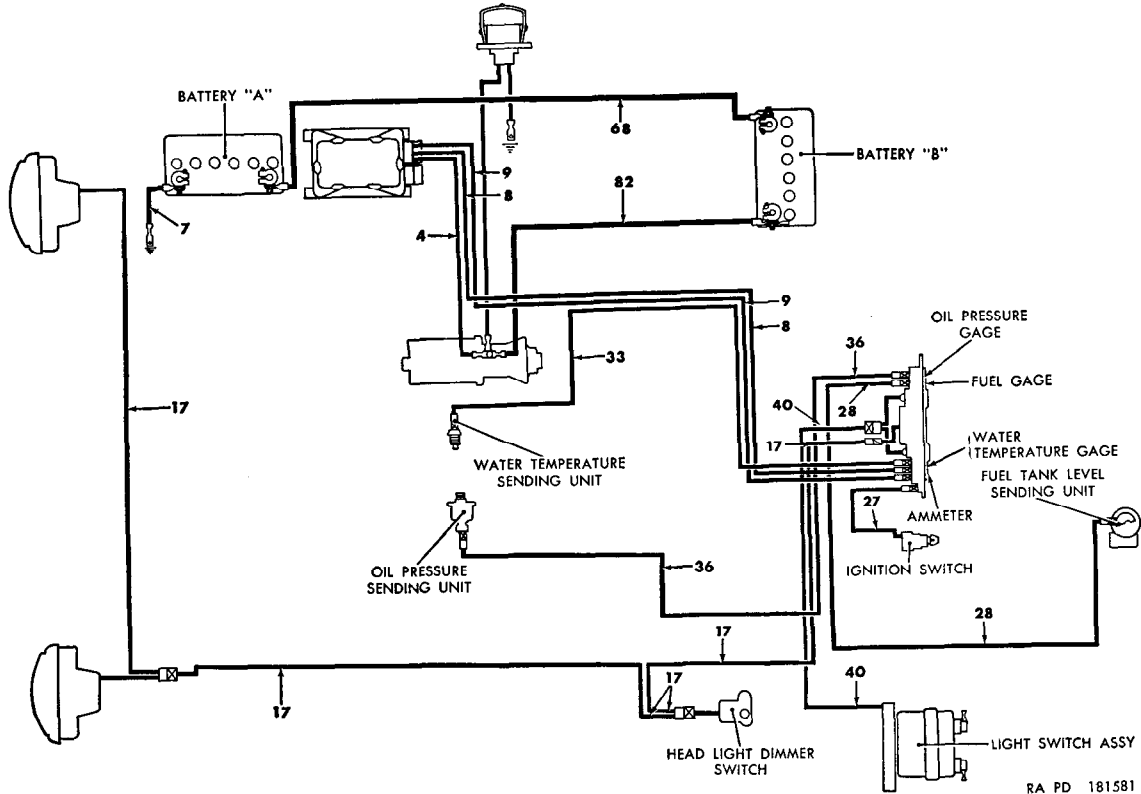

Figure 84. Instrument cluster—rear view.



RA PD 181581

Figure 85. Instruments, gages, switches, and sending units identification diagram.

cable No. 28 from fuel gage at terminal (A). Remove instrument cluster from instrument panel.

b. Installation. Position instrument cluster at instrument panel so that cables may be connected. Connect cable No. 36 to oil pressure gage at terminal (W), and cable No. 33 to water temperature gage at terminal (M). Connect cable No. 28 to fuel gage at terminal (A). Connect cable No. 8 to terminal (H) and cable No. 9 to terminal (L) of ammeter. Connect cable No. 40 to double connector (R). Connect cable No. 17 to connector (U). Connect cable No. 27 to connector (T). Position speedometer flexible shaft assembly in speedometer and tighten nut securing shaft to speedometer. Install instrument cluster in instrument panel and secure in position by turning the four instrument cluster mounting plate studs (fig. 83) one-half turn clockwise. Connect the ground cable (par. 155d(4)).

174. Ammeter

Note. The key letters noted in parentheses are in figure 84.

a. Removal. Disconnect ground cable (par. 155c(2)). Turn the four instrument cluster mounting plate studs (fig. 83) one-half turn counterclockwise and pull instrument cluster free from instrument panel. Disconnect cable Nos. 8 and 9 from terminals (H and L). Remove the two nuts and lockwashers (K) securing the ammeter and ammeter mounting bracket (J) to the instrument panel mounting plate (E) and remove ammeter and bracket.

b. Installation. Position ammeter on the instrument panel mounting plate (E) and rotate ammeter until it engages the locating slot in the plate. Position ammeter mounting bracket (J) over the ammeter and secure ammeter and bracket to plate with two No. 8 lockwashers and nuts (K). Connect cable No. 8 to terminal (H) and cable No. 9 to terminal (L). Position the instrument cluster on the instrument panel and turn the four instrument cluster mounting plate studs (fig. 83) one-half turn clockwise. Connect ground cable (par. 155d(4)).

175. Fuel Gage (fig. 84)

a. Removal. The removal procedure for the fuel gage is the same as the removal procedure for the ammeter (par. 174a) with the exception of the mounting bracket and the cables. The fuel gage is mounted on the fuel gage mounting bracket (B). Disconnect cable Nos. 27 and 28 from fuel gage terminals (D and A).

b. Installation. The installation procedure for the fuel gage is the same as installation procedure for the ammeter (par. 174b)

with the exception of mounting bracket and the cables. Connect cable No. 28 to terminal (A) and cable No. 27 to terminal (D) of the fuel gage mounting bracket.

176. Water Temperature Gage

(fig. 84)

a. Removal. The removal procedure for the water temperature gage is the same as the removal procedure for the ammeter (par. 174a) with the exception of the mounting bracket and the cables. Disconnect cable No. 27 from terminal (Q) and cable No. 33 from terminal (M) on water temperature gage mounting bracket (N).

b. Installation. The installation procedure for the water temperature gage is the same as installation procedure for the ammeter (par. 174b) with the exception of the mounting bracket and the cables. Connect cable No. 33 to terminal (M) and cable No. 27 to terminal (Q) on water temperature gage mounting bracket (N).

177. Oil Pressure Gage

(fig. 84)

a. Removal. The removal procedure for the oil pressure gage is the same as removal procedure for the ammeter (par. 174a) except for the mounting bracket and the cables. Disconnect cable No. 27 from terminal (Y) and cable No. 36 from terminal (W) on oil pressure gage mounting bracket (V).

b. Installation. Installation of the oil pressure gage is the same as installation of the ammeter (par. 174b) with the exception of the mounting bracket and the cables. Connect cable No. 36 to terminal (W) and cable No. 27 to terminal (Y) on oil pressure gage mounting bracket (V).

178. Speedometer

Note. The key letters noted in parentheses are in figure 84.

a. Removal. Turn the four instrument cluster mounting plate studs (fig. 83) one-half turn counterclockwise and pull the instrument cluster free from instrument panel. Unscrew the nut securing the speedometer flexible shaft assembly to the speedometer and pull shaft free from speedometer. Remove the nut (CC), lockwasher, and plain washer securing the instrument cluster circuit breaker-to-gages wiring harness (AA) to the wiring harness mounting stud (BB) and detach harness from the stud. Remove the plain washer, stud, and lockwasher from the speedometer mounting stud. Remove the nut and lockwasher (G) from the remaining speedometer mounting stud and remove speedometer

mounting bracket (F) and speedometer from instrument panel mounting plate (E).

b. Installation. Position the speedometer in the instrument panel mounting plate (E) and locate speedometer mounting bracket (F) over speedometer mounting studs. Install a No. 8 lockwasher on speedometer lower mounting stud, and install the wiring harness mounting stud (BB). Install the 0.322-inch ID, 0.582-inch OD plain washer, instrument cluster circuit breaker-to-gages wiring harness (AA), 0.203-inch ID, 0.50-inch OD plain washer, No. 8 lockwasher, and No. 8 nut (CC). Install a No. 8 lockwasher and nut (G) on remaining speedometer mounting stud. Install the speedometer flexible shaft assembly in speedometer and tighten nut. Position instrument cluster on instrument panel and turn the four instrument cluster mounting plate studs (fig. 81) one-half turn clockwise. When replacing speedometer flexible shaft assembly on vehicles with serial numbers below 44034 use shaft assembly—7522480 which is 54 $\frac{1}{2}$ inches long. When replacing the shaft assembly in vehicles with serial numbers 44031 use shaft assembly—7389881 which is 56 $\frac{3}{4}$ inches long.

179. Headlight High Beam Indicator Light

Note. The key letters noted in parentheses are in figure 84.

a. Removal. Disconnect the ground cable (par. 155c(2)). Turn the four instrument cluster mounting plate studs (fig. 83) one-half turn counterclockwise and pull instrument cluster free from instrument panel. Disconnect cable No. 17 at connector (U). Remove the two screws and lockwashers securing the headlight high beam indicator light and cover to the instrument panel mounting plate (E) and remove indicator light (S).

b. Installation. Position the headlight high beam indicator light on the instrument panel mounting plate (E) and secure in position with two No. 8 x $\frac{1}{2}$ screws and lockwashers. Connect cable No. 17 to connector (T). Position instrument cluster on instrument panel and turn the four instrument cluster mounting plate studs (fig. 81) one-half turn clockwise. Connect the ground cable (par. 155d(4)).

c. Lamp Replacement. Disconnect the ground cable (par. 155c(2)). Turn the four instrument cluster mounting plate studs (fig. 83) one-half turn counterclockwise and pull instrument cluster free from instrument panel. Turn the cover of the headlight high beam indicator light (S) counterclockwise and pull cover out of light body. Press in and turn lamp counterclockwise to disengage it from lamp socket. Install new lamp by pressing it into lamp socket and rotating clockwise. Position indicator

light cover on light body, press in and turn cover clockwise to engage with light body. Position instrument cluster on instrument panel and turn the four instrument cluster mounting plate studs (fig. 83) one-half turn clockwise. Connect the ground cable (par. 155d(4)).

180. Instrument Panel Lights

Note. The key letters noted in parentheses are in figure 84.

a. Removal. Disconnect the ground cable (par. 155c(2)). Turn the four instrument cluster mounting plate studs (fig. 83) one-half turn counterclockwise, and pull instrument cluster free from instrument panel. The two instrument panel lights with cables are permanently connected together in connector (R) and must be replaced as one unit. Disconnect cable No. 40 at connector (R). Remove the four screws and lockwashers securing the instrument panel lights to the instrument panel mounting plate (E) and remove lights (Z) and light shields (fig. 83).

b. Installation. Position the light shields in the instrument panel mounting plate (E). Position the two instrument panel lights on the plate and secure each with two No. 8 x $\frac{5}{16}$ screws and lockwashers. Connect cable No. 40 to connector (R). Position instrument cluster on instrument panel and turn the four instrument cluster mounting plate studs (fig. 83) one-half turn clockwise. Connect the ground cable (par. 155d(4)).

c. Lamp Replacement. Disconnect the ground cable (par. 155c(2)). Turn the four instrument cluster mounting plate studs (fig. 83) one-half turn counterclockwise and pull instrument cluster free from instrument panel. Press in on the cover of the instrument panel light (Z), turn counterclockwise and pull cover out of light body. Press in and turn lamp counterclockwise to disengage it from lamp socket and remove lamp. Install new lamp by pressing lamp into socket and turning clockwise. Install instrument panel light cover by pressing in and turning clockwise in lamp body. Position instrument cluster on instrument panel and turn the four instrument cluster mounting plate studs (fig. 83) one-half turn clockwise. Connect the ground cable (par. 155d(4)).

181. Ignition Switch

a. Removal. Disconnect ground cable (par. 155c(2)). Remove the bolt and lockwasher securing the ignition switch lever to the ignition switch (G, fig. 7) and remove lever. Remove the plain nut and lockwasher securing the ignition switch to the instrument panel and push switch out of instrument panel. Disconnect connectors on cable Nos. 11, 12, and 27 (fig. 80). Remove switch from reverse face of instrument panel.

b. Installation. Position switch and connect connectors on cable Nos. 11, 12, and 27 (fig. 80). Cable No. 85 (fig. 80) is an auxiliary cable and is not connected to any unit. Position ignition switch in instrument panel and secure with a ½-inch lockwasher and plain nut. Position ignition switch lever on the ignition switch and secure with a No. 8 lockwasher and No. 8 x ½ bolt. Connect ground cable (par. 155d(4)).

182. Light Switch

a. Removal. Disconnect ground cable (par. 155c(2)). Remove the four lockwasher bolts securing the light switch (E, fig. 7) to the instrument panel. Pull switch out from instrument panel and disconnect cable plug from the receptacle in the switch.

b. Installation. Connect cable plug to receptacle in light switch. Install light switch through instrument panel and secure in position with four No. 10 x ½ lockwasher bolts. Connect ground cable (par. 155d(4)).

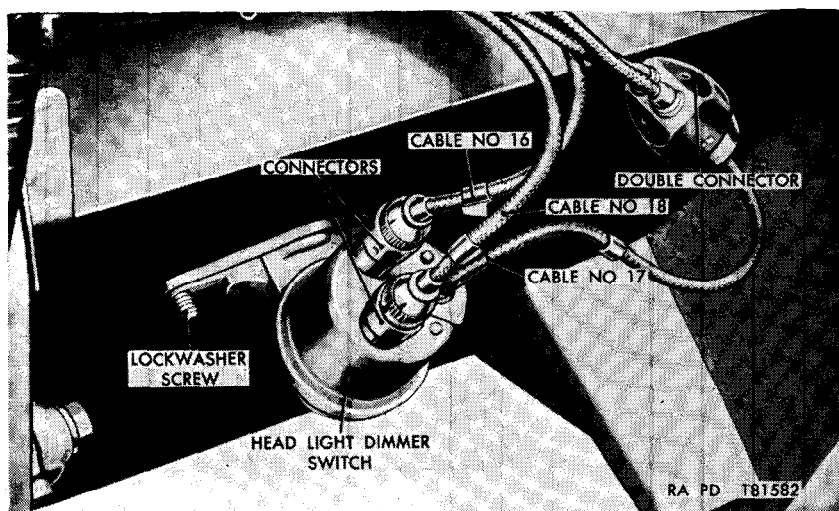

Figure 86. Headlight dimmer switch—installed.

183. Headlight Dimmer Switch (fig. 86)

a. Removal. Disconnect ground cable (par. 155c(2)). Disconnect connector on cable No. 17. Disconnect connectors on cable Nos. 16 and 18. Remove the two lockwasher screws securing the switch to the underside of floor pan and remove switch.

b. Installation. Position headlight dimmer switch in floor pan and secure with two ¼ x ½ lockwasher screws. Connect cable

Nos. 16 and 18 to switch. Connect cable No. 17 to double connector. Connect ground cable (par. 155d(4)).

184. Horn Button and Switch

a. Horn Button.

- (1) *Removal.* Pull the horn button cap off the steering wheel nut. Pull the rod extending from the horn button to the horn switch out of the steering gear.
- (2) *Installation.* Slide the rod extending from the horn button to the horn switch into the steering gear. Snap the horn button over the top of and into the groove in the steering wheel nut.

b. Horn Switch.

- (1) *Removal.* Disconnect the ground cable (par. 155c(2)). Disconnect the connectors on the two cables No. 25 (fig. 80). This disconnects the horn switch from the wiring harness. Slide the two spring clips to the rear off the horn switch harness and the left front fender splash shield. Unscrew switch from bottom of steering gear housing and remove switch, using care that the rod does not slide out of the steering gear.
- (2) *Installation.* If necessary, push the rod back into the steering gear and screw horn switch into bottom of steering gear housing. Position the switch wiring harness against the inside of the left front fender splash shield and slide the two clips onto the harness and shield. Connect the connectors in the two cables No. 25 (fig. 80). Connect ground cable (par. 155d(4)).

185. Horn

a. *Removal.* Disconnect the connectors in the two cables No. 25 (fig. 86). Remove the two cap screws and lockwashers securing the horn to the horn bracket and remove horn.

b. *Installation.* Position the horn on the horn bracket and secure with two $\frac{1}{4}$ -inch lockwashers and $\frac{1}{4} \times \frac{3}{8}$ cap screws. Connect the connectors in the two cables No. 25 (fig. 80).

186. Stoplight Switch

(fig. 80)

a. *Removal.* Disconnect the connectors near the stoplight switch in the two cables No. 75. Unscrew the stoplight switch from the front of the brake master cylinder.

b. *Installation.* Screw the stoplight switch into the front of the brake master cylinder. Connect the connectors in the two cables No. 75. Bleed brake system (par. 246).

c. Replacement of Stoplight Switches.

- (1) To replace old-type switch 7760414 with new-type switch 7388813, sever the electric cables from the old-type switch as close as possible to the switch body and strip these cable ends to permit the installation of two male terminals 572929, the waterproof cable connector grommet 573005, the grommet adapting bushing 572999, and the female Y connector waterproof shell 573008. Utilizing this modified portion of the old-type switch and two electrical connector terminal sleeves 573000, connect the new-type switch to the chassis harness.
- (2) To replace new-type switch 7388813 with old-type switch 7760414, cut the male waterproof cable connector shell 573010 and the female waterproof cable connector shell 573007 off the old-type switch. Replace with the male waterproof connector shell 573009, utilizing the terminals, grommets, and bushings of the old-type switch. Connect the chassis harness to the old-type stoplight switch.

187. Water Temperature Sending Unit

(fig. 87)

a. *Removal.* Disconnect cable No. 33 from the water temperature sending unit. Unscrew sending unit from cylinder head.

b. *Installation.* Screw sending unit into cylinder head. Connect cable No. 33 to the sending unit.

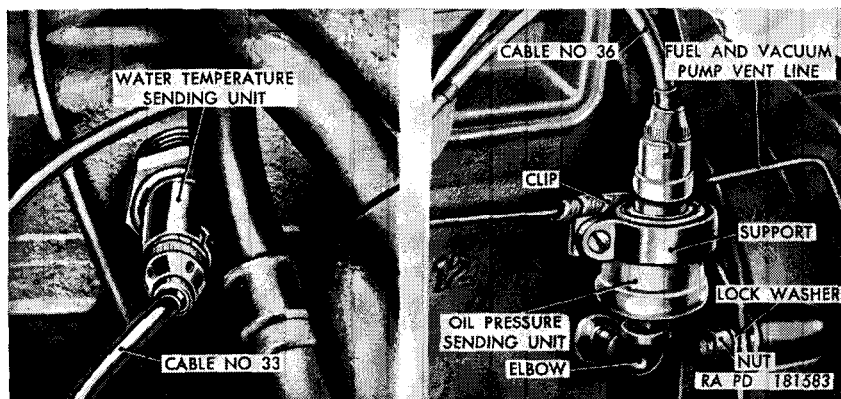

Figure 87. Water temperature and oil pressure sending units—installed.

188. Oil Pressure Sending Unit

(fig. 87)

a. *Removal.* Disconnect cable No. 36 from oil pressure sending unit. Remove the nut and bolt from the clip securing the fuel and

vacuum pump vent line to the oil pressure sending unit support. Free vent line and clip from support. Remove the nut and lockwasher from the bolt securing the support to the engine, and lift support off sending unit. Unscrew sending unit from elbow.

b. Installation. Screw the oil pressure sending unit into the elbow. Position the oil pressure sending unit support around the sending unit and over the mounting bolt and secure support to engine with a $\frac{3}{8}$ -inch lockwasher and nut. Position the clip securing fuel and vacuum pump vent line in the sending unit support and secure in position with a $\frac{1}{4}$ x $\frac{3}{4}$ bolt and $\frac{1}{4}$ -inch plain nut. Connect cable No. 36 to the sending unit.

189. Fuel Tank Level Sending Unit (fig. 50)

a. Removal. Remove driver's seat (par. 268). Disconnect cable No. 28 from the sending unit. Remove the five bolts and sealing washers securing the sending unit to fuel tank and remove sending unit and gasket. Discard gasket.

b. Installation. Position a new sending unit gasket on the fuel tank and aline the mounting holes in the gasket with those in the fuel tank. Install the sending unit in the fuel tank and aline the mounting holes in the unit. Secure the sending unit in position with five copper sealing washers and No. 8 x $\frac{7}{16}$ bolts. Connect cable No. 28 to the sending unit. Install driver's seat (par. 268).

Section XVI. RADIO INTERFERENCE SUPPRESSION

190. Purpose

a. Radio interference suppression is the elimination or minimizing of electrical disturbances which interfere with radio reception or disclose the location of the vehicle to sensitive electrical detectors. It is important that all vehicles, with or without radio equipment, be suppressed properly to prevent interference with radio reception of neighboring vehicles.

b. Radio interference suppression is accomplished in this vehicle by use of filters, capacitors, resistors, ground straps, and metallic sheathing on any cable carrying currents that may cause interference.

191. Description

a. Ignition System. Ignition system suppression is achieved by an ignition filter assembly, spark plug resistors, and shielding the spark plug cables.

b. Generating System. Generating system suppression is accomplished by capacitors, a filter at the generator regulator, shielding the generator regulator cables, and bond straps at the generator regulator.

192. Ignition System

a. The ignition filter assembly is a fully-sealed, waterproof unit. In vehicles before serial No. 20601, it is located in the engine compartment, on the fire wall above the starter assembly. Beginning with serial No. 20601, the filter is installed in the wiring harness filter receptacle on the distributor body. The filter is connected in the ignition primary circuit, to suppress any stray current originating in the circuit.

b. All spark plugs are equipped with solid type resistors.

c. The spark plug cables are shielded. The shielding is grounded to the spark plug body at one end and the distributor cover, cap assembly at the other end.

193. Generating System

a. Generator Assembly. The generator assembly is a sealed, waterproof, shielded unit with a built-in capacitor which may be replaced, if necessary, by ordnance maintenance units.

b. Generator Regulator Assembly. The generator regulator assembly is a sealed, waterproof, shielded unit, with built-in resistors, one for each unit in the assembly. The cushioned regulator assembly is grounded to the regulator base. All connecting cables are shielded and grounded.

194. Fasteners and Ground Straps

a. Fasteners. Cables in the primary and secondary ignition circuits, and generator assembly-to-generator regulator assembly circuits are shielded. The shielding is grounded to the various units by threaded connectors (fasteners). The units are also grounded to the engine and/or vehicle frame by the mountings and mounting bolts.

b. Ground Straps. Four ground straps (fig. 67) ground the generator regulator assembly to the mounting support, one strap for each mounting bolt. The engine is grounded to the vehicle frame by a ground strap at the right front of the engine. The entire electrical system is grounded through the battery "B" negative terminal and cable No. 7. See figure 80 and table IV.

Section XVII. CLUTCH

195. Description and Data

a. Description. The clutch is located between the engine and transmission and, on early production vehicles, inclosed in a standard automotive bell housing. Late production vehicles are equipped with a pressurized-type bell housing to prevent entrance of water when fording. The clutch is a single plate-type, composed (in addition to the engine flywheel) of two major units, the clutch pressure plate and driven disk assemblies. The clutch serves to engage or disengage the engine and the power train. The pressure plate assembly is adjusted when manufactured and requires no other adjustment.

b. Data.

Pressure plate assembly:

Manufacturer	Auburn Mfg Co
Manufacturer's No	ABF-80501-38
Ordance No	7372664
Type	single dry plate
Size	8½ in.

Driven disk assembly:

Manufacturer	Borg and Beck
Manufacturer's No	BB-1196
Ordance No	7372661

196. Clutch Linkage Adjustment

The clutch pedal must have at least 1¼-inch free travel (fig. 88). To adjust clutch pedal free travel, loosen jamnut (fig. 89)

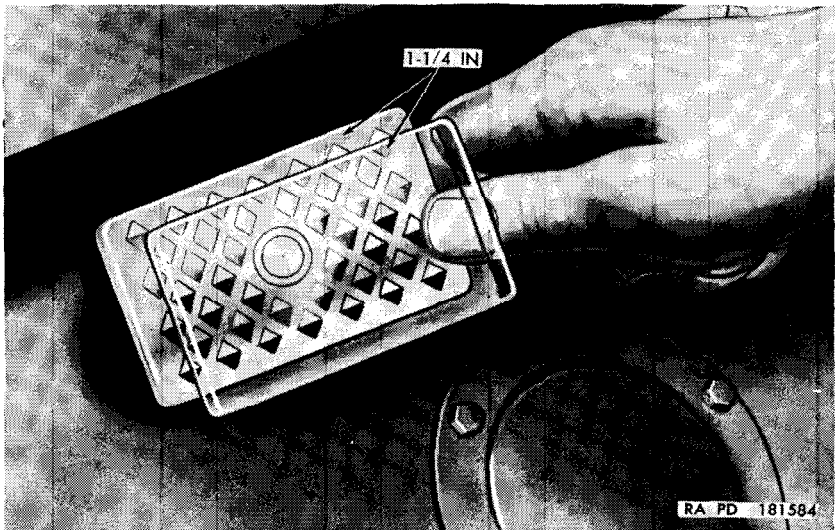

Figure 88. Clutch pedal free travel.

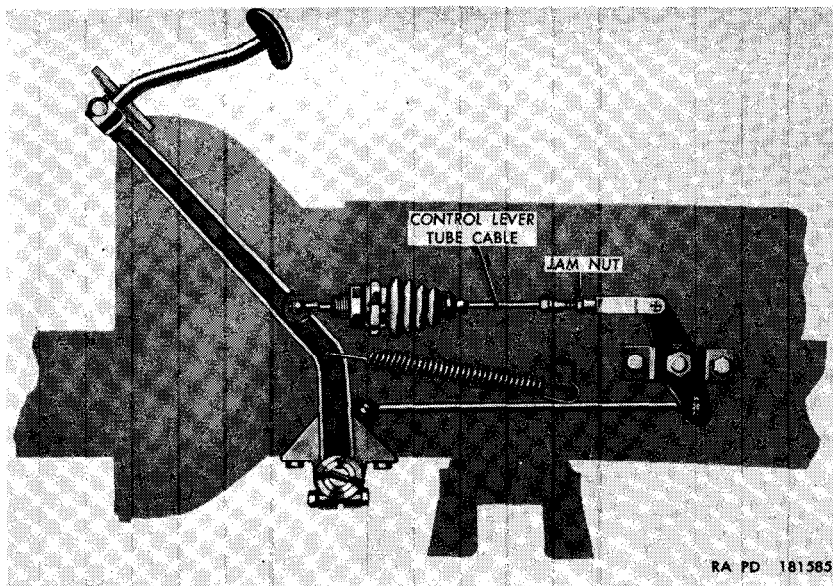

Figure 89. Clutch pedal linkage adjustment.

on control lever tube cable. Unscrew cable until pedal has a $1\frac{1}{4}$ -inch free travel. When correct adjustment has been obtained, tighten jamnut.

Section XVIII. TRANSFER AND POWER-TAKE-OFF ASSEMBLIES

197. Description and Data

a. Description (figs. 31, 32, and 90). The transfer assembly, an added gear unit attached to the rear of the transmission, provides either a direct drive, or an additional gear reduction for operation on unusual terrain. The transfer provides a means of engaging or disengaging the front axle drive. On the rear of the transfer assembly are mounted the hand brake assembly and, on some vehicles, a power-take-off assembly. The power-take-off assembly, when supplied, transmits power from the transfer to a winch (par. 165). The single-speed power-take-off is engaged or disengaged by the power-take-off gearshift control lever (fig. 12).

b. Data.

Transfer assembly:

Manufacturer ----- Spicer Mfg Corp

Ratio:

High range ----- 1.00:1

Low range ----- 2.43:1

Lubricant capacity ----- 3 pt

Power-take-off:

Manufacturer ----- Ramsey Winch Mfg Co

198. Coordination With Ordnance Maintenance Unit

Refer to paragraph 2 for coordination with an ordnance maintenance unit.

199. Organizational Maintenance

Organizational maintenance of the transfer assembly consists of lubrication (par. 66), inspection for looseness or noise, and the testing of the controls for proper operation (pars. 17 and 18).

200. Removal

(fig. 90)

a. Remove the power plant (par. 116).

b. Remove five lockwasher screws securing the transfer rear cover and remove the cover. (If the vehicle is equipped with a power-take-off instead of a transfer rear cover, loosen setscrew (Q, fig. 82) securing universal joint assembly (M, fig. 82) to power-take-off output shaft (N, fig. 82). Remove five lockwasher screws securing power-take-off to the transfer assembly. Pull the power-take-off straight back until the main drive gear is clear of the transfer assembly and the output shaft is out of the universal joint.) Discard gasket. Working through the hole in the rear of the transfer assembly, remove the cotter pin, nut, plain washer, and transfer input gear from the transmission main shaft. Remove five bolts and lockwashers securing the transfer assembly to the transmission assembly and remove the transfer. Discard gasket. Make certain that the transmission mainshaft bearing is in place against the rear face of the transmission.

201. Installation

a. Position a new gasket on the rear face of the transmission assembly. Make certain that the transmission main shaft bearing is in place. Position the transfer assembly against the rear of the transmission. Install the $\frac{3}{8}$ x $1\frac{1}{8}$ bolt with lockwasher at the bottom just over the rear motor mount. Install two $\frac{3}{8}$ x 1 bolts and lockwashers on the left side and one on the right side at the top through the transfer flange and into the transmission. Install the $\frac{3}{8}$ x 1 bolt and lockwasher on the right side at the bottom through the flange of the transmission and into the transfer. Draw the bolts up evenly.

b. Working through the opening at the rear of the transfer assembly, place the transfer input gear onto the transmission main shaft and install the plain washer, $\frac{7}{16}$ -inch nut, and cotter pin securing the gear to the main shaft. Place a new gasket around the opening and position the transfer rear cover on the gasket.

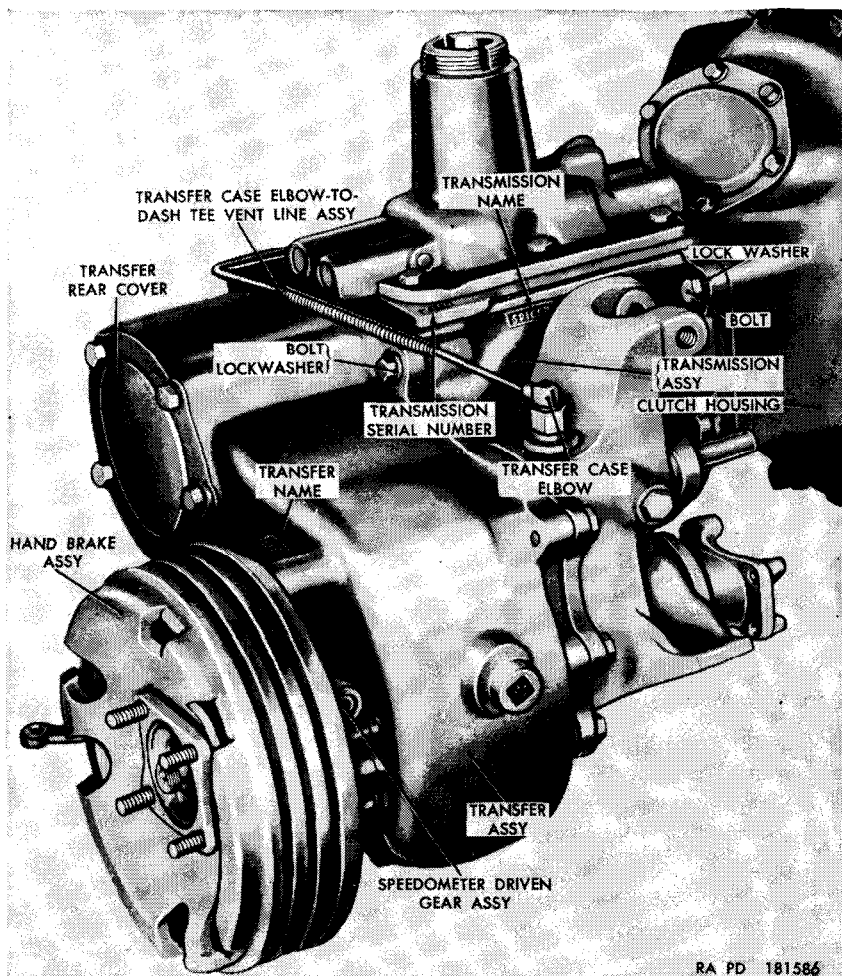

Figure 90. Transmission and transfer installed on engine.

(If the vehicle is equipped with a power-take-off instead of a transfer rear cover, align the key in the power-take-off output shaft (N, fig. 82) with the keyway in universal joint assembly (M, fig. 82) and slide the shaft into the joint.) Install five $\frac{3}{8}$ x 1 lockwasher screws securing the cover on the power-take-off. If power-take-off was installed, tighten setscrew (Q, fig. 82) securing the power-take-off output shaft to the universal joint.

c. Install the power plant (par. 119).

202. Power-Take-Off Assembly

a. *Removal.* Unscrew and remove the knob from the power-take-off gearshift control lever (fig. 12). Remove the four screws

(fig. 12) securing the grommet retaining plate (NN, fig. 7) to the floor pan and remove the plate and the two grommets by lifting straight up and off the lever. Remove the four screws from the power-take-off shift lever plate and lift the plate with the power-take-off gearshift lever out of the power-take-off. Loosen setscrew (Q, fig. 82) securing universal joint assembly (M, fig. 80) to the power-take-off output shaft (N, fig. 82). Remove five bolts and lockwashers securing the power-take-off assembly to the transfer assembly. Pull the power-take-off straight back until the main drive gear is clear of the transfer assembly and the power-take-off output shaft is out of universal joint assembly. Lower the power-take-off to the floor and remove from under the vehicle. Discard the power-take-off housing cover gasket and the gasket between the power-take-off housing and the transfer.

b. Installation. Place a new gasket between the power-take-off and the transfer and position the power-take-off at the rear of the transfer. Aline the key in the power-take-off output shaft (N, fig. 82) with the keyway in the universal joint assembly (M, fig. 82). Push the shaft into the universal joint and position the power-take-off on the transfer. Place $\frac{3}{8}$ -inch lockwashers over $\frac{3}{8}$ x 1 bolts and push the bolts through the case of the power-take-off and screw into the transfer. Tighten the setscrew (Q, fig. 82) securing the universal joint assembly (M, fig. 82) to the power-take-off output shaft (N, fig. 82). Install the power-take-off gearshift control lever (HH, fig. 7), with the shift lever plate, in the power-take-off and install four No. 10 screws in the plate. Slide the grommet (LL, fig. 7), the grommet (MM, fig. 7), and the grommet retaining plate (NN, fig. 7) over the gearshift lever in the above order and screw the four No. 10 x $\frac{5}{8}$ screws through the plate and into the floor pan. Screw the knob onto the gearshift control lever. Start the engine and test the power-take-off assembly for proper shifting or noise.

Section XIX. TRANSMISSION ASSEMBLY

203. Description and Data

a. Description (figs. 31, 32, and 90). The transmission assembly is three-speed, selective sliding gear-type, with synchromesh second and third speed gears. The gears are shifted (see shifting instructions plate on dash) by a cane-type ball and socket shifting lever, located to the right of the driver. The transmission is sealed for underwater operation.

b. Data.

Manufacturer	Borg-Warner Corp, Warner Gear Div
Type	sychromesh
Speeds	three forward, one reverse
Ratios:	
Low	2.798:1
Intermediate	1.551:1
High	1.000:1
Reverse	3.798:1
Lubricant capacity	2 pt

204. Coordination With Ordnance Maintenance Unit

Refer to paragraph 2 for coordination with an ordnance maintenance unit.

205. Organizational Maintenance

Organizational maintenance of the transmission assembly consists of lubrication (par. 66), inspection for looseness or noise, and proper operation of the controls (par. 19).

206. Removal

- a. Remove the power plant (par. 116).
- b. Remove the transfer assembly (par. 200*b*).
- c. Remove the two bolts and lockwashers securing the clutch linkage inspection cover (fig. 31) and remove the cover. Reach through the inspection hole and disconnect the clutch release bearing carrier spring from the carrier and the bracket on the clutch housing and remove the spring. Remove four bolts and lockwashers (fig. 90) securing the transmission assembly to the clutch housing and remove the transmission by sliding straight back until the input shaft is clear of the housing.

207. Installation

a. Insert the transmission input shaft into the clutch housing, through the clutch release bearing and clutch disk, and into the clutch pilot bearing. Install four $\frac{7}{16}$ x $1\frac{1}{4}$ bolts and lockwashers (fig. 90) securing the transmission to the clutch housing. Working through the inspection hole in the top of the housing, install the clutch release bearing carrier spring by hooking one end to the bracket on the housing and the other end in the hole in the carrier. Place the clutch linkage inspection cover (fig. 31) over the inspection hole and secure with two $\frac{1}{4}$ x $\frac{1}{2}$ bolts and lockwashers.

b. Install the transfer assembly (par. 201).

c. Install the power plant (par. 119).

d. Make a record of replacement on DA Form 478, MWO and

Section XX. PROPELLER SHAFTS WITH UNIVERSAL JOINT ASSEMBLIES

208. Description and Data

a. *Description.* The front propeller shaft with universal joint assemblies (fig. 91) transmits power from the transfer to the front axle. The rear propeller shaft with universal joint assemblies (fig. 92) transmits power from the transfer to the rear axle. Each assembly includes a propeller shaft, a universal joint sleeve assembly, and two universal joint assemblies. Corresponding parts of both the front and rear assemblies are the same except for the length of the shaft and the front universal joint assembly of the rear propeller shaft. This universal joint assembly includes the propeller shaft flange yoke, and is modified accordingly. The four universal joint assemblies are roller bearing-types.

b. *Data.*

Manufacturer	Spicer Mfg Corp
Type of shaft	tube, welded seam
Type of joints	roller bearing

209. Propeller Shafts With Universal Joint Assemblies

a. *Remove Front Propeller Shaft with Universal Joint Assemblies* (fig. 91).

- (1) Remove the four nuts from the two U-bolts holding the universal joint assembly to the transfer front axle output shaft yoke. Remove the two U-bolts and separate the joint from the yoke.

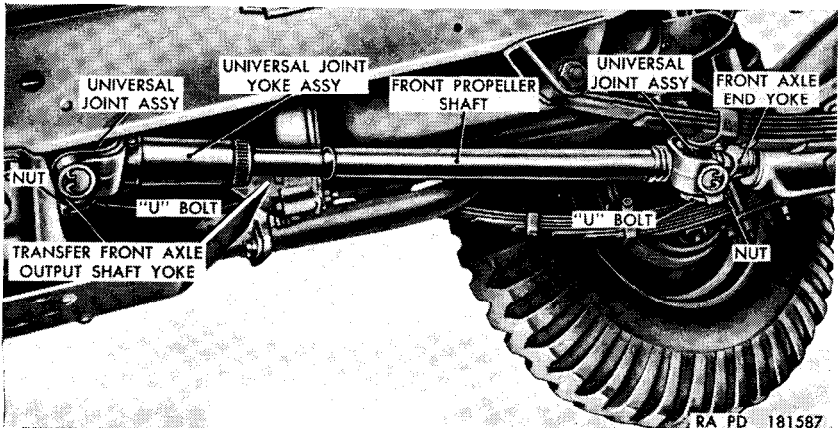

Figure 91. Front propeller shaft with universal joint assemblies—installed.

- (2) Remove the four nuts from the two U-bolts holding the universal joint assembly to the front axle end yoke. Remove the two U-bolts and remove the front propeller shaft with universal joint assemblies from the vehicle.

b. Remove Rear Propeller Shaft with Universal Joint Assemblies (fig. 92).

- (1) Remove the four nuts from the two U-bolts holding the universal joint to the rear axle end yoke. Remove the two U-bolts and separate the joint from the yoke.

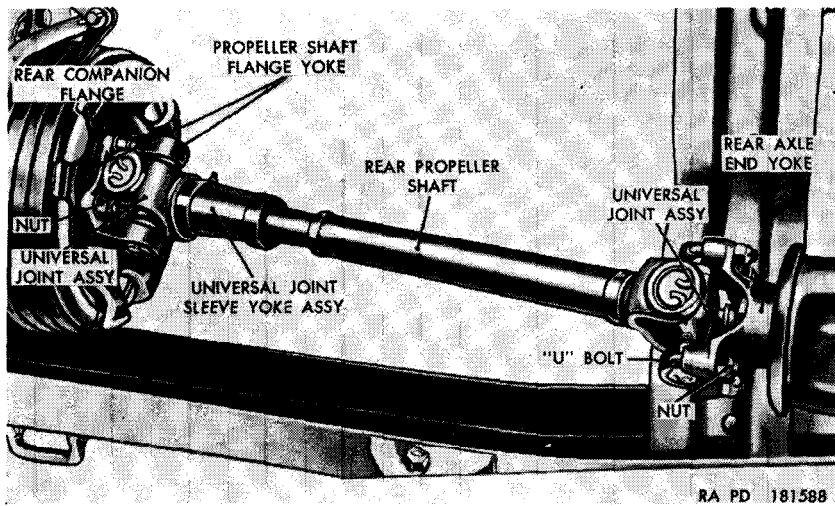

Figure 92. Rear propeller shaft with universal joint assemblies—installed.

- (2) Remove the four nuts and lockwashers holding the propeller shaft flange yoke to the rear companion flange and remove the rear propeller shaft with universal joint assemblies from the vehicle.

c. Install Front Propeller Shaft with Universal Joint Assemblies (fig. 91).

- (1) Position the universal joint assembly, on the end of the front propeller shaft, on the front axle end yoke. Install the two U-bolts over the ends of the universal joint and through the holes in the yoke, and secure in place with four $\frac{5}{16}$ -inch nuts.
- (2) Position the universal joint assembly, on the end of the universal joint sleeve yoke assembly, on the transfer front axle output shaft yoke. Install the two U-bolts over the ends of the universal joint and through the holes in the yoke, and secure in place with four $\frac{5}{16}$ -inch nuts.

d. Install Rear Propeller Shaft with Universal Joint Assemblies (fig. 92).

- (1) Position the propeller shaft flange yoke on the bolts projecting from the rear companion flange and secure in place with four lockwashers and nuts.
- (2) Position the universal joint assembly, on the end of the propeller shaft, on the rear axle end yoke. Install the two U-bolts over the ends of the universal joint and through the holes in the yoke, and secure in place with four $\frac{5}{16}$ -inch nuts.

210. Universal Joint Assemblies (fig. 93)

Note. The operations for removing and installing the universal joint assemblies from the front end of the front propeller shaft, the rear end of the rear propeller shaft, and the universal joint sleeve yoke assembly of the front shaft are exactly the same and will therefore be referred to figure 91 which shows the rear propeller shaft.

a. Remove Universal Joint Assembly From the Propeller Shaft Flange Yoke and From the Rear Propeller Shaft Universal Joint Sleeve Yoke Assembly.

- (1) Remove rear propeller shaft with universal joint assemblies from vehicle (par. 209b).
- (2) Remove the two journal bearing snap rings (A) from the propeller shaft flange yoke (Y) by squeezing the open ends together with a pair of pliers. Place a brass drift against the end of one of the bearings (B) and drive it into the propeller shaft flange yoke (Y) until the bearing on the other end of the journal (F) is driven out of the yoke. Pull the bearing (B), journal bearing oil seal (C), and journal bearing oil seal retainer (D) from the journal, being careful not to lose the rollers. Using the brass drift against the end of the journal from which the bearing has just been removed, drive the journal back until the second bearing (B) has been driven out of the yoke. Pull the second bearing (B), journal bearing oil seal (C), and journal bearing oil seal retainer (D) from the journal, being careful not to lose the rollers. Slide the yoke to one side of the journal and work the journal out of the yoke.
- (3) Remove the two journal bearing snap rings (A), bearings (B), journal bearing oil seals (C), and journal bearing oil seal retainers (D), holding the journal (F) to the universal joint sleeve yoke (G), following the procedures given in (2) above.

- A — JOURNAL BEARING SNAP RING
- B — BEARING
- C — JOURNAL BEARING OIL SEAL
- D — JOURNAL BEARING OIL SEAL RETAINER
- E — LUBRICATION FITTING
- F — JOURNAL
- G — UNIVERSAL JOINT SLEEVE YOKE
- H — UNIVERSAL JOINT SLEEVE YOKE DUST CAP
(CORK) PACKING WASHER
- J — UNIVERSAL JOINT SLEEVE YOKE DUST CAP
(S) SPLIT WASHER
- K — UNIVERSAL JOINT SLEEVE YOKE DUST CAP

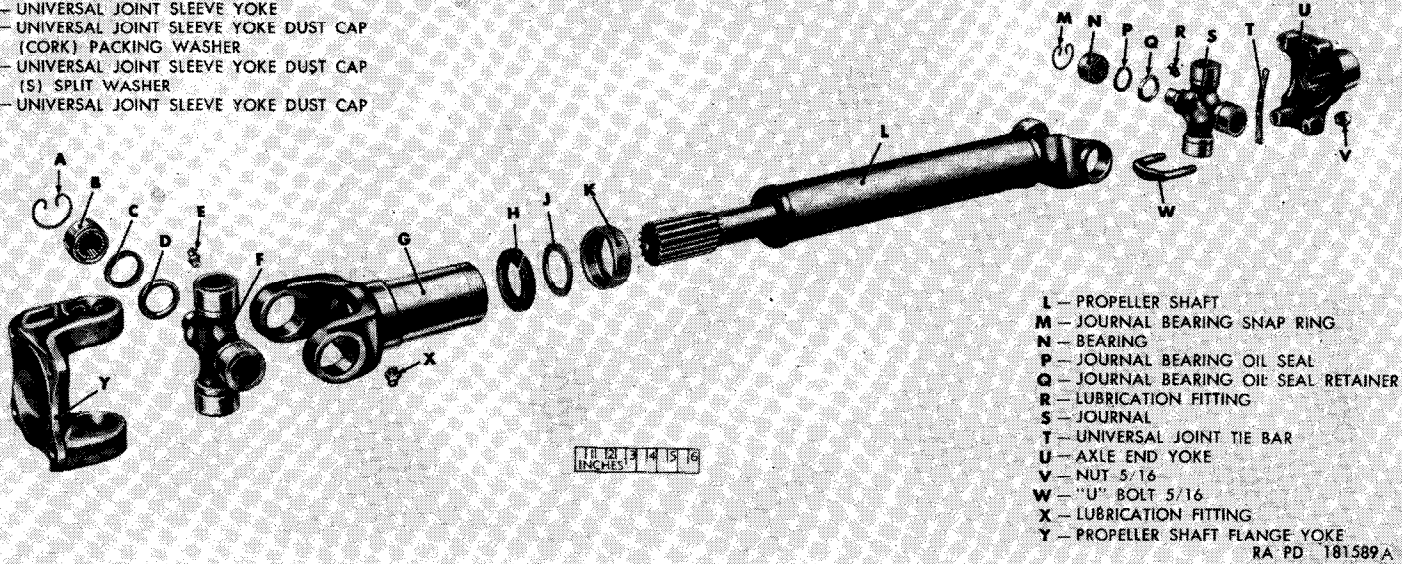

Figure 93. Rear propeller shaft with universal joint assemblies and axle end yoke—exploded view.

b. Remove Universal Joint Assembly From Rear Propeller Shaft.

- (1) Remove rear propeller shaft with universal joint assemblies from the vehicle (par. 209b).
- (2) Remove the two journal bearing snap rings (M) from the propeller shaft (L) by squeezing the open ends together with a pair of pliers. Place a brass drift against the end of one of the bearings (N) and drive it into the propeller shaft yoke until the bearing on the other end of the journal (S) is driven out of the propeller shaft. Pull the latter bearing (N), journal bearing oil seal (P), and journal bearing oil seal retainer (Q) from the journal (S), being careful not to lose the rollers. Using the brass drift against the end of the journal from which the bearing has just been removed, drive the journal back until the second bearing (N) has been driven out of the propeller shaft yoke. Pull the second bearing (N), journal bearing oil seal (P), and journal bearing oil seal retainer (Q) from the journal, being careful not to lose the rollers. Slide the yoke to one side of the journal and work the journal out of the yoke.

c. Remove Universal Joint Assembly From Front Universal Joint Sleeve Yoke Assembly.

- (1) Remove front propeller shaft with universal joint assemblies from the vehicle (par. 209a).
- (2) Remove the universal joint assembly (fig. 91) from the front universal joint sleeve yoke assembly following the procedure given in *b*(2) above.

d. Remove Universal Joint Assembly From Front Propeller Shaft.

- (1) Remove front propeller shaft with universal joint assemblies from the vehicle (par. 209a).
- (2) Remove universal joint assembly (fig. 91) from the front propeller shaft following the procedures given in *b*(2) above.

e. Install Universal Joint Assembly in Front Propeller Shaft.

Push a journal bearing oil seal retainer (Q) onto each of the two trunnions of the journal (S), convex side first. Push a journal bearing oil seal (P) onto each trunnion of the journal and into the concave side of the retainer. Insert the journal (S) into the propeller shaft (L) so that the trunnions will be inside the holes in the yoked end of the shaft, and the universal joint tie bar (T) will face away from the shaft. Apply grease to the rollers in the two bearings (N) so that the rollers will not fall out. Carefully start the two bearings (N) onto the trunnions and into the holes

in the yoked end of the propeller shaft (L). Using a brass drift, carefully tap the bearings in until their outer ends are just inside the snap ring grooves in the holes. Install the two journal bearing snap rings (M) to hold the bearings in place by squeezing the ends together with a pair of pliers.

f. Install Universal Joint Assembly in Front Universal Joint Sleeve Yoke Assembly. Install the universal joint assembly (fig. 91) in the front universal joint sleeve yoke assembly following the procedures given in *e* above.

g. Install Universal Joint Assembly in Rear Propeller Shaft. Install the universal joint assembly in the propeller shaft (L) following the procedures given in *e* above.

h. Install the Universal Joint Assembly in the Propeller Shaft Flange Yoke and in the Rear Propeller Shaft Universal Joint Sleeve Yoke Assembly.

- (1) Install the universal joint assembly in the universal joint sleeve yoke (G) following the procedures given in *e* above.
- (2) Install the propeller shaft flange yoke (Y) on the two remaining bearings (B) of the universal joint assembly installed in (1) above. Follow procedures given in *e* above.

211. Universal Joint Sleeve Yoke Assemblies

(fig. 93)

a. General. The universal joint sleeve yoke assemblies (figs. 91 and 92) used on the front and rear propeller shafts are practically identical and removal and installation procedures will be referenced to the rear sleeve yoke illustrated in figure 91.

b. Remove Front Universal Joint Sleeve Yoke Assembly.

- (1) Disconnect the universal joint from the transfer front axle output shaft yoke (fig. 89) (par. 209a(1)), and lower the rear end of the shaft assembly to the ground.
- (2) Unscrew the universal joint sleeve yoke dust cap (K) from the universal joint sleeve yoke and slide the yoke off the splined shaft. Remove the universal joint sleeve yoke dust cap (cork) packing washer (H) and the universal joint sleeve yoke dust cap split washer (J) from the universal joint sleeve yoke dust cap (K). Work the two washers and cap off the shaft over the splines.
- (3) If necessary, remove the universal joint assembly from the universal joint sleeve yoke (G) following the procedures given in paragraph 210c(2).

c. Remove Rear Universal Joint Sleeve Yoke Assembly.

- (1) Remove the four nuts and lockwashers holding the propeller shaft flange yoke to the rear companion flange and lower the rear end of the shaft assembly to the ground.
- (2) Unscrew the universal joint sleeve yoke dust cap (K) from the universal joint sleeve yoke (G) and slide the yoke with universal joint assembly and flange yoke off the splined shaft. Remove the universal joint sleeve yoke dust cap (cork) packing washer (H) and the universal joint sleeve yoke dust cap split washer (J) from the universal joint sleeve yoke dust cap (K). Work the two washers and cap off the splines.
- (3) If necessary, remove the universal joint assembly with propeller shaft flange yoke (Y) following the procedures given in paragraph 210a(3).

d. Install Rear Universal Joint Sleeve Yoke Assembly.

- (1) If rear universal joint assembly and propeller shaft flange yoke (Y) were removed, assemble them with the universal joint sleeve yoke (G) following procedures given in paragraph 210h(1).
- (2) Slide universal joint sleeve yoke dust cap over splines on end of propeller shaft (L) convex side first. Slide universal joint sleeve yoke dust cap split washer (J) over splines and install in dust cap (K). Slide universal joint sleeve yoke dust cap (cork) packing washer (H) over splines and install in dust cap. Slide the universal joint sleeve yoke (G) onto the splined end of the propeller shaft in such a position that the yoke is parallel with the yoke on the propeller shaft (L). Screw the universal joint sleeve yoke dust cap (K), with the two washers inclosed, onto the end of the yoke.
- (3) Lift the front end of the shaft, position the propeller shaft flange yoke (Y) on four bolts protruding from the rear companion flange, and install four lockwashers and nuts holding the yoke to the flange.

e. Install Front Universal Joint Sleeve Yoke Assembly.

- (1) If the universal joint assembly was removed from the front universal joint sleeve yoke, install by following procedures given in paragraph 210f.
- (2) Install front universal joint sleeve yoke assembly on front propeller shaft following procedures given in d(2) above.
- (3) Lift the rear end of the shaft, position the universal joint assembly on the transfer front axle output shaft

yoke (fig. 91), put the two U-bolts over the bearings and through the holes in the shaft yoke, and install the four $\frac{5}{16}$ -inch nuts.

Section XXI. REAR AXLE

212. Description and Data

a. Description. The rear axle is of the semifloating-type and transmits power from the propeller shaft to the rear wheels. The axle with suspension supports the rear-end load on the wheels. The axle consists of a housing which extends the width of the vehicle tread and contains two rear axle shafts, one for each wheel, a set of drive gears, a differential gear train, and brake mechanisms. The differential housing is offset to the right to permit a straight line of drive from the transfer to the differential.

b. Data.

Manufacturer	Spicer Mfg Corp
Model	44-2
Drive gear ratio	5.38:1
Drive	Hotchkiss
Type	semifloating
Differential type	two pinion

213. Coordination With Ordnance Maintenance Unit

Refer to paragraph 2 for information regarding coordination with an ordnance maintenance unit.

214. Organizational Maintenance

The using organization is responsible for the correction of lubricant leakage, provided complete disassembly of the rear axle is not necessary. Keep the mounting bolts tight and replace any damaged axle shafts, wheel hubs, or brake drums. Lubricate differential and wheel bearings as prescribed on lubrication order (par. 66). Report any unusual noise to ordnance maintenance unit.

215. Rear Axle Shafts

a. Removal.

- (1) The removal procedure is the same for the left or right rear axle shafts.
- (2) Place a jack under the rear axle and raise the vehicle until the wheels are clear of the ground. Place safety stands under both ends of the axle outside the spring U-bolts or block axle with solid blocking.
- (3) Remove wheel (par. 256).
- (4) Pry off hub cap, and remove cotter pin, axle shaft nut, and axle shaft washer (fig. 94).

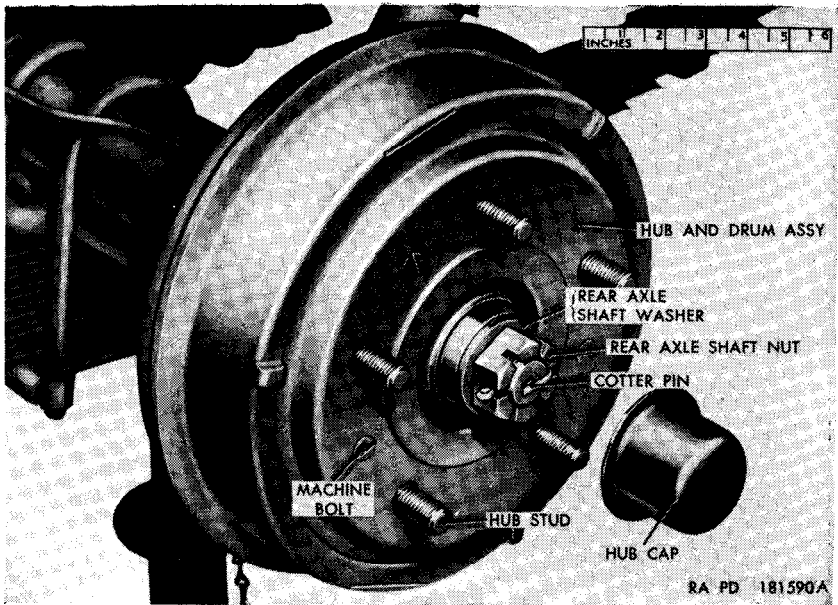

Figure 94. Rear axle assembly—hub cap removed.

- (5) Install a wheel puller on three hub studs of the hub and drum assembly (fig. 94) and remove hub and drum assembly and the key.
- (6) Remove the six plain nuts, lockwashers (fig. 95), and bolts securing the brake grease protector, brake grease

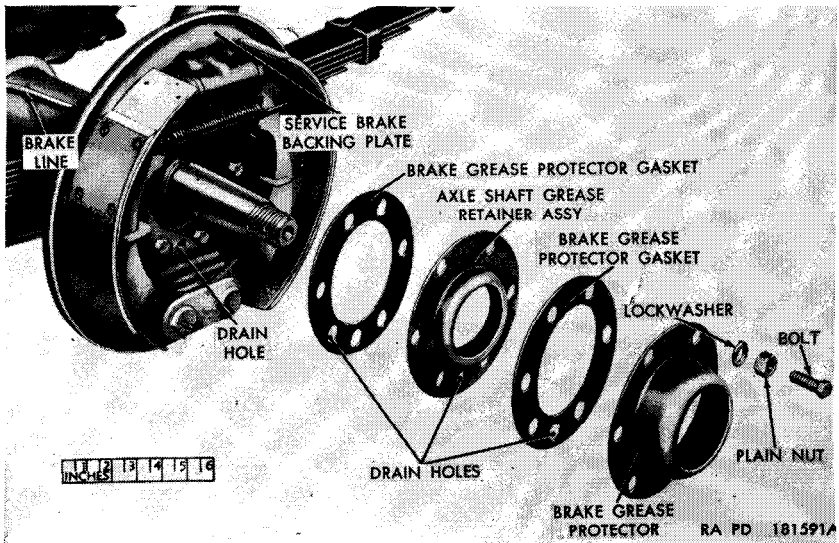

Figure 95. Rear axle assembly—partially exploded view.

protector gaskets, and axle shaft grease retainer assembly to the service brake backing plate and remove the grease protector, gaskets, and grease retainer assembly.

- (7) Unscrew the nut securing the brake line (fig. 95) to service brake backing plate and pull line free. Pull the backing plate with attached brake parts off the axle.
- (8) Remove the bearing retainer and bearing shims from the axle housing flange (fig. 96).

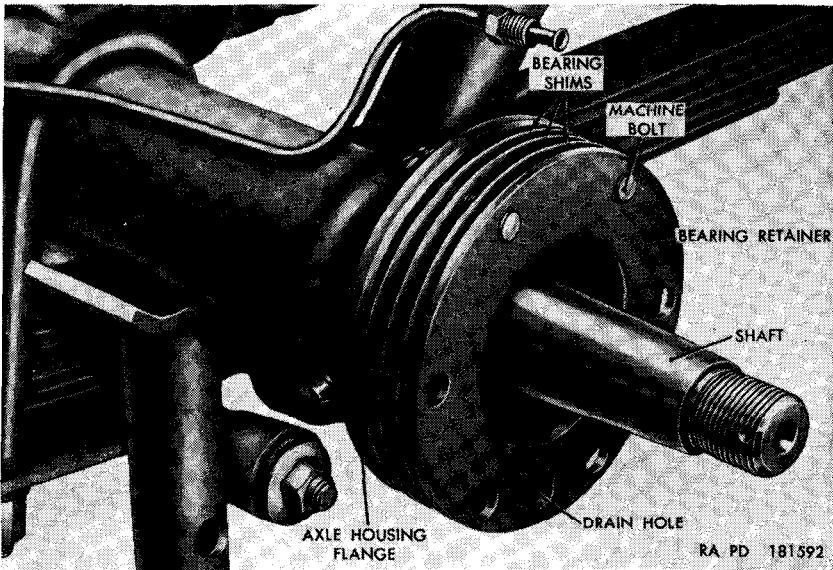

Figure 96. Rear axle shaft, bearing shims, and bearing retainer.

- (9) Withdraw the axle shaft and bearing cup and cone from the axle housing. Pry the inner oil seal out of its seat in the housing.
- (10) Pull the bearing cup off the bearing cone and pull the cone off the axle shaft.

b. Cleaning and Packing. Clean bearing cones with dry-cleaning solvent or volatile mineral spirits. Pack bearing cones (par. 67).

c. Installation.

- (1) Position a new inner oil seal, with the lip facing inward, in the axle housing and carefully tap into place as shown in figure 98. Be sure that the seal is seated on the flange in the housing.

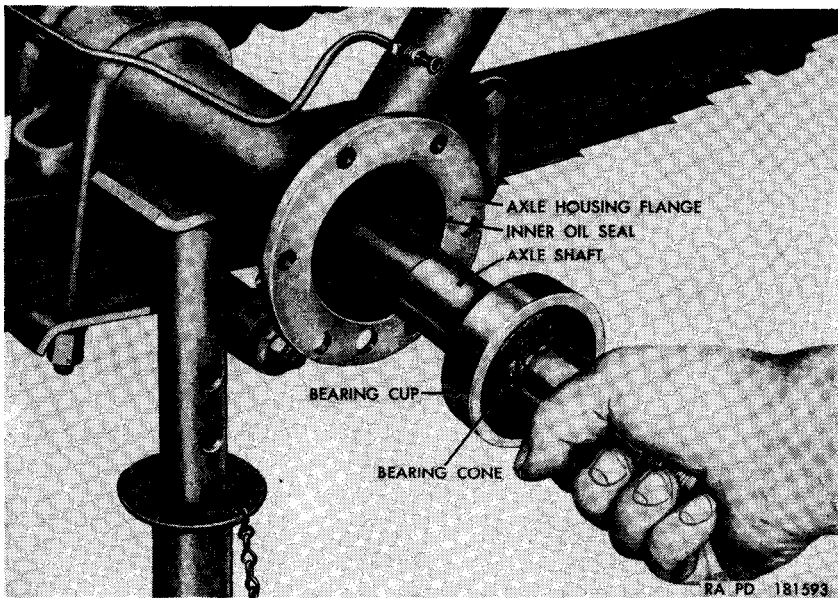

Figure 97. Removing rear axle shaft with bearing cup and cone.

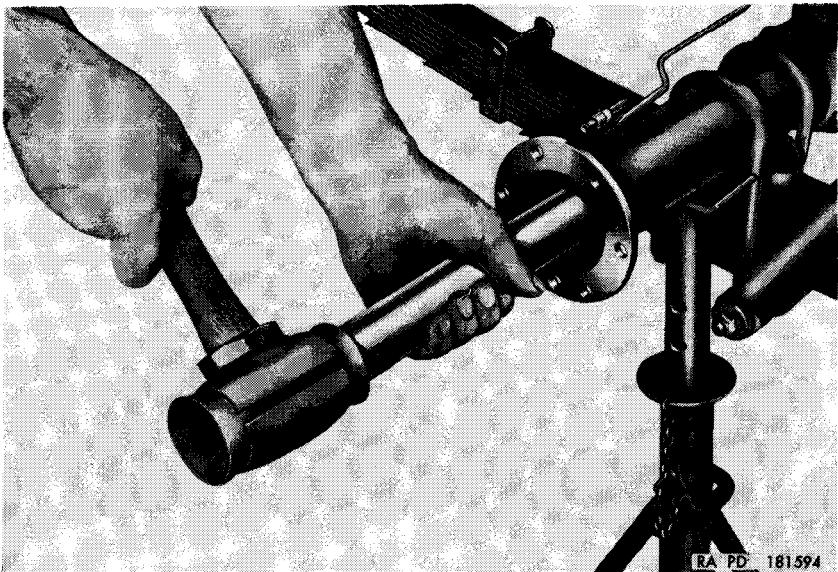

Figure 98. Installing inner oil seal in axle housing.

- (2) Insert the axle shaft into the axle housing and rotate shaft until the spline enters the differential side gear.
- (3) Position the bearing cone on the axle shaft with the small end of the bearing taper facing out. Position the bearing cup over the cone and tap the cup and cone on the axle shaft until the cone seats.

- (4) Position the bearing shims and bearing retainer over the axle shaft, aligning the drain holes in the retainer and shims with the drain hole in the axle housing flange (fig. 96). Insert two of the six $\frac{3}{8}$ x $1\frac{1}{4}$ bolts through the axle housing flange from the inner side and through the shims and retainer to maintain the alignment.
- (5) Position the service brake backing plate and attached brake parts on the axle housing flange and align the drain hole with the drain hole (fig. 95) in the flange.
- (6) Position one brake grease protector gasket, axle shaft grease retainer assembly, second brake grease protector gasket, and the brake grease protector (fig. 95) on the two $\frac{3}{8}$ x $1\frac{1}{4}$ bolts protruding through the backing plate, aligning the drain holes in the gaskets and protector and the drain passage in the retainer with the drain hole in the backing plate.
- (7) Install the four remaining $\frac{3}{8}$ x $1\frac{1}{4}$ bolts through the axle housing flange, and install six $\frac{3}{8}$ -inch lockwashers and $\frac{3}{8}$ -inch plain nuts (fig. 95).
- (8) Position the hub and drum assembly (fig. 94) on the axle shaft and align the keyway in the hub with the keyway in the axle shaft. Insert the key into the keyways and tap key and hub and drum assembly into position on the axle shaft.
- (9) Install the axle shaft washer and axle shaft nut (fig. 94) on the axle shaft. Tighten the nut and secure in position with a $\frac{1}{8}$ x $1\frac{1}{2}$ cotter pin. Position the hub cap (fig. 94) over the axle shaft and tap cap into position on the hub.
- (10) Position the brake line (fig. 95) in its opening in the service brake backing plate and tighten the nut securing the line to the plate.
- (11) Install the wheel (par. 256).
- (12) Remove the safety stands or blocking and lower the wheels to the ground.
- (13) Bleed the brake system (par. 246).

216. Rear Axle Shaft Bearings

a. Adjustment. Place a jack under the axle and raise vehicle until wheels are clear of ground. Test axle shaft end play by grasping wheel and moving in and out. If the bearings are correctly adjusted, end play will be just perceptible. If end play is not correct proceed as shown in (1) through (13) below.

- (1) Unscrew the five nuts and remove the wheel.
- (2) Pry off the hub cap (fig. 94).
- (3) Remove the cotter pin from the axle shaft nut, unscrew the nut, and remove the axle shaft washer (fig. 94).
- (4) Install a puller on three of the hub studs and pull the hub and drum assembly from the axle. Remove the key.
- (5) Unscrew the nut on the end of the brake line from the wheel cylinder. Remove six nuts and lockwashers from the bolts and remove brake grease protector, brake grease protector gasket, axle shaft grease retainer assembly, brake grease protector gasket, and service brake backing plate (fig. 95).
- (6) Pull the bearing retainer (fig. 96) off the bolts and remove or install shims to adjust the axle bearing to provide 0.003- to 0.007-inch end play of the axle shaft.
- (7) Install the bearing retainer (fig. 96) over the shims making sure the drain hole is at the bottom.
- (8) Install the service brake backing plate, brake grease protector gasket, axle shaft grease retainer assembly, brake grease protector gasket, and brake grease protector (fig. 95) in the order named and with drain holes at the bottom and install the six lockwashers and nuts on the bolts.
- (9) Install the key in the axle shaft, and put the hub and drum assembly onto the shaft. Install the axle shaft washer, screw on the axle shaft nut, and install the cotter pin (fig. 94).
- (10) Push the hub cap into place.
- (11) Position the wheel on the hub studs and secure with five nuts.
- (12) Position the brake line in the wheel cylinder and tighten the nut.
- (13) Bleed the brake system (par. 246).

b. Removal. Remove the bearings (par. 215a). Clean and pack bearings (par. 215b).

c. Installation. Install the bearings (par. 215c).

217. Inner Oil Seals

a. Removal. Remove inner oil seal (par. 215a(1) through (9)).

b. Installation. Install inner oil seal (par. 215c).

218. Rear Hubs

a. Removal. Place a jack under axle and raise vehicle until tire is off the ground. Place safety stand under axle at outside

spring U-bolts or block axle with solid blocking. Remove the wheel (par. 256). Pry off the hub cap and remove the cotter pin, axle shaft nut, and axle shaft washer (fig. 94). Install a wheel puller on three hub studs and remove the hub and drum assembly. Remove the key. Remove the three bolts (fig. 94) securing the brake drum to the hub and pull the drum off the hub. If it is necessary to replace any hub studs (fig. 94), drive them out of the hub.

b. Installation. If any hub studs have been removed, drive new studs into hub.

Note. Use studs with left-hand threads in hubs on left side of vehicle, studs with right-hand threads on right side of vehicle.

Position the brake drum on the hub, aligning the mounting holes in the drum with those in the hub. Secure the drum to the hub with three $\frac{1}{4}$ x $\frac{5}{8}$ flat-head bolts (fig. 94). Position the hub and drum assembly on the axle shaft, aligning the keyway in the hub with the keyway in the axle shaft. Insert the key into the keyways and tap the hub and drum assembly and key into position. Install the axle shaft washer and axle shaft nut. Tighten nut and secure in position with a $\frac{1}{8}$ x $1\frac{1}{2}$ cotter pin (fig. 94). Position hub cap (fig. 94) over axle shaft and tap onto hub. Install the wheel (par. 256). Remove safety stands or blocking and lower vehicle to ground.

219. Rear Brake Drums

a. Removal. Remove wheel (par. 256). Pry off the hub cap and remove the cotter pin, axle shaft nut, and axle shaft washer (fig. 94). Remove the three bolts (fig. 94) securing the brake drum to the hub and pull the drum off the hub.

b. Installation. Position the brake drum on the hub, aligning the mounting holes in the drum with those in the hub. Secure the drum to the hub with three $\frac{1}{4}$ x $\frac{5}{8}$ flat-head bolts (fig. 94). Position the axle shaft washer on the axle shaft, install the axle shaft nut and secure nut in position with a $\frac{1}{8}$ x $1\frac{1}{2}$ cotter pin (fig. 94). Position the hub cap (fig. 94) over the axle shaft and tap cap onto hub. Install wheel (par. 256). Lower vehicle to ground and remove jack.

220. Rear Axle Assembly

a. Removal.

- (1) Place a jack under the rear axle and lift the vehicle. Install suitable blocking under frame side rails in front of the rear springs. Leave the jack in position to support the axle during removal.

- (2) Remove both rear wheels (par. 256).
- (3) Unscrew the nut that secures the flexible line (W, fig. 117) to the rear axle tee. Remove the clip that secures the end of the flexible line to the bracket on the frame cross member.
- (4) Disconnect the universal joint from the rear axle (par. 209b).
- (5) Loosen the four U-bolt nuts on the two U-bolts securing the U-bolt plate to the axle housing. Remove nuts, lockwashers, and U-bolts. Swing the lower end of the shock absorber, with U-bolt plate, toward the front of the vehicle. Repeat procedure on other side of vehicle.
- (6) Remove spring shackles from both spring assemblies (par. 250), and lower ends of springs to the ground.
- (7) Remove axle from rear of vehicle.
- (8) If required, remove all brake lines, connections, and fittings from the axle assembly (par. 245).

b. Installation. Any parts not supplied with the new axle should be removed from old axle.

- (1) If necessary, install all brake lines, connections, and fittings on the axle assembly (par. 245).
- (2) Position the axle assembly between the rear springs and frame.
- (3) Raise the ends of the springs, making certain that each spring center bolt enters the recess in the spring saddle. Install spring shackles (par. 250).
- (4) Swing the lower end of one shock absorber, with U-bolt plate, toward the rear and under the axle. Install two U-bolts over housing and through plate and secure with four $\frac{7}{16}$ -inch lockwashers and $\frac{7}{16}$ -inch U-bolt nuts. Repeat on other side of vehicle.
- (5) Connect the universal joint at the rear axle (par. 209d).
- (6) Insert the end of the flexible line (W, fig. 117) through the bracket on the frame cross member. Push the spring clip into the groove on the end of the flexible line. Insert the end of the flexible line into the rear axle tee and tighten the nut.
- (7) Install the wheels (par. 256).
- (8) Remove blocking and lower vehicle.
- (9) Bleed and refill the brake system (par. 246).
- (10) Make a record of replacement on DA Form 478.

Section XXII. FRONT AXLE

221. Description and Data

a. Description. The front axle is a full-floating, Hotchkiss drive-type, with single-reduction hypoid gears transmitting the power from the transfer through constant velocity universal joints to the front wheels. The front axle differential housing is offset to the right to permit a straight line of drive from the transfer to the differential.

b. Data.

Manufacturer	Spicer Mfg Corp
Model	25
Drive gear ratio	5.38:1
Drive type	Hotchkiss
Axle type	full-floating
Differential type	2 pinion
Differential drive gear-type	hypoid
Turning angle	22½ to 25 deg
Lubricant capacity	1¼ qt

222. Coordination With Ordnance Maintenance Unit

Refer to paragraph 2 for information on coordination with an ordnance maintenance unit.

223. Organizational Maintenance

The using organization is responsible for the maintenance and/or replacement of filler or drain plugs, steering knuckle flange oil seals, vent valves, axle shaft assemblies, correct lubrication at proper intervals (par. 66), and tightening of mounting bolts. Any unusual noise should be reported to the ordnance maintenance unit.

224. Front Axle Shafts

a. Removal.

- (1) The removal procedures contained in this paragraph apply to either left or right axle shaft assemblies.
- (2) Place the front wheels in the straight ahead position.
- (3) Place a jack under the front axle and raise the vehicle until the tires clear the ground. Place safety stands or suitable blocking under the axle to support the weight of the vehicle.
- (4) Pry off the hub cap and remove the six screws and lock-washers securing the shaft drive flange to the hub (fig. 99).

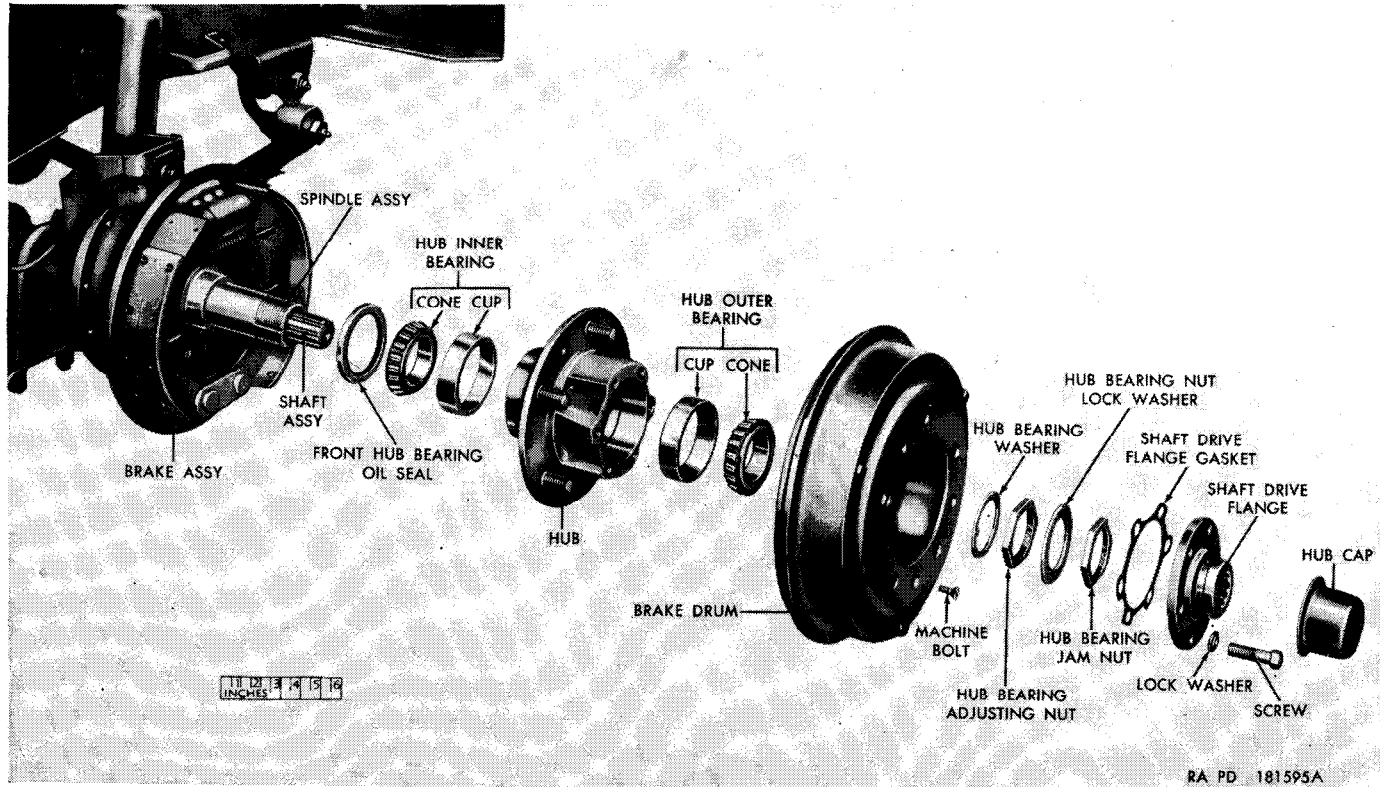

Figure 99. Front axle assembly—partially exploded view.

- (5) Install a suitable puller over the lip of the shaft drive flange and pull the flange off the axle shaft assembly. Separate the shaft drive flange gasket from the shaft drive flange (fig. 99).
- (6) Remove the wheel (par. 228).
- (7) Remove the brake drum (par. 228).
- (8) Straighten the lip of the hub bearing nut lockwasher (fig. 99) to clear the hub bearing jamnut (fig. 99). Position wheel bearing nut wrench 41-W-3825-200 (fig. 100) on the jamnut and unscrew the nut from the spindle assembly (fig. 99). Slide the bearing nut lockwasher (fig. 99) off the spindle assembly.

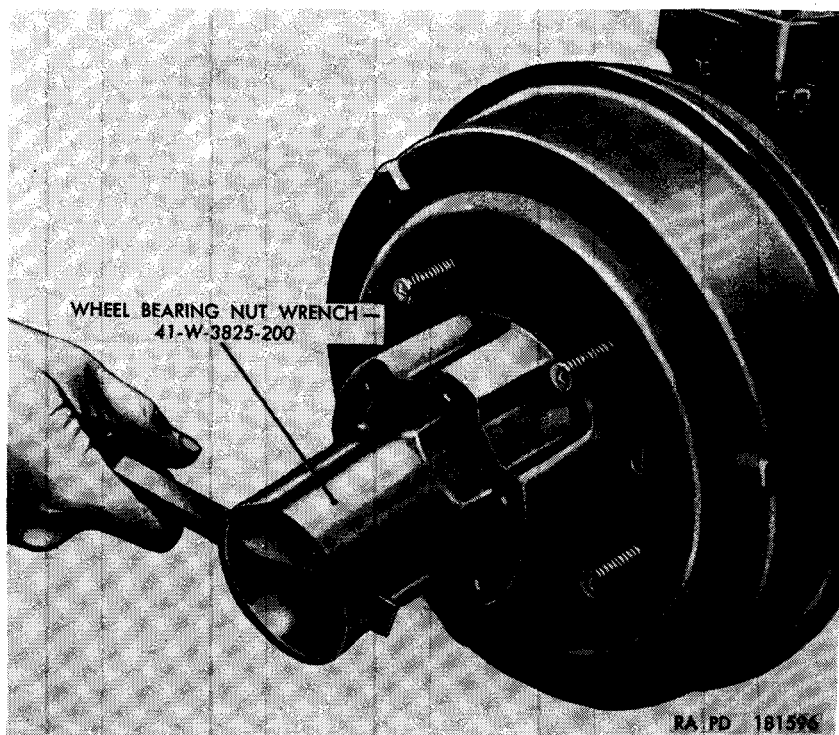

Figure 100. Removing front hub bearing jamnut.

- (9) Position the wheel bearing nut wrench 41-W-3825-200 (fig. 100) on the hub bearing adjusting nut and unscrew the nut from the spindle assembly. Slide the hub bearing washer off the spindle assembly (fig. 99).

- (10) Pull the hub from the spindle assembly. Lift the hub outer bearing cone out of the hub (fig. 99). The hub outer bearing cup will remain in the hub.

Note. It is not necessary to remove the hub inner bearing or hub bearing oil seal to replace the axle shaft assembly.

- (11) Unscrew the nut of the front wheel cylinder line (fig. 101) from the wheel cylinder assembly.
- (12) Remove the six bolts and lockwashers securing the brake assembly and spindle assembly to the steering knuckle flange with arm assembly (fig. 101) and pull the brake off the spindle.
- (13) Pull spindle (fig. 101) from steering knuckle.
- (14) Pull the shaft with universal joint assembly out of the axle housing.

b. Installation.

- (1) Insert the shaft with universal joint assembly through the steering knuckle flange with arm assembly (fig. 101) and into the axle housing. Rotate the shaft until the splines on the shaft enter the differential side gear. With a soft mallet, tap axle shaft into axle housing until it seats.
- (2) Position the spindle assembly (fig. 101) on the shaft, align the spindle mounting holes with the mounting holes in the steering knuckle flange and tap the spindle into position against the flange.
- (3) Position the brake assembly on the shaft, align the mounting holes in the brake with the mounting holes in the spindle and press brake against the spindle. Secure the brake and spindle to the steering knuckle flange with six $\frac{3}{8}$ -inch lockwashers and $\frac{3}{8} \times 3\frac{3}{4}$ bolts (fig. 101).
- (4) Position the hub (fig. 99) on the spindle. Insert the hub outer bearing cone (fig. 99) into the hub, with the small end of the bearing taper facing toward the vehicle. Slide the hub and bearing on the spindle until hub seats against the spindle shoulder. Work the hub up and down on spindle and, at the same time, press bearing cone into position in hub.
- (5) Position the brake drum on the hub with the bolt holes in the drum and hub aligned. Install the three $\frac{1}{4} \times \frac{5}{8}$ bolts (fig. 99).
- (6) Position hub bearing washer on the spindle shaft, aligning the tang on the washer with the slot in the shaft, and slide washer onto shaft. Screw hub bearing adjusting nut (fig. 99) onto the spindle shaft fingertight.

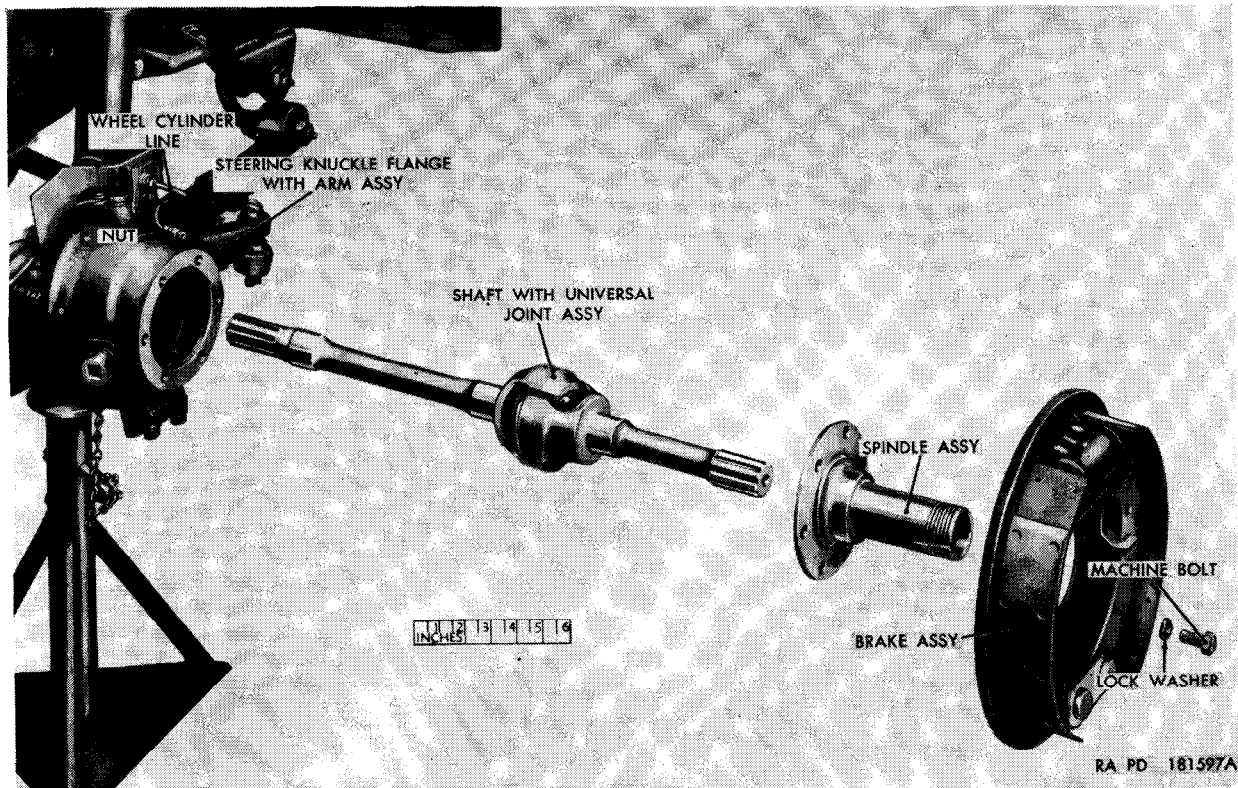

Figure 101. Front axle shaft, spindle, and brake assemblies—partially exploded view.

(7) Position the hub bearing nut wrench 41-W-3825-200 (fig. 98) over the hub bearing adjusting nut and tighten nut. Rotate wheel in alternate directions while taking up on adjusting nut until a bind is noted in wheel rotation. Back off adjusting nut $\frac{1}{6}$ to $\frac{1}{4}$ turn or sufficiently to allow free rotation. Lock adjustment in this position.

Caution: Insure that brakes are completely released and that shoes are not rubbing on brake drum.

- (8) Position the hub bearing nut lockwasher on the spindle shaft, alining the tang on the washer with the slot in the shaft, and slide washer onto shaft. Screw hub bearing jamnut (fig. 97) on the spindle shaft and tighten with wheel bearing nut wrench 41-W-3825-200 (fig. 100). Bend lip of lockwasher over wheel bearing housing adjusting and jamnuts.
- (9) Apply a little grease to the gasket surface of the shaft drive flange. Position a new shaft drive flange gasket (fig. 99) on the drive flange, alining the mounting holes in the gasket with the mounting holes in the flange.
- (10) Position the shaft drive flange and gasket on the shaft assembly, alining the splines in the flange with the splines in the shaft. With a soft mallet, tap flange and gasket part way onto the shaft. Rotate the hub and drum until the mounting holes in the drive flange aline with the mounting holes in the hub. Tap drive flange completely onto shaft and secure to hub with six $\frac{3}{8}$ -inch lockwashers and $\frac{3}{8} \times 2\frac{1}{2}$ screws (fig. 99).
- (11) Screw the nut of the front wheel cylinder line (fig. 101) into the wheel cylinder assembly.
- (12) Position the hub cap over the shaft drive flange and tap into position.
- (13) Install wheel (par. 228).
- (14) Remove the safety stands or blocking and lower vehicle to ground.
- (15) Bleed brakes (par. 246).

225. Front Hub Bearings

a. Adjustment. Adjust front hub bearings by following directions given in paragraphs 224a and b.

b. Removal.

- (1) Perform the operations outlined in paragraph 224a.
- (2) Lift the hub outer bearing cone (fig. 99) out of the hub.
- (3) Remove the hub inner bearing cone and drive the hub bearing oil seal (fig. 99) out of the hub.

- (4) Position remover and replacer 41-R-2374-845 and screw 41-S-1047-330 (fig. 102) in the hub and drive out hub inner bearing cup. Reverse the hub, position remover and replacer 41-R-2374-845 and screw 41-S-1047-330 in hub and drive out hub outer bearing cup.

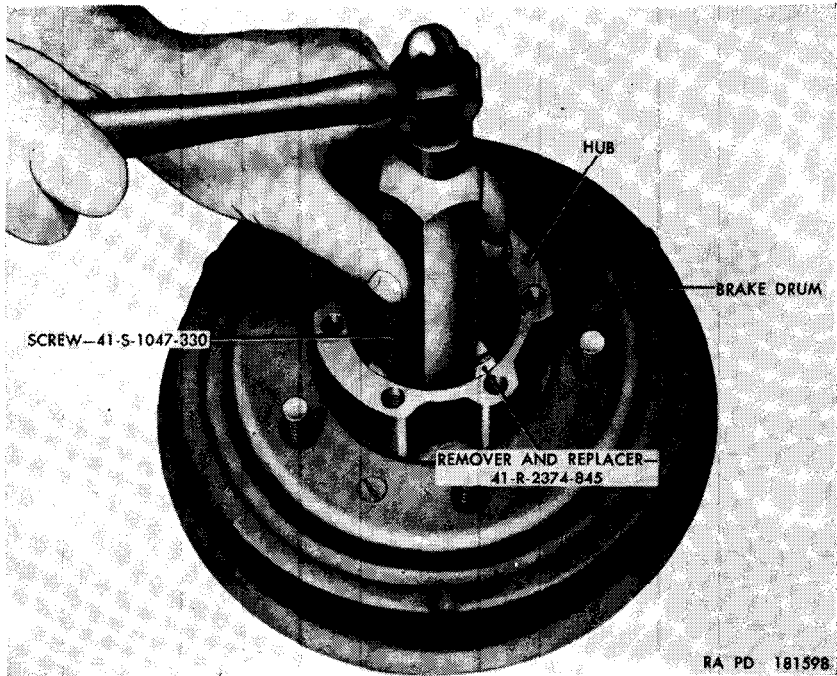

Figure 102. Removing front hub bearing cup with remover and replacer 41-R-2374-845 and screw 41-S-1047-330.

c. Cleaning and Packing. Clean all lubricant from front hub inner and outer bearing cups and cones with dry-cleaning solvent or volatile mineral spirits. Pack bearing cones (par. 67).

d. Installation.

- (1) Position the hub outer bearing cup (fig. 99) in the brake drum side of the hub. Install the remover and replacer 41-R-2374-845 and screw 41-S-1047-330 (fig. 102) in the hub and drive cup into position.
- (2) Position the hub inner bearing cup (fig. 99) in the brake assembly side of the hub. Install the remover and replacer 41-R-2374-845 and screw 41-S-1047-330 (fig. 102) in the hub and drive cup into position.
- (3) Position the hub inner bearing cone (fig. 99) in the hub with the small end of the bearing cone taper facing toward the brake drum.

- (4) Place a new hub bearing oil seal (fig. 99) in the brake assembly side of the hub (fig. 99) with the lip of the seal facing the hub inner bearing cone. With a soft mallet, tap the seal into the hub until it is flush with the hub.
- (5) Perform operations as outlined in paragraph 224b.

226. Front Hubs

a. Removal.

- (1) Follow the procedures given in paragraph 224a(2) through (10).
- (2) Remove the hub inner and outer bearings (par. 225b(2)–(4)). Clean and pack bearings (par. 225c).

b. Installation. Install the hub inner and outer bearings (par. 225d(1)–(4)). Install the hub as outlined in paragraph 224b.

227. Front Hub Bearing Oil Seal

a. Removal. Remove the hub as outlined in paragraph 224a. Drive the oil seal out of the inside end of the hub.

b. Installation. Drive the oil seal into the inside end of the hub with the lip of the seal facing the bearing cone. Install the hub as outlined in paragraph 224b.

228. Brake Drums

a. Removal. Jack up the vehicle until the tire clears the ground. Remove the five hub nuts (nuts on left wheels are threaded left hand and those on right wheels are threaded right hand). Pull the wheel off the hub and studs. Unscrew the three bolts (fig. 99) and pull the drum from the hub.

b. Installation. Position the brake drum on the hub with the bolt holes in the drum and hub alined. Install the three $\frac{1}{4} \times \frac{5}{8}$ bolts. Put the wheel in place over the hub and studs and install five $\frac{1}{2}$ -inch nuts (nuts on left wheels are threaded left hand and nuts on right wheels are threaded right hand).

229. Steering Knuckle Flange Oil Seal Assembly

a. Removal (fig. 103). Place a jack under the front axle and raise vehicle until the tire clears the ground. Remove the eight screws and lockwashers securing the two halves of the steering knuckle flange oil seal assembly to the steering knuckle assembly. Pull the two halves of the oil seal, with the front axle shaft assembly identification plate (fig. 5) and steering knuckle flange oil seal gasket off the steering knuckle flange.

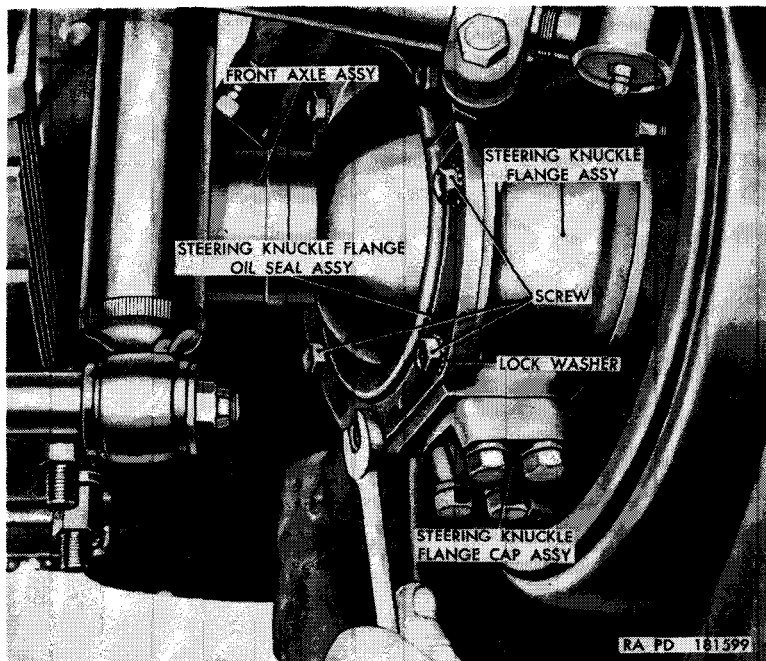

Figure 103. Removing steering knuckle flange oil seal.

b. Installation (fig. 103). Apply a little grease to the gasket surface of the steering knuckle flange assembly. Position a new steering knuckle flange oil seal gasket on the steering knuckle flange and align the mounting holes in the gasket with those in the flange. Position the two halves of the steering knuckle flange oil seal on the flange and secure in position with eight $\frac{5}{16}$ -inch lockwashers and $\frac{5}{16} \times \frac{5}{8}$ screws, positioning the front axle shaft assembly identification plate (fig. 5) on the upper section. Lower vehicle to ground and remove jack.

230. Steering Knuckle Flange Cap Bearings

a. Removal.

- (1) Remove the front axle shaft assembly (par. 224a).
- (2) Withdraw the cotter pin and unscrew the nut securing the steering tie rod end (fig. 104) to the steering knuckle arm.
- (3) Unscrew the nut securing the line between the front tee and the front brake flexible line (fig. 104) to the flexible line.
- (4) Remove the two bolts and lockwashers securing the front brake flexible line guard to the flange cap and remove guard and front brake flexible line (fig. 104).

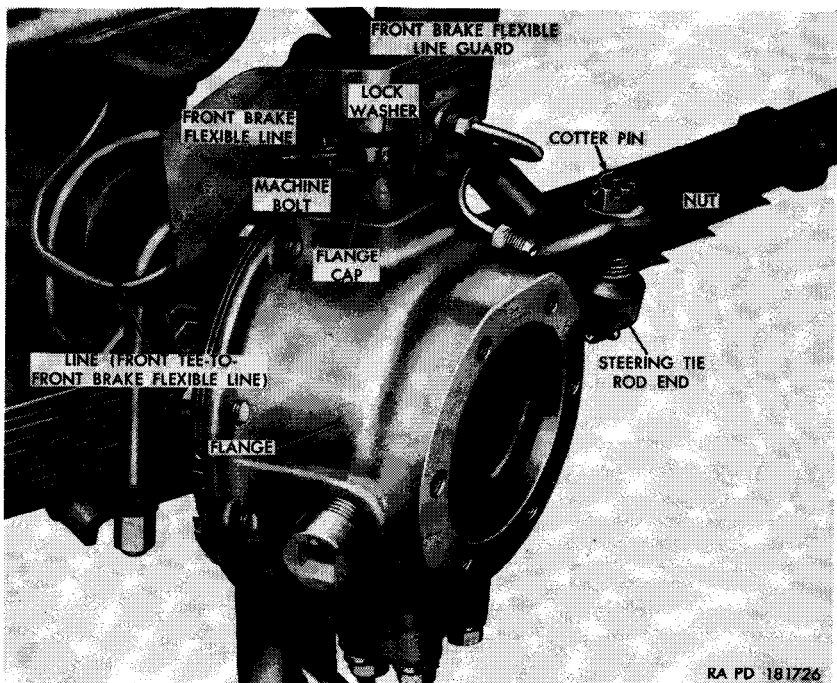

RA PD 181726

Figure 104. Steering knuckle flange with arm assembly.

- (5) Remove the two remaining bolts and lockwashers securing the steering knuckle flange cap in position and pry the cap and shims (fig. 105) out of the steering knuckle flange.
- (6) Remove the four bolts and lockwashers securing the (lower) steering knuckle flange cap in position and pry the cap out of the steering knuckle flange (fig. 105).
- (7) Remove the steering knuckle flange oil seal assembly (par. 229a).
- (8) Pull the steering knuckle flange off the front axle housing and steering tie rod end.
- (9) Lift one steering knuckle flange cap bearing cone out of the steering knuckle flange and the other cone out of the front axle housing.
- (10) Position the remover and replacer 41-R-2374-750 and screw 41-S-1047-300 (fig. 106) in the front axle housing and drive the steering knuckle flange cap bearing cup out of the housing. Remove the lower steering knuckle flange cap bearing cup in the same manner.

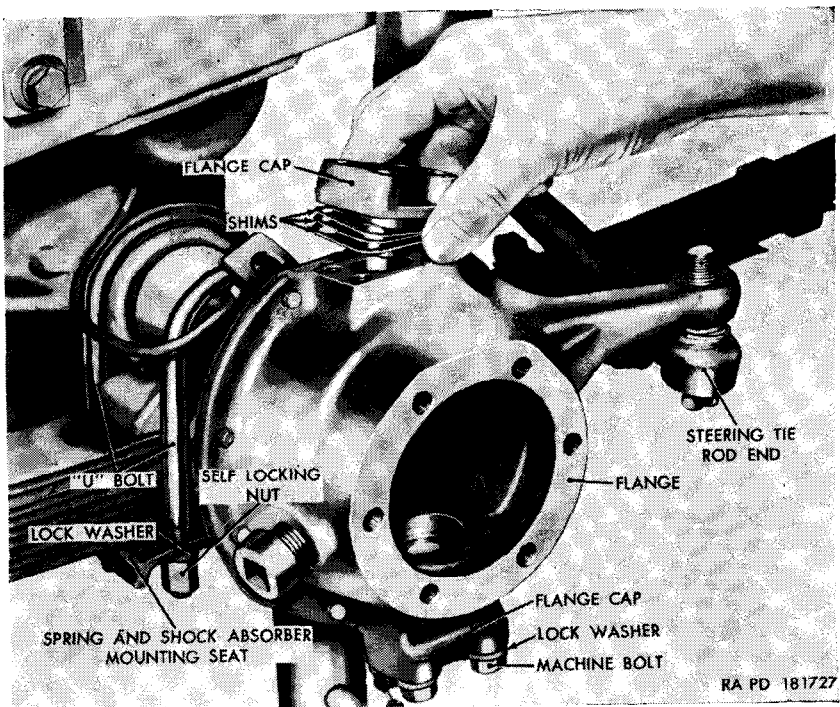

Figure 105. Removing steering knuckle flange cap from steering knuckle flange with arm assembly.

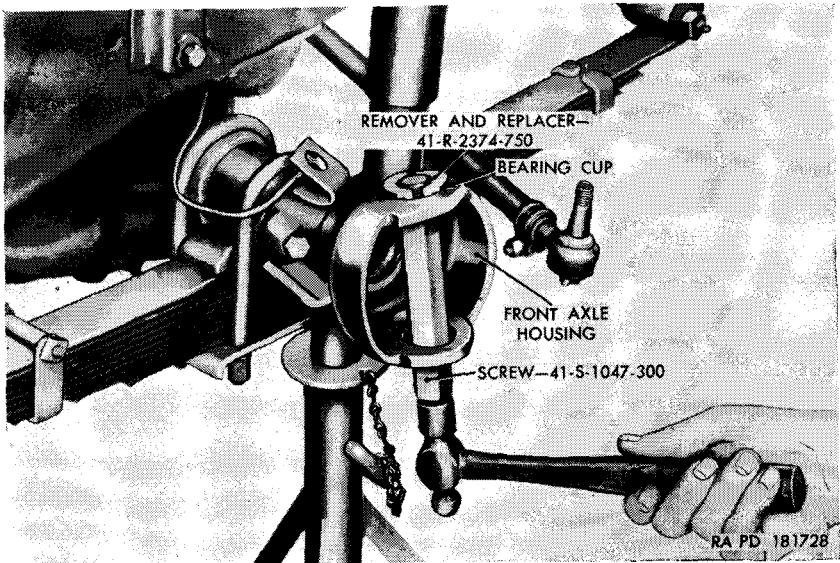

Figure 106. Removing steering knuckle flange cap bearing cup from front axle housing with remover and replacer 41-R-2374-750 and screw 41-S-1047-300.

b. Cleaning and Packing. Clean the steering knuckle flange cap bearing cups and cones with dry-cleaning solvent or volatile mineral spirits. Pack bearing cones with the grease prescribed on lubrication order (par. 66). If a bearing packer is not available, work grease into cones by hand. Keep cones and grease clean.

c. Installation.

- (1) Position a steering knuckle flange cap bearing cup in upper section of the front axle housing with the small end of the bearing taper facing down. Place the remover and replacer 41-R-2374-750 (fig. 106) in the bearing cup. Install the screw 41-S-1047-300 (fig. 106) in the remover and replacer and drive the bearing cup into the housing until upper edge of cup is flush with housing.
- (2) Position a steering knuckle flange cap bearing cup in the lower section of front axle housing with small end of bearing taper facing up. Place the remover and replacer 41-R-2374-750 (fig. 106) in the cup. Install the screw 41-S-1047-300 (fig. 106) in the remover and replacer and drive the cup into the housing until the upper edge of the cup is flush with the housing.
- (3) Position a steering knuckle flange cap bearing cone in its cup in the upper section of the housing. Position the steering knuckle flange arm (fig. 104) on the stud of the tie rod end and swing the flange into position on the housing. Tilt the flange up and slide the second steering knuckle flange cap bearing cone in from the rear of the flange and between the flange and housing. Seat the bearing cones in their cups by working the flange up and down.
- (4) Insert one steering knuckle flange cap up through the lower section of the steering knuckle flange (fig. 105). Secure the cap to the flange with four $\frac{3}{8}$ -inch lockwashers and $\frac{3}{8}$ x $1\frac{1}{2}$ bolts.
- (5) Insert a steering knuckle flange cap and shims (fig. 105) into the upper section of the steering knuckle flange. Secure the cap to the flange with two $\frac{3}{8}$ -inch lockwashers and $\frac{3}{8}$ x $1\frac{5}{8}$ bolts, in the two outside holes. The thickness of shims must be adjusted until vertical movement of the flange is eliminated and there is only slight drag when the flange is turned.

- (6) Position the front brake flexible line guard (fig. 104) on the steering knuckle flange cap and secure in position with two $\frac{3}{8}$ -inch lockwashers and $\frac{3}{8} \times 1\frac{1}{2}$ bolts.
- (7) Screw the nut on the line between the front tee and the front brake flexible line into the fitting of the front brake flexible line (fig. 104).
- (8) Screw the $\frac{1}{2}$ -inch nut (fig. 104) onto the stud of the steering tie rod end and insert a $\frac{3}{32} \times \frac{7}{8}$ cotter pin through slots in nut and hole in the stud.
- (9) Install the steering knuckle flange oil seal (par. 229b).
- (10) Install front axle shaft assembly (par. 224b).

231. Front Axle Assembly

a. Removal.

- (1) Place a jack under the front axle and raise vehicle until tires clear the ground. Place safety stands or suitable blocking under vehicle frame side rails. Leave the jack in position to support weight of axle during removal procedures.
- (2) Remove front wheels (par. 228).
- (3) Withdraw the cotter pin and unscrew steering tie rod end nut (fig. 104). Tap the stud of the tie rod end out of the steering knuckle arm (fig. 104). Repeat the procedure at the other side of the vehicle.
- (4) Disconnect the two front shock absorbers at the lower end only (par. 253).
- (5) Unscrew the nut on the end of the master cylinder front line assembly (HH, fig. 117) from the front tee-to-master cylinder front line (T, fig. 117). Remove the clip, securing the line to the bracket (S, fig. 117) on the vehicle frame, from the groove in the end of the flexible line.
- (6) Disconnect the lower end of each shock absorber (par. 253a).
- (7) Remove the spring pivot bolts (par. 251). Lower front springs to ground.
- (8) Disconnect the front propeller shaft at the front axle (par. 209a).
- (9) Lower the jack supporting the axle and remove axle from under vehicle.
- (10) If required, remove all brake lines, connections, and fittings (par. 245).

b. *Installation.* Any parts not supplied with a new axle assembly should be removed from the old axle.

- (1) If necessary, install all brake lines, connections, and fittings (par. 245).
- (2) Position the axle on a jack and slide jack and axle into position under front of vehicle. Raise the jack until the front propeller shaft can be connected to front axle. Connect propeller shaft (par. 209c).
- (3) Raise the two front springs into position and install spring pivot bolts (par. 251).
- (4) Place a U-bolt over the axle on each side of the spring.

Note. The two U-bolts for the right front spring are of different sizes. Place the wider U-bolt over the differential housing.

Place the spring and shock absorber mounting seat (fig. 105) over the ends of the U-bolts with the free end of the shaft of the mounting seat forward and pointing outward. Secure with four $\frac{7}{16}$ -inch lockwashers and U-bolt nuts. Repeat the procedure on the other side of the vehicle.
- (5) Push the front tee-to-master cylinder front line (T, fig. 117) through the hole in the bracket (S, fig. 117), on the frame, and insert the clip in the groove on the end of the flexible line securing the line to the bracket. Screw the nut on the end of the master cylinder front line assembly (HH, fig. 117) into the flexible line.
- (6) Connect the lower end of the front shock absorbers to the spring and shock absorber mounting seats following the applicable instructions contained in paragraph 253.
- (7) Tap the stud of the tie rod end up into the steering knuckle arm (fig. 104) and secure in position with a $\frac{1}{2}$ -inch nut and $\frac{3}{32}$ x $\frac{7}{8}$ cotter pin. Repeat the procedure on other side of vehicle.
- (8) Install front wheels (par. 228).
- (9) Remove safety stands and blocking, lower vehicle to the ground and remove jack.
- (10) Lubricate axle as directed on lubrication order (par. 66).
- (11) Bleed the brake system (par. 246).
- (12) Make a record of replacement on DA Form 478.

Section XXIII. STEERING SYSTEM

232. Description and Data

a. Description. The steering system (fig. 107) comprises the steering gear assembly, pitman arm, steering drag link assembly, steering bellcrank assembly, and two steering tie rod with

end assemblies. These units are interconnected, and serve to turn the front wheels as the steering wheel is turned. The steering gear assembly is the cam and twin-pin lever-type, and carries a conventional pitman arm. The drag link is the conventional ball and socket-type, with spring-loaded adjustment. The bellcrank assembly has needle bearings between the bellcrank and bellcrank shaft. The right tie rod assembly connects the bellcrank assembly to the right steering knuckle arm. The left tie rod assembly is fastened to the left tie rod end of the right tie rod assembly, and the left steering knuckle arm.

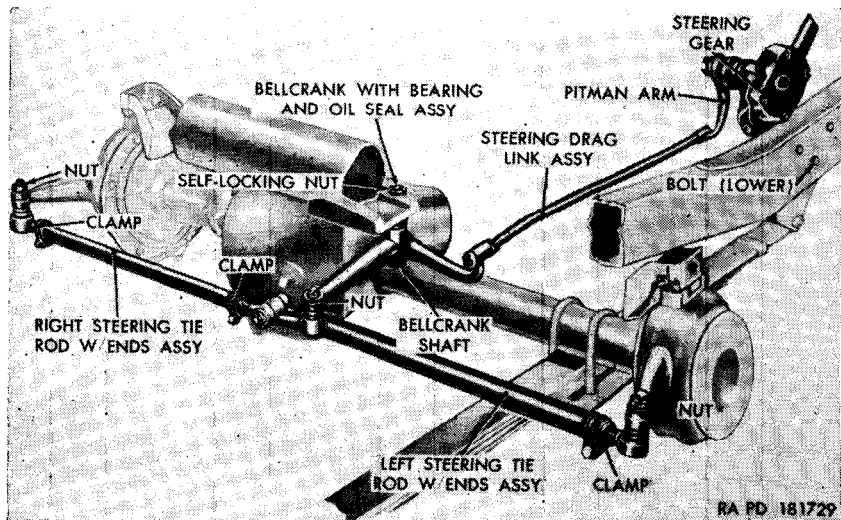

Figure 107. Steering system linkage.

b. Data.

Manufacturer	Ross Gear and Tool Co.
Model	TA 13077
Type	cam and twin-pin lever
Ratio	variable high point-type
Steering geometry:	
King pin inclination	7½ deg
Wheel camber	1½ deg
Wheel caster	3 deg
Wheel toe-in	½ to ⅙ in

233. Organizational Maintenance

Organizational maintenance consists of lubrication (par. 66), periodic inspection (pars. 73-76), and toe-in adjustment (par. 234) as required. Any operation involving correction of steering factors (except toe-in) is the responsibility of the ordnance maintenance unit.

234. Toe-In Adjustment

(figs. 107, 108, and 109)

Loose wheel bearings, worn bushings in steering knuckle supports, damaged wheels and bent steering knuckles, a bent axle housing, or a bent or improperly adjusted tie rod will effect toe-in. Inspect and correct any damaged units found.

a. Inflate tires to correct pressure (par. 254), and check for proper wheel bearing adjustment. With the vehicle on a smooth, level surface, turn the steering wheel until the steering bellcrank is at right angles with the front axle. Place straight-edge or line against outside of left wheels; check to see if left front wheel is in line with or straightahead of the left rear wheel. If left front wheel is not straightahead, loosen the two nuts and screws securing the left tie rod and clamp (fig. 110), and turn tie rod to obtain straightahead position.

Note. Tie rod end on right side of vehicle has left-hand threads; the one on the left side has right-hand threads.

Repeat same operation to check right front wheel; use right tie rod to adjust right front wheel.

b. After both wheels are at straightahead position, place toe-in adjustment gage (fig. 108) between the wheels ahead of the axle, with the ends of the gage bearing against the tire side walls and with both pendant chains just touching the ground. Set gage so that pointer registers zero. Move the vehicle forward until gage is brought into position in back of the axle (fig. 109), with both pendant chains just touching the ground. The pointer will indicate the amount of toe-in or toe-out. Correct toe-in is $\frac{3}{32}$ to $\frac{3}{16}$ inch.

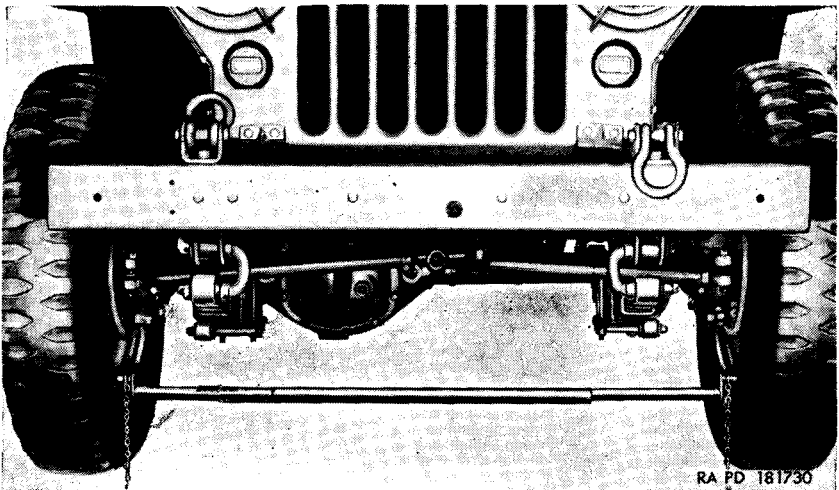

Figure 108. Toe-in gage in place ahead of axle.

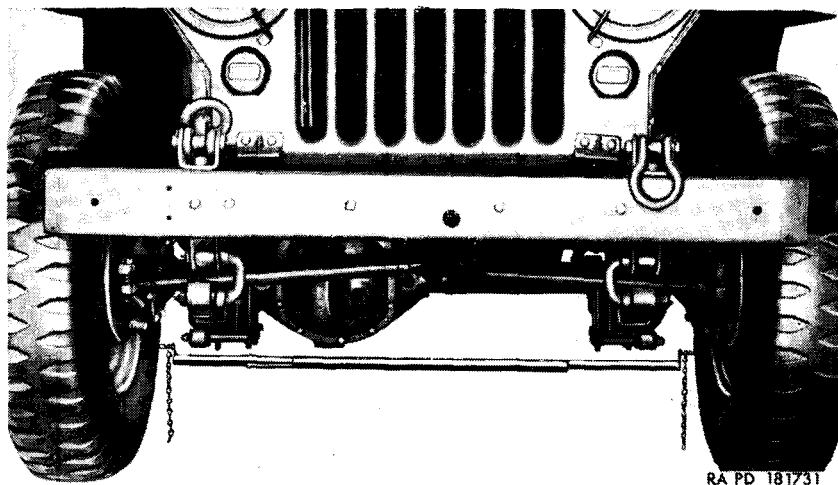

Figure 109. Toe-in gage in place behind axle.

c. If toe-in is not correct, loosen the nut and screw securing the right tie rod end clamp (fig. 110) and turn tie rod to obtain correct adjustment. Make sure that clamp nuts and screws are tightened after adjustment has been made.

235. Steering Tie Rod With Ends Assemblies

(fig. 110)

a. Removal.

- (1) Place the vehicle on a hard level surface and apply the hand brake.
- (2) Remove the cotter pin and nut securing the right end of the left tie rod with ends assembly to the left of the right tie rod with ends assembly.
- (3) Using a suitable puller, separate the two tie rod ends.

Note. Do not hammer on the tie rod ends to separate them.

- (4) Remove the cotter pin and nut securing the left tie rod with ends assembly to the left steering knuckle arm.
- (5) With a suitable puller, separate the tie rod end from the arm and remove the left tie rod with ends assembly.
- (6) Remove the cotter pin and nut securing the right tie rod with ends assembly to the bellcrank.
- (7) Using a suitable puller, separate the right tie rod end from the bellcrank.
- (8) Remove the cotter pin and nut securing the right tie rod with ends assembly to the right steering knuckle arm.
- (9) Using a suitable puller, separate the tie rod end from the arm and remove the right tie rod with ends assembly.

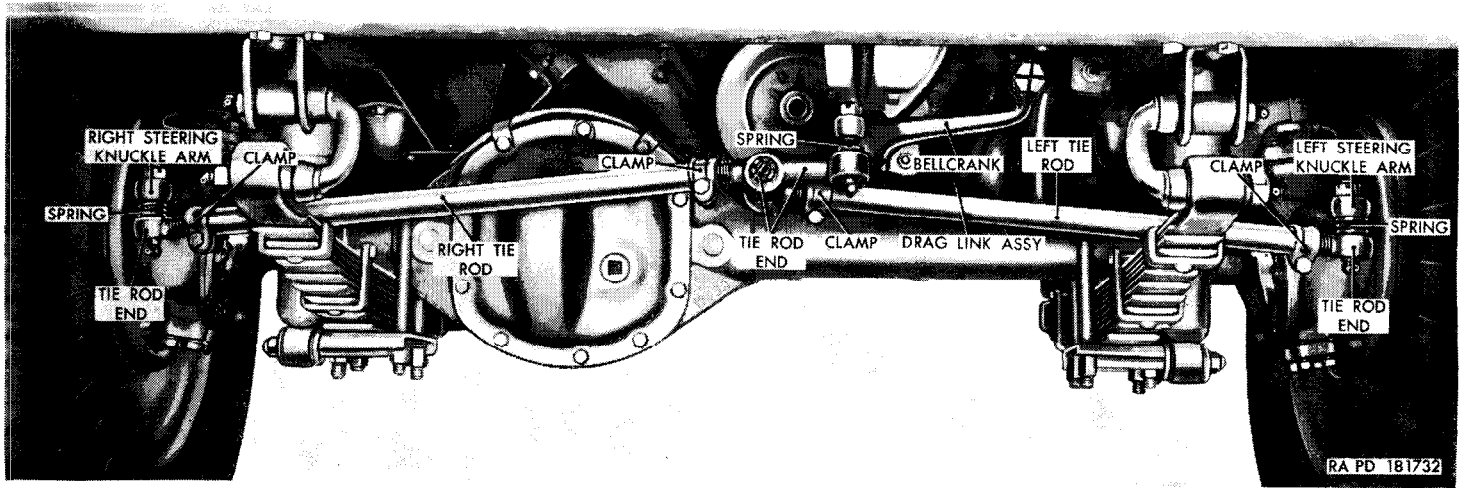

Figure 110. Steering tie rod with ends assemblies and bellcrank with bearing and oil seal assembly installed.

b. Installation.

- (1) Position the right end of the right tie rod with ends assembly in the right steering knuckle arm and secure with a 1/2-inch slotted nut and 3/32 x 7/8 cotter pin.
- (2) Position the left end of the right tie rod with ends assembly in the bellcrank and secure with a 1/2-inch slotted nut and 3/32 x 7/8 cotter pin.
- (3) Position the left end of the left tie rod with ends assembly in the left steering knuckle arm and secure with a 1/2-inch slotted nut and 3/32 x 7/8 cotter pin.
- (4) Position the right end of the left tie rod with ends assembly in the left end of the right tie rod with ends assembly. Secure with a 1/2-inch slotted nut and 3/32 x 7/8 cotter pin.
- (5) Adjust toe-in (par. 234).

236. Steering Tie Rod Ends

(fig. 110)

The right ends of both tie rod with ends assemblies are right hand threaded. The left ends of both tie rod with ends assemblies are left hand threaded. With this exception, the procedures for removal and installation are the same.

a. Removal.

- (1) Remove one end of a tie rod with ends assembly (par. 235a).
- (2) Loosen the nut and screw in the tie rod end clamp and unscrew the tie rod end. Remove the clamp from the end.

b. Installation.

- (1) Place the tie rod end clamp over the tie rod end and screw the end on the tie rod.
- (2) Tighten the nut and screw to secure the clamp.
- (3) Install the tie rod with ends assembly (par. 235b).

237. Steering Drag Link Assembly

Note. The *Key* letters noted in parentheses are in figure 111, except where otherwise indicated.

a. Removal.

- (1) Remove the cotter pin from the axle end of the drag link assembly (fig. 107). Unscrew, but do not remove, the ball seat axle end adjusting plug. Lift the drag link assembly off the ball of the bellcrank.
- (2) Remove the cotter pin from the gear end of the drag link assembly (fig. 107). Unscrew, but do not remove,

the gear end ball seat adjusting plug. Lift the drag link assembly off the ball of the pitman arm.

b. Disassembly.

- (1) Unscrew and remove the axle end ball seat adjusting plug (B). Remove, in order, ball seat (C), ball seat spring (D), and the ball seat spring seat (E).
- (2) Unscrew and remove the gear end ball seat adjusting plug (G). Remove, in order, the ball seat spring seat (E), the ball seat spring (D), and two ball seats (C).
- (3) Remove the dust cover (H) and the dust cover shield (J) from the ball on the pitman arm. Remove the other dust cover (H) and dust cover shield (J) from the ball on the bellcrank.

c. Assembly.

- (1) Install a dust cover shield (J) and dust cover (H) over the ball of the bellcrank and over the ball of the pitman arm.
- (2) Install, in order, in the gear end of the drag link, two ball seats (C), the ball seat spring (D), a ball seat spring seat (E), and an adjusting plug (G).
- (3) Install in the axle end of the drag link, in order, a ball seat spring seat (E), a ball seat spring (D), a ball seat (C), and the axle end ball seat adjusting plug (B).

d. Installation. The ball opening on the axle end of the drag link is closer to the end of the link than is the ball opening on the gear end of the link.

- (1) Position the gear end of the drag link assembly over the ball of the pitman arm, making certain that the ball enters between the two ball seats. Tighten the gear end ball seat adjusting plug. Back off the plug one-quarter turn and until one of the slots is aligned with the holes in the drag link and install a $\frac{1}{8}$ x $1\frac{3}{4}$ cotter pin.
- (2) Position the axle end of the drag link assembly over the ball on the bellcrank, making certain that the ball enters between the ball seat and the ball seat spring. Tighten the axle end ball seat adjusting plug. Back off the plug one-half turn and until one of the slots is aligned with the holes in the drag link and install a $\frac{1}{8}$ x $1\frac{3}{4}$ cotter pin.

238. Steering Bellcrank with Bearing and Oil Seal Assembly

a. Removal.

- (1) Disconnect the right tie rod with ends assembly from the bellcrank (par. 235a(6) and (7)).

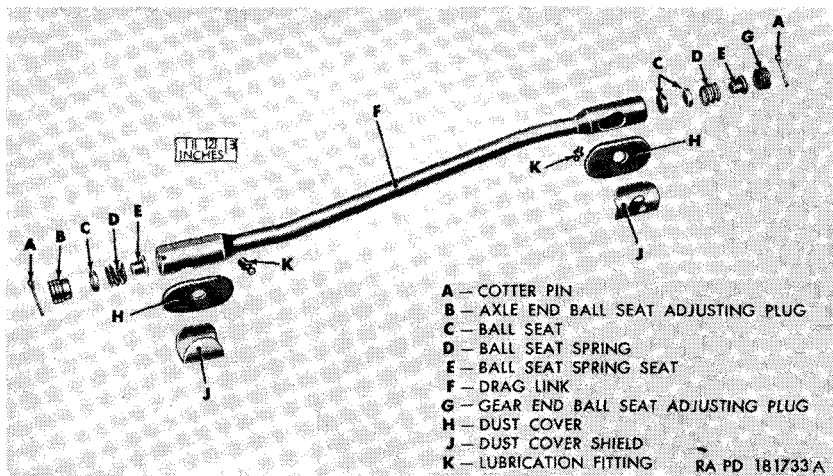

Figure 111. Drag link assembly—exploded view.

- (2) Disconnect the steering drag link assembly from the bellcrank (par. 237a(1)).
- (3) Remove the self-locking nut and plain washer from the top of the bellcrank shaft.
- (4) Loosen the nut and screw in the bellcrank bracket.
- (5) Lower the bellcrank shaft and bellcrank out of the bracket.

Note. The inner race spacer will come out with the shaft.

b. Installation.

- (1) Position the bellcrank assembly against the bellcrank bracket and insert the bellcrank shaft, with inner race spacer, through the bellcrank and bracket.
- (2) Secure the shaft in the bellcrank with a $2\frac{1}{32}$ -inch ID plain washer and $\frac{5}{8}$ -inch self-locking nut.
- (3) Tighten the nut and clamp screw in the bracket.
- (4) Connect the steering drag link assembly to the bellcrank (par. 257d(2)).
- (5) Connect the right tie rod with ends assembly to the bellcrank (par. 235b(2)).
- (6) Lubricate the bellcrank shaft (par. 66).

239. Steering Gear Assembly

a. *Adjustment* (fig. 123). Raise the front end of the vehicle until the wheels are clear of the floor. Remove the steering drag link assembly from the pitman arm (par. 237a(2)). Position the steering wheel in the center of its travel. Loosen the pitman shaft adjusting screw nut. Tighten the pitman shaft adjusting

screw until it is against the seat, and then back the screw out approximately one-half turn and tighten the adjusting screw nut. Mark the steering wheel at the top and place a mark on the windshield in line with the mark on the steering wheel. Turn the steering wheel one-quarter turn to the right. A slight drag should be noticeable, when the steering wheel is turned to the left, as the marks on the wheel and the windshield are alined. Repeat the adjustment operation described above until the slight drag is obtained. Install the steering drag link assembly on the pitman arm (par. 237d). Remove safety stand and lower the vehicle to the floor.

Note. If right front wheel rubs against inner skirt of right front fender, right shoe of chassis frame, and right front chassis lifting hook, reduce turning radius by building up left steering knuckle stop bolt to prevent interference.



Figure 112. Adjusting steering gear.

b. Removal.

- (1) Lift the hood and disconnect the two horn cables by separating the connectors on cables No. 25 (fig. 80). Remove cables from the clips. Unscrew the nut securing the steering wheel and remove the nut and horn button. Remove the steering wheel, using a puller 41-P-2954 and adapter 41-A-18-251 (fig. 113).

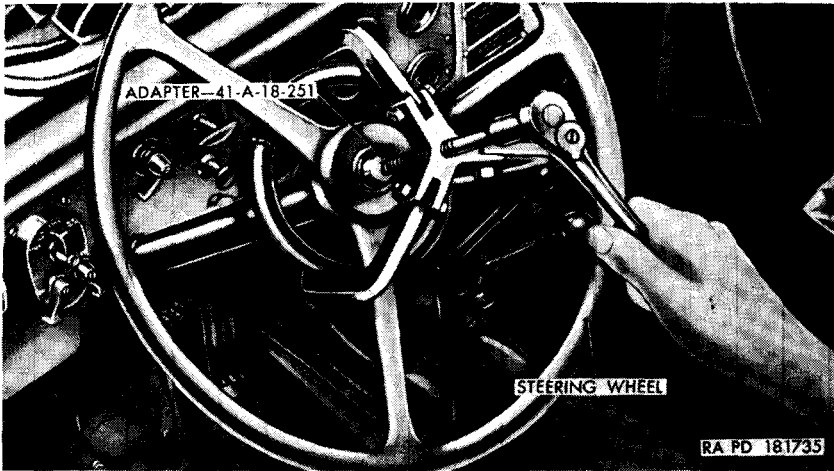

Figure 113. Removing steering wheel.

- (2) Remove the brake pedal pad assembly, the upper front floor pan cover, brake cylinder inspection cover, and steering gear jacket access plate (par. 116e(5)-(7)). Unscrew and remove the accelerator foot rest (F, fig. 35).
- (3) Disconnect the steering drag link assembly from the pitman arm (par. 237a).
- (4) Remove the brake master cylinder-to-dash elbow vent line by unscrewing the connector nuts at the brake master cylinder (K, fig. 117) and at the dash elbow.
- (5) Disconnect cable No. 36 (fig. 87) from the engine oil pressure sending unit.
- (6) Remove two lockwasher screws and nuts securing the steering gear jacket-to-instrument panel mounting clamp and remove the clamp.
- (7) Remove three nuts, internal-external-teeth lockwashers, bolts, and internal-external teeth lockwashers securing the steering gear assembly to the frame left side rail.
- (8) Remove the steering gear assembly through the passenger compartment, moving the lower end from side to side, as required, to clear the pitman arm as the lower end passes the floor pan.
- (9) Remove the nut and lockwasher from the end of the pitman shaft and pull the pitman arm from the shaft.

c. Installation.

- (1) Insert the lower end of the steering gear assembly through the floor pan into position to the right of the frame left side rail.

- (2) Place a $\frac{7}{16}$ -inch internal-external teeth lockwasher onto each of the three $\frac{7}{16}$ x 3 bolts and insert the bolts through the frame left side rail (fig. 112) and the steering gear housing. Secure the three bolts with $\frac{7}{16}$ -inch internal-external teeth lockwashers and $\frac{7}{16}$ -inch nuts.
- (3) Connect the horn cables to the connector on the horn and the connector on cable No. 25 (fig. 80). Place the cables under the clip located on the fender splash shield. Connect cable No. 36 (fig. 87) to the engine oil pressure sending unit.
- (4) Place the brake master cylinder dash elbow-to-dash tee vent line (NN, fig. 117) in position and screw the connector nut into the elbow at the dash. Screw the other connector nut into the master cylinder-to-vent line elbow (MM, fig. 117).
- (5) Place the steering gear jacket-to-instrument panel mounting clamp in position and secure with two $\frac{5}{16}$ x 1 lockwasher screws and nuts.
- (6) With steering wheel at the center of its travel and the wheels in straightahead position, push the pitman arm onto the pitman arm shaft with the ball directly below the shaft. Install the $\frac{3}{4}$ -inch lockwasher and $\frac{3}{4}$ -16-inch nut. Connect the steering drag link assembly to the pitman arm (par. 237b).
- (7) Install the upper front floor pan cover, steering gear jacket access plate, brake cylinder inspection cover, and brake pedal pad assembly (par. 119c(5)-(7)). Install the accelerator foot rest (F, fig. 35).
- (8) Turn the front wheels to the straightahead position. place the steering wheel in position, with one spoke at the top, pointing straight toward the front of the vehicle. Secure the steering wheel with the $1\frac{3}{16}$ -inch nut and install horn button. Adjust the steering gear assembly (par. 239a). Lubricate the assembly as directed on lubrication order (par. 66).

Section XXIV. BRAKE SYSTEM

240. Description and Data

a. Description. The service or foot brake system is of the hydraulic-type with brakes for all four wheels (fig. 117). Each brake has two shoes. Adjustments are provided to compensate for wear of the brake linings. The brake pedal operates a piston in the master cylinder to force brake fluid through the brake

lines to the wheel cylinders which actuate the brake shoes. The hand brake is located at the rear of the transfer and is normally used for holding the vehicle in position when it is parked, but may also be used for stopping the vehicle when in motion in cases of emergency or failure of the service or foot brake. The hand brake handle for operating the brake is located on the left side of the instrument panel. Pulling out on the handle draws a flexible cable through a conduit and actuates the brake shoes of the hand brake.

b. Data.

Service brakes:

Type -----hydraulic
 Size -----9 x 1 3/4
 Fluid capacity -----1/2 pt

Master cylinder:

Type -----reservoir and cylinder
 Size -----1 in

Wheel cylinders:

Type -----straight bore
 Size:
 Front -----1 in
 Rear -----3/4 in

Brake shoes:

Lining length—forward shoe (moulded) --10 7/32 in
 Lining length—rear shoe (moulded) -----6 39/64 in
 Width -----1 3/4 in
 Thickness -----7/32 in

Hand brake:

Type -----mechanical, internal expanding
 Width -----1 3/4 in
 Thickness -----7/32 in

241. Organizational Maintenance

a. Service Brakes. Check the level of the hydraulic brake fluid in the master cylinder (par. 60). Adjust brakes (par. 242). Inspect all brake lines for damage or leaks and replace if necessary (par. 245). Check brake system at intervals as directed in table III.

b. Hand Brake. Be sure that control linkage operates freely at all times. Adjust brake (par. 247). Check brake at intervals as directed in table III.

242. Service Brakes

a. Pedal Adjustment (fig. 114). Adjust brake pedal free travel to one-half inch by adjusting operating length of the eye bolt (D). Loosen the locknut (E) and turn the adjusting nut (F) in

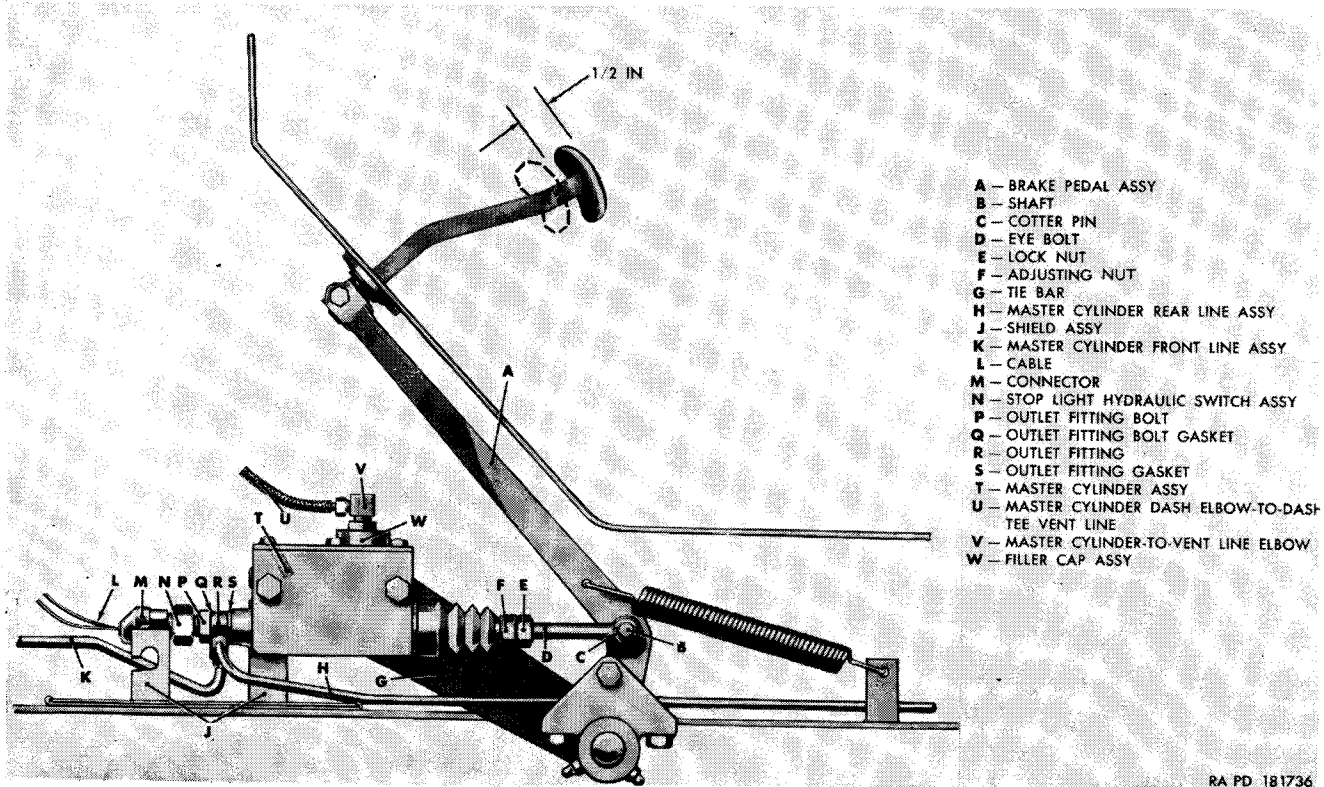

RA PD 181736

Figure 114. Master cylinder assembly, adjustment, lines, and outlet fitting.

the direction necessary to adjust the operating length of the bolt so that the brake pedal free travel will be one-half inch. After pedal free travel has been adjusted, tighten the locknut (E).

b. Brake Adjustment (Minor).

- (1) Raise the vehicle until the tires are clear of the floor and support the vehicle with safety stands. Fill the master cylinder assembly (T, fig. 114) to within one-half inch of top of reservoir.

Note. Do not adjust brakes when brake drums are hot.

- (2) Loosen the nut (fig. 115) on the shoe adjusting eccentric. Place a wrench on the shoe adjusting eccentric so that the wrench extends upward. Rotate the wheel and turn the shoe adjusting eccentric, moving the wrench handle away from the axle until a slight drag of the drum on the brake shoe is felt. Back off the eccentric until drag is no longer felt and the wheel turns freely. Hold the shoe adjusting eccentric in this position with the wrench and tighten the nut. Rotate the wheel again to make sure that the wheel still turns freely. Repeat the operation on the other three wheels. Remove the vehicle from the safety stands.

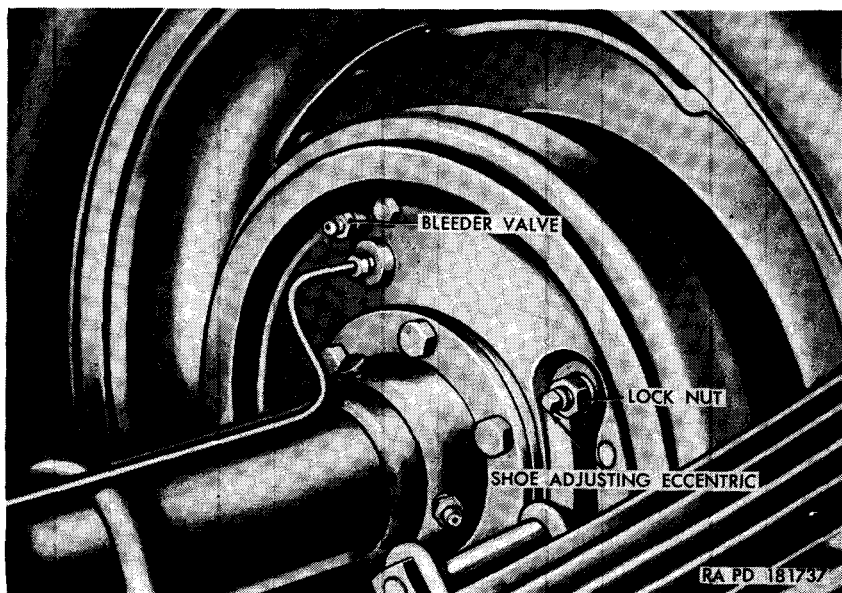

Figure 115. Brake shoe adjusting eccentric and bleeder valve.

c. Brake Shoe Adjustment (Major).

- (1) Remove wheel (par. 237).
- (2) Rotate the brake drum until the slotted opening in the drum is at the lower end of a brake shoe and insert a 0.005-inch feeler gage through the opening between the lining and the drum. If the clearance is greater or less than 0.005-inch, adjust to proper clearance. To adjust the lower end of a shoe, loosen the nut on the shoe anchor pin (fig. 116) on the inner side of the brake backing plate. Turn the shoe anchor pin with a wrench until the proper clearance is obtained. Hold the shoe anchor pin with the wrench and tighten the nut on the anchor pin. Repeat the operation on the second brake shoe and anchor pin.
- (3) Rotate the brake drum until slotted opening in the drum is at the upper end of a brake shoe and insert a 0.008-inch feeler gage through the opening between the lining and the drum. If the clearance is greater or less than 0.008-inch, loosen the nut (fig. 115) on the shoe adjusting eccentric. With a wrench, turn the shoe adjusting eccentric until the proper clearance is obtained. Hold the shoe adjusting eccentric with the wrench and tighten the nut. Repeat the operation on the second brake shoe. Rotate the drum and again check clearances.
- (4) Install wheel (par. 228 or 256).
- (5) Repeat the procedure for the other three wheels.

d. Brake Shoe Removal (fig. 116).

- (1) Remove wheel (par. 256).
- (2) Loosen the nuts (fig. 115) on the two shoe adjusting eccentrics and turn the shoe adjusting eccentrics toward the axle so that the low sides of the eccentrics are against the brake shoes.
- (3) Unscrew the three bolts (fig. 94) from the brake drum and hub and remove the drum.
- (4) Install a brake wheel cylinder clamp over the ends of the wheel cylinder to hold the wheel cylinder pistons in place. Unhook the shoe retracting spring from each brake shoe.
- (5) Unscrew the nuts and remove the lockwashers (on the inner side of the backing plate) from the two anchor pins. Pull the anchor pins out of the backing plate, anchor pin cams in the brake shoe assemblies, and anchor pin plate; remove the plate.

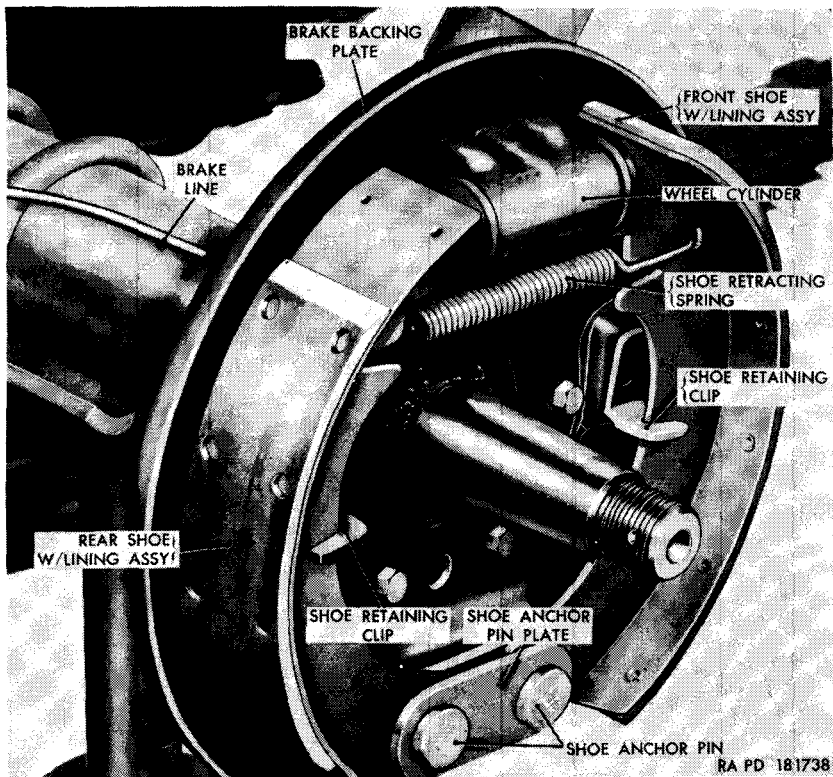

Figure 116. Service brake assembly—brake drum removed (right rear shown).

- (6) Pull the brake shoes out from the wheel cylinder, free from the shoe retaining clips, and remove the shoes from the vehicle.

e. Brake Shoe Installation (fig. 116).

- (1) Position the brake shoes on the backing plate, sliding the shoes into the shoe retaining clips and the wheel cylinder. The shoe with the long lining goes to the front.
- (2) Insert shoe anchor pin cam into the hole in each shoe. Place the shoe anchor pin plate in position over the cams in the shoes. Insert the shoe anchor pins through the plate, cams, and backing plate. Place a lockwasher on each shoe anchor pin on the inner side of the backing plate and screw nut on each pin but do not tighten. Hook the shoe retracting spring into each brake shoe and remove the brake wheel cylinder clamp.
- (3) Position the brake drum on the hub, align the holes in the drum with the holes in the hub, and install the three $\frac{1}{4}$ x $\frac{5}{8}$ bolts.
- (4) Adjust the brakes (*c* above) and install wheels (par. 256).

243. Wheel Cylinder

(fig. 116)

a. Removal.

- (1) Remove wheel (par. 228 or 256).
- (2) Unscrew the three bolts (fig. 94) from the brake drum and hub and remove the drum. Unhook the shoe retracting spring from each brake shoe.
- (3) Unscrew the nut on the end of the brake line from the wheel cylinder on the inner side of the brake backing plate. Unscrew the two lockwasher bolts, on the inner side of the brake backing plate, from the wheel cylinder.
- (4) Pull the upper end of the brake shoes out from the wheel cylinder and remove the cylinder from the vehicle.

b. Installation.

Caution: If all wheel cylinders have been removed, note that the larger cylinders belong on the front wheels.

- (1) Position the wheel cylinder on the inner side of the brake backing plate. Insert two $\frac{1}{4}$ x $\frac{3}{8}$ lockwasher bolts through the backing plate from the inside and screw into the wheel cylinder. Screw the nut on the end of the brake line into the wheel cylinder.
- (2) Push the upper end of the brake shoes into the wheel cylinder and hook the shoe retracting spring into each shoe. Install the brake drum on the wheel hub, align the holes in the drum with the holes in the hub, and install the three $\frac{1}{4}$ x $\frac{5}{8}$ bolts.
- (3) Install the wheel (par. 228 or 256). Bleed the brakes (par. 246). Adjust the brakes (par 242b or c) if necessary. Remove the safety stand, lower the vehicle to the floor and check the nuts on the wheel studs to make sure they are tight.

244. Master Cylinder Assembly

Note. The key letters noted in parentheses are in figure 114, except where otherwise indicated.

a. Removal.

- (1) Loosen the lower bolt (fig. 107) securing the steering gear to the frame and securing the bracket on the shield assembly (J) to the steering gear. Loosen the bolt (AA, fig. 117), on the tie bar (Z, fig. 117) at the front of the master cylinder, from the nut on the master cylinder mounting bracket on the frame side rail. Push the shield up, slide to the rear off the bolts, and remove the shield from the vehicle.

- (2) Unscrew the nut on the end of the master cylinder dash elbow-to-dash tee vent line (U) from the master cylinder-to-vent line elbow (V). Unscrew the nut on the end of the master cylinder front line assembly (K) and the nut on the end of the master cylinder rear line assembly (H) from the outlet fitting (R). Disconnect the cable (L) from the stoplight hydraulic switch assembly (N) by turning the connector (M) on the end of the cable counterclockwise and pulling the connector from the switch. Remove the cotter pin (C) from the shaft (B) on the brake pedal assembly (A) and slide the eye bolt (D) off the shaft.
- (3) Unscrew the bolts (AA, fig. 117) from the nuts on the master cylinder mounting bracket on the frame side rail. Remove the bolt and lockwasher at the front of the master cylinder assembly (T) from the tie bar (G) and the master cylinder. Slide the bolt at the rear of the master cylinder out of the tie bar sufficiently to clear the mounting bracket on the frame side rail, lower the master cylinder with tie bar and remove the bolt and lockwasher from the tie bar and master cylinder. Remove the master cylinder from the vehicle.
- (4) Unscrew the stop light hydraulic switch assembly (N) from the outlet fitting bolt (P). Remove the outlet fitting bolt (P) and remove the outlet fitting bolt gasket (Q), outlet fitting gasket (S), and outlet fitting (R).

b. Installation.

- (1) Position the outlet fitting bolt gasket (Q), the outlet fitting (R), and the outlet fitting gasket (S) on the outlet fitting bolt (P). Install, but do not tighten, outlet fitting bolt (P) in master cylinder assembly. Install stoplight hydraulic switch assembly (N) in outlet fitting bolt (P).
- (2) Position the master cylinder assembly (T) on the tie bar (G). Place a $\frac{3}{8}$ -inch lockwasher over a $\frac{3}{8}$ x 3 bolt and insert the bolt through the hole at the rear of the tie bar and into the hole in the rear of the master cylinder. Raise the master cylinder and tie bar and position the master cylinder on the master cylinder mounting bracket welded to the frame side rail. Screw the bolt into the nut on the bracket but do not tighten. Place a $\frac{3}{8}$ -inch lockwasher over a $\frac{3}{8}$ x 3 bolt and insert the bolt through the hole at the front of the tie bar, through the hole in the master cylinder, and screw the bolt into the nut on the master cylinder mounting bracket but do not tighten.

- (3) Slide the eye bolt (D) onto the shaft (B) on the brake pedal assembly (A) and install the cotter pin (C).
- (4) Screw the nut on the end of the master cylinder front line assembly (K) and the nut on the end of the master cylinder rear line assembly (H) into the outlet fitting (R). Tighten outlet fitting bolt (P). Push the connector (M) on the end of the cable (L) into the stoplight hydraulic switch assembly (N) and turn the connector clockwise, securing it to the switch.
- (5) Install the shield assembly (J) by sliding the inner bracket on the shield over the bolt and between the lockwasher on the bolt and the tie bar at the front end of the master cylinder, and sliding the outer bracket on the shield over the lower bolt (fig. 107) and between the lockwasher on the lower bolt, and the steering gear. Tighten the lower bolt and the two bolts on the tie bar.
- (6) Fill the master cylinder with hydraulic brake fluid and bleed the brakes (par. 246).

245. Solid Lines, Flexible Lines, and Fittings

a. Solid Lines (fig. 114).

- (1) *Line assembly (front wheel cylinder-to-front brake flexible line) (N) (right or left side).*
 - (a) *Removal.* Unscrew the nut at each end of line assembly (N) and remove the line from the vehicle.
 - (b) *Installation.* Position line assembly (N) between the front wheel cylinder assembly (M) and front brake flexible line assembly (Q) and install the nut at each end of the line. Bleed the lines (par. 246).
- (2) *Line assembly (front tee-to-front brake flexible line) (left side).*
 - (a) *Removal.* Unscrew the nut at each end of the line assembly (L) and remove the line from the vehicle.
 - (b) *Installation.* Position the line assembly (L) and install the nut at each end of the line. Bleed the lines (par. 246).
- (3) *Line assembly (front tee-to-front brake flexible line) (right side).*
 - (a) *Removal.* Unscrew the nut at each end of the line assembly (A). Unscrew the two lockwasher bolts holding the two clips (V). Remove the two clamps (U) from the front axle, and remove the line from the vehicle. Do not remove the two clips (V) from the line unless necessary.
 - (b) *Installation.* Install the two clips (V) on the line if

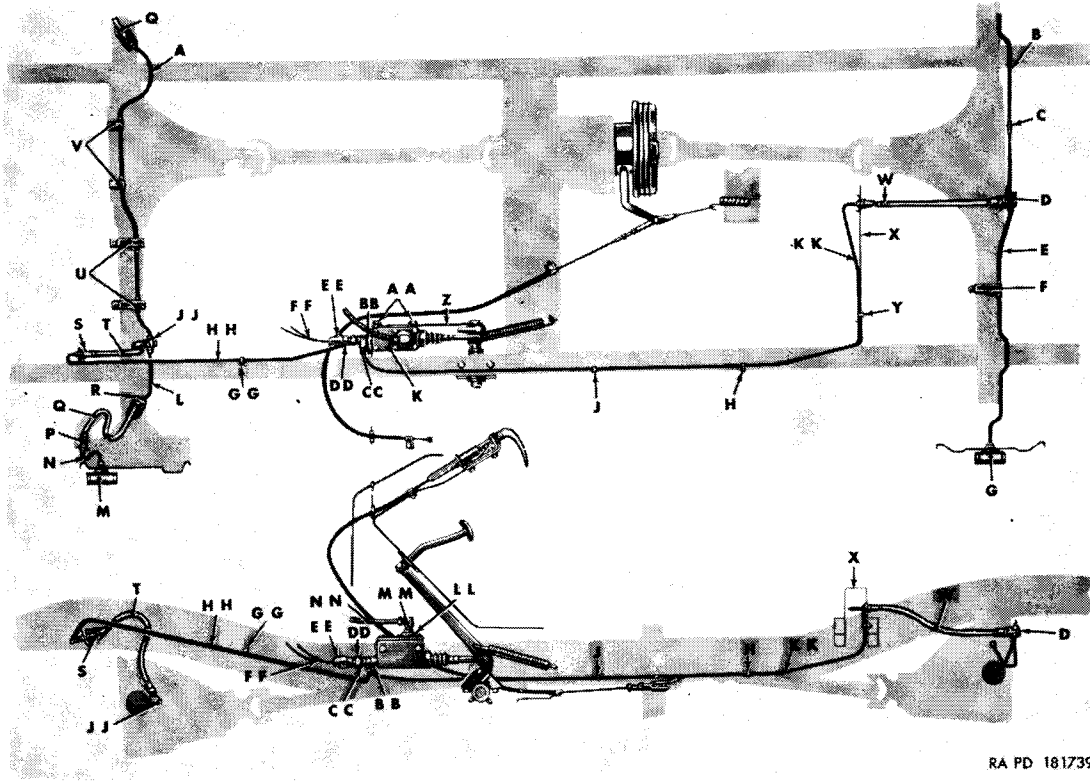

RA PD 181739

Figure 117. Brake system.

A—Line assy (front tee-to-front brake flexible line) (right side)	T—Front tee-to-master cylinder front line
B—Rear tee-to-right wheel cylinder line	U—Clamp
C—Clip	V—Clip
D—Rear axle tee (brake line)	W—Flexible line assy (rear tee-to-master cylinder rear line)
E—Rear tee-to-left wheel cylinder line	X—Frame cross member
F—Clip	Y—Clip
G—Rear wheel cylinder assy	Z—Tie bar
H—Clip	AA—Bolt (tie bar) $\frac{3}{8}$ x 3
J—Clip	BB—Outlet fitting
K—Master cylinder assy	CC—Outlet fitting bolt $\frac{1}{2}$ x $1\frac{15}{32}$
L—Line assy (front tee-to-front brake flexible line) (left side)	DD—Stop light hydraulic switch assy
M—Front wheel cylinder assy	EE—Connector
N—Line assy (front wheel cylinder-to-front brake flexible line)	FF—Cable
P—Front brake flexible line guard	GG—Clip
Q—Front brake flexible line assy	HH—Master cylinder front line assy
R—Bracket	JJ—Front axle tee (brake line)
S—Bracket	KK—Master cylinder rear line assy
	LL—Filler cap assy
	MM—Master cylinder-to-vent line elbow
	NN—Master cylinder dash elbow-to-dash tee vent line

Figure 117—Continued.

they were removed. Position the line assembly (A) between the front axle-tee (JJ) and the front brake flexible line assembly (Q) and install the nuts at each end of the line. Position the two clips (V) over the holes in the front axle cover and fasten in place with $\frac{5}{16}$ x $\frac{5}{8}$ lockwasher bolts. Install the two clamps (U) holding the line to the axle.

Note. With a pair of cutters, shear off the part of each clamp screw that protrudes. This will eliminate the hazard of picking up foreign matter which might eventually entangle the brake line and cause a rupture.

Bleed the lines (par. 246).

(4) *Master cylinder front line assembly.*

(a) *Removal.* Remove the master cylinder shield assembly (par. 244a(1)). Unscrew the nut at each end of the line assembly (HH), remove the line from the clip (GG), and remove the line from the vehicle.

(b) *Installation.* Position the line assembly (HH) between the outlet fitting (BB) and the front tee-to-master cylinder front line assembly (T) and install the nuts at each end of the line. Push the line into the clip (GG). Install the master cylinder shield (par. 244b(5)). Bleed the lines (par. 246).

(5) *Master cylinder rear line assembly.*

(a) *Removal.* Remove the master cylinder shield assembly (par. 244a(1)). Unscrew the nut at each end of the line assembly (KK). Remove the line from the clip

(Y) and the two clips (H and J), and remove the line from the vehicle.

(b) *Installation.* Position the line assembly between the outlet fitting (BB) and the flexible line assembly (rear tee-to-master cylinder rear line) (W) and install the nuts at each end of the line. Push the line into the three clips (H, J, and Y). Install the master cylinder shield assembly (par. 244b(5)). Bleed the lines (par. 246).

(6) *Rear tee-to-left wheel cylinder line.*

(a) *Removal.* Unscrew the nut at each end of line (E). Remove the line from the clip (F) and remove the line from the vehicle.

(b) *Installation.* Position line (E) between the rear axle tee (D) and the rear wheel cylinder assembly (G) and install the nut at each end of the line. Place the line in the clip (F). Bleed lines (par. 246).

(7) *Rear tee-to-right wheel cylinder line.*

(a) *Removal.* Unscrew the nut at each end of line (B). Unscrew the lockwasher bolt holding the clip (C) and remove the line with clip from the vehicle. Do not remove the clip from the line unless necessary.

(b) *Installation.* Install a clip (C) on line (B) if removed. Position the line between the rear axle tee and the right wheel cylinder and install the nut at each end of the line. Aline the clip with the hole in the axle cover and install a $\frac{5}{16}$ x $\frac{5}{8}$ lockwasher bolt. Bleed the lines (par. 246).

b. *Flexible Lines* (fig. 117).

(1) *Front brake flexible line assembly (right or left).*

(a) *Removal.* Unscrew the nut on the end of the line assembly (front wheel cylinder-to-front brake flexible line) (N) from the line assembly (Q). Unscrew the nut on the outside end of the line assembly (front tee-to-front brake flexible line) (A or L) from the inside end of the line assembly (Q). Remove the clip from the groove at each end of the flexible line and remove the line from the vehicle.

(b) *Installation.* Position line assembly (Q) between the bracket (R) on the front axle and the front brake flexible line guard (P). Slide a clip into the groove at each end of the line to secure the line to the bracket and guard. Screw the nut on the line assembly (front wheel cylinder-to-front brake flexible line) (N) onto the flexible line. Screw the nut on the end of the line

assembly (front tee-to-front brake flexible line) (A or L) into the flexible line. Bleed the lines (par 246).

(2) *Front tee-to-master cylinder front line assembly.*

(a) *Removal.* Unscrew the nut on the end of the master cylinder front line assembly (HH) from line assembly (T). Remove the clip from the groove in the end of the flexible line. Unscrew the flexible line from the front axle tee (JJ) and remove the line and copper gasket from the vehicle.

(b) *Installation.* Place the copper gasket on the male end of the line assembly (T) and screw the line into the front axle tee (JJ). Push the other end of the flexible line through the hole in the bracket (S) and slide the clip into the groove near the end of the line. Screw the nut on the master cylinder front line assembly (HH) into the forward end of the flexible line. Bleed the lines (par. 246).

(3) *Flexible line assembly (rear tee-to-master cylinder rear line).*

(a) *Removal.* Unscrew the nut on the end of the master cylinder rear line assembly (KK) from flexible line assembly (W). Remove the clip from the groove in the end of the flexible line. Unscrew the flexible line from the rear axle tee (D) and remove the flexible line and copper gasket from the vehicle.

(b) *Installation.* Place the copper gasket on the male end of the flexible line assembly (W) and screw the line into the rear axle tee (D). Push the other end of the flexible line through the hole in the frame cross member (X) and slide the clip into the groove near the end of the flexible line. Screw the nut on the end of the master cylinder rear line assembly (KK) into the forward end of the flexible line. Bleed the lines (par. 246).

c. *Fittings.*

(1) *Front axle tee* (fig. 117).

(a) *Removal.* Unscrew the nuts connecting the two solid lines from the front axle tee (JJ). Unscrew the lockwasher bolt holding the tee to the axle. Unscrew the tee from the end of the flexible line, and remove the tee and copper gasket.

(b) *Installation.* Place a copper gasket on the end of the flexible line and screw the front axle tee (JJ) onto the end of the line. Position the tee on the hole in the axle and install the $\frac{1}{4}$ x $1\frac{1}{8}$ lockwasher bolt. Screw

the two nuts on the solid lines into the tee. Bleed the lines (par. 246).

(2) *Rear axle tee* (fig. 117).

(a) *Removal.* Unscrew the nuts on the two solid lines from the rear axle tee (D). Unscrew the lockwasher bolt holding the tee to the bracket on the rear axle. Unscrew the tee from the end of the flexible line and remove the tee and the copper gasket.

(b) *Installation.* Place the copper gasket on the end of the flexible line and screw the rear axle tee (D) onto the end of the line. Position the tee on the bracket on the rear axle and secure in place with the $\frac{1}{4}$ x $\frac{7}{8}$ lockwasher bolt. Screw the nuts on the two solid lines into the tee. Bleed the lines (par. 246).

(3) *Master cylinder outlet fitting* (fig. 114).

(a) *Removal.* Remove the master cylinder shield (par. 244a(1)). Unscrew the nut on the end of the master cylinder front line assembly (K) and the nut on the end of the master cylinder rear line assembly (H) from the outlet fitting (R). Disconnect the cable (L) from the stoplight hydraulic switch assembly (N) at the connector (M). Unscrew the outlet fitting bolt (P) with switch; remove the bolt, outlet fitting bolt gasket (Q), outlet fitting (R), and outlet fitting gasket (S) from the master cylinder assembly (T).

(b) *Installation.* Put a new outlet fitting bolt gasket (Q), the outlet fitting (R), and a new outlet fitting gasket (S) onto the outlet fitting bolt (P) in the order named. Screw the bolt into the master cylinder assembly (T) fingertight. Screw the nut on the end of the master cylinder front line assembly (K) into the outlet fitting. Screw the nut on the end of the master cylinder rear line assembly (H) into the outlet fitting. Tighten the outlet fitting bolt (P). Attach the connector (M) to the stoplight hydraulic switch assembly (N). Install the master cylinder shield (par. 244b(5)). Fill the master cylinder and bleed the brakes (par. 246).

246. Bleed Brakes

Note. The key letters noted in parentheses are in figure 114, except where otherwise indicated.

a. *Remove Inspection Cover.* Remove the four bolts and lockwashers from the brake master cylinder inspection cover (fig. 35). Remove the inspection cover and gasket. Reach through the inspection hole and clean the area around the filler cap assembly (W).

b. Fill Brake Master Cylinder. Unscrew the nut on the end of the master cylinder dash elbow-to-dash tee vent line (U) from the master cylinder-to-vent line elbow (V) on the top of the filler cap assembly (W). Remove the filler cap and gasket. Fill the master cylinder with hydraulic brake fluid.

c. Bleed Brakes. Clean the bleeder valve (fig. 115). Attach a bleeder hose to the bleeder valve and put the lower end of the hose into a transparent bottle or jar containing hydraulic brake fluid so that the end of the hose is submerged. Unscrew the bleeder valve approximately one-half turn. Depress the brake pedal by hand with a slow even pressure and allow it to return to its fully released position slowly. Repeat this operation until air bubbles cease to flow from the end of bleeder hose. Depress the brake pedal and hold in this position while the bleeder valve is screwed tightly into the wheel cylinder. Remove the hose. Release the brake pedal. Repeat the above procedure on each of the other three bleeder valves. Add brake fluid, if necessary, so that the level in the master cylinder is within one-half inch of the top of the cylinder. Install the filler cap assembly (W) and gasket. Screw the nut on the end of the master cylinder dash elbow-to-dash tee vent line (U) into the master cylinder-to-vent line elbow (V) on the filler cap assembly (W). Position the master cylinder inspection cover gasket and cover (fig. 35) on the floor pan. Place a $\frac{5}{16}$ -inch lockwasher over each of the four $\frac{5}{16} \times \frac{5}{8}$ bolts and screw them through the cover and into the floor pan.

247. Hand Brake

(fig. 118)

a. Adjustment. Be sure that hand brake handle is in the released position. Check to see that cable is free and released. Jack up on rear wheel. Turn the wheel until one pair of holes in the drum are in line with the shoe adjusting screws.

Note. The top screw has a left-hand thread, while the bottom screw has a right-hand thread.

Use the edges of the holes in the brake drum as a holding point for an adjusting tool, such as a screwdriver or small flat steel bar. Rotate the notched adjusting screws, as required, until the shoes are snug against the drum. Back off each of the adjusting screws seven notches to obtain correct running clearance between shoe and drum.

b. Removal.

Note. The hub of the companion flange, which must be removed, extends into the transfer through the transfer case oil seal. If the transfer case is not drained, oil will run out when the flange is removed.

(1) Drain the transfer.

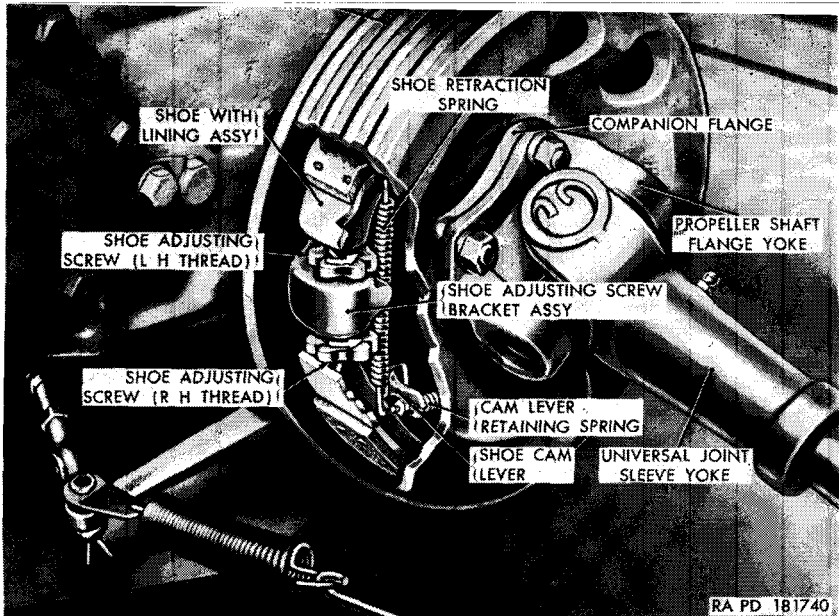

Figure 118. Hand brake—cutaway view.

- (2) Unscrew the four nuts holding the propeller shaft flange yoke to the companion flange and remove the lockwashers. Push the universal joint sleeve yoke back on the propeller shaft, and tie to some point of the vehicle frame out of the way.
- (3) Remove the cotter pin, hexagon nut, and flat washer from the rear end of the transfer output shaft. Pull the companion flange and hand brake drum off the output shaft. Remove the four bolts from the drum.
- (4) Unhook the two shoe retracting springs from the upper and lower shoes with lining assemblies. Remove the two shoes with lining assemblies.

c. Installation.

- (1) Position each shoe with lining assembly on the cam lever and a shoe adjusting screw. The shoes must be positioned to bring the ends on which the lining comes nearly to the end against the adjusting screws. Slide the end of the black shoe retracting spring into the hole in the lower shoe, near the right end, and hook the other end of the spring into the hole in the upper shoe. Hook the ends of the yellow shoe retracting spring into the holes in the up-

- per and lower shoes near the left or adjusting screw end.
- (2) Insert the four $\frac{3}{8}$ x $1\frac{3}{8}$ bolts through the brake drum from the front. Place the companion flange over the bolts at the rear of the drum. Slide the companion flange onto the transfer output shaft and the brake drum over the brake shoes.
 - (3) Place a $\frac{3}{4}$ -inch flat washer on the end of the transfer output shaft. Screw a $\frac{3}{4}$ -inch hexagon nut on the shaft and install the cotter pin.
 - (4) Slide the propeller shaft flange yoke onto the bolts and install the four $\frac{3}{8}$ -inch lockwashers and nuts.
 - (5) Adjust the hand brake (*a* above).
 - (6) Fill the transfer with lubricant (par. 66).

Section XXV. SPRINGS AND SHOCK ABSORBERS

248. Description and Data

a. Description. (figs. 119 and 120).

- (1) *Springs.* The semielliptic front and rear springs are mounted lengthwise in the vehicle. The front springs are secured at the front of the frame by a spring shackle and at the rear by a pivot bolt. The rear springs are secured at the front of the frame by a pivot bolt and at the rear by a spring shackle.
- (2) *Shock absorbers.* The shock absorbers are two-way control, direct acting hydraulic cylinder units. The rear shock absorbers are secured at the top end by a bracket welded to the frame and at the bottom end to the spring by a U-bolt plate. The front shock absorbers are secured at the top end by a bracket welded to the frame and at the bottom by a spring and shock absorber mounting seat. The shock absorbers are nonadjustable and nonrefillable.

b. Data.

Front springs:

Length (center-to-center of spring eyes)	36 $\frac{1}{4}$ in
Width	1 $\frac{3}{4}$ in
Number of leaves	10

Rear springs:

Length (center-to-center of spring eyes)	42 in
Width	1 $\frac{3}{4}$ in
Number of leaves	11

Shock absorbers:

Type	hydraulic
Action	two-way direct
Length compressed	10 $\frac{15}{16}$ in
Length extended	17 $\frac{1}{16}$ in

249. Organizational Maintenance

Springs and shock absorbers should be inspected periodically for signs of wear or breakage. Spring shackles should be lubricated in accordance with the lubrication order (par. 66). Springs, spring shackles, spring shackle bearings, spring pivot bolts, and shock absorbers should be replaced if damaged or worn.

250. Spring Shackles

(figs. 119 and 120)

Note. The removal and installation procedures for the front and rear springs are the same except for the threading of the spring shackle bearings. The lower end of the left front and right rear spring shackles have left-hand threads. All other spring shackle ends are threaded right hand. Bearings threaded left hand are identified by nick in the center of each corner of the hexagonal head. Shackles threaded left hand have a forged boss on the lower shank of the shackle.

a. Removal.

- (1) Place a jack under the axle housing and raise vehicle until both wheels clear the ground. Place safety stands or suitable blocking under bumper to support the weight of the vehicle. Adjust the height of the jack under the axle to relieve the tension on the spring.
- (2) Unscrew the two spring shackle bearings from the spring shackle.

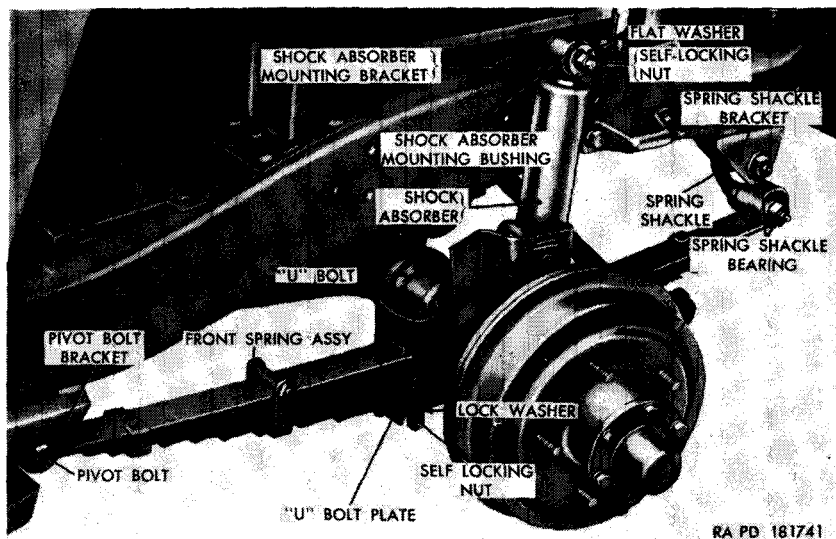

Figure 119. Front spring installed—right side shown.

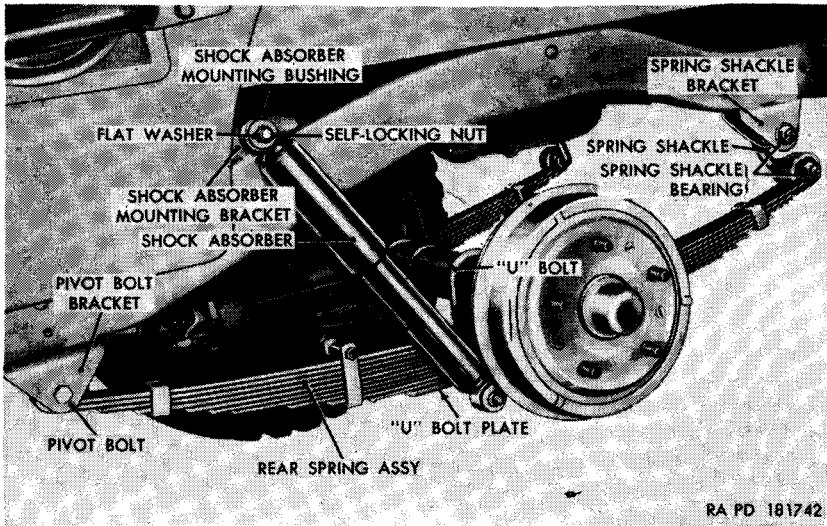

Figure 120. Rear spring installed—left side shown.

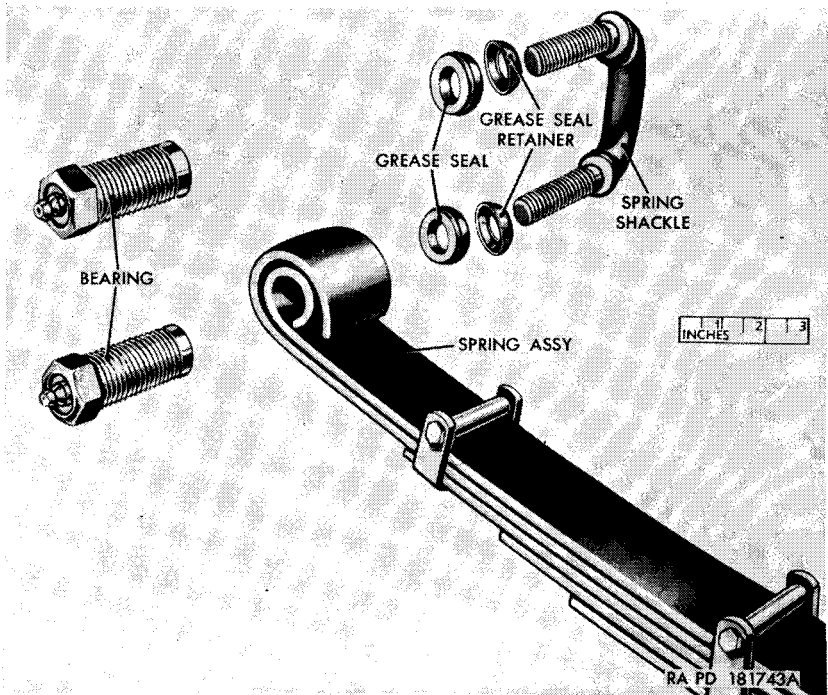

Figure 121. Spring shackle and spring.

- (3) Pull the spring shackle out of the spring eye and spring shackle bracket.
- (4) Pull the grease seals and grease seal retainers (fig. 121) off the shackle.

b. Installation.

- (1) Position the two grease seal retainers (fig. 121) on the two threaded ends of the shackle, with the cupped side of the retainers toward the ends of the shackle.
- (2) Position the two grease seals (fig. 121) on the two threaded ends of the shackle and seat them in grease seal retainers.
- (3) Insert one threaded end of the shackle through the mounting bracket and the other threaded end through the spring eye.
- (4) Hold the shackle tightly against the spring shackle bracket and screw the bearing part way onto the shackle.
- (5) Hold shackle tightly against spring eye and screw bearing part way onto the shackle.
- (6) Tighten the bearings alternately and evenly. Back off the lower bearing about one thirty-second inch.
- (7) Lubricate spring shackles (par. 66).
- (8) Remove the safety stands or blocking and lower vehicle to ground.
- (9) Road-test vehicle and check for tight spring shackles. If shackle is too tight, remove and again install spring shackle bearings.

251. Pivot Bolts

a. Removal.

- (1) Jack up vehicle high enough to take load off springs and support vehicle with safety stands or suitable blocking.
- (2) Unscrew the safety nut from the pivot bolt and withdraw bolt from spring eye bearing (fig. 122) and pivot bolt bracket (figs. 119 and 120).

b. Installation.

- (1) Position the spring assembly at the pivot bolt bracket (fig. 119 or 120). Aline the hole in spring eye bearing (fig. 122) with the hole in the pivot bolt bracket and insert the pivot bolt through the bracket and spring eye bearing from the outside. Secure the pivot bolt in position with a $\frac{3}{8}$ -inch safety nut (fig. 120).
- (2) Remove the safety stands or blocking and lower vehicle to ground.

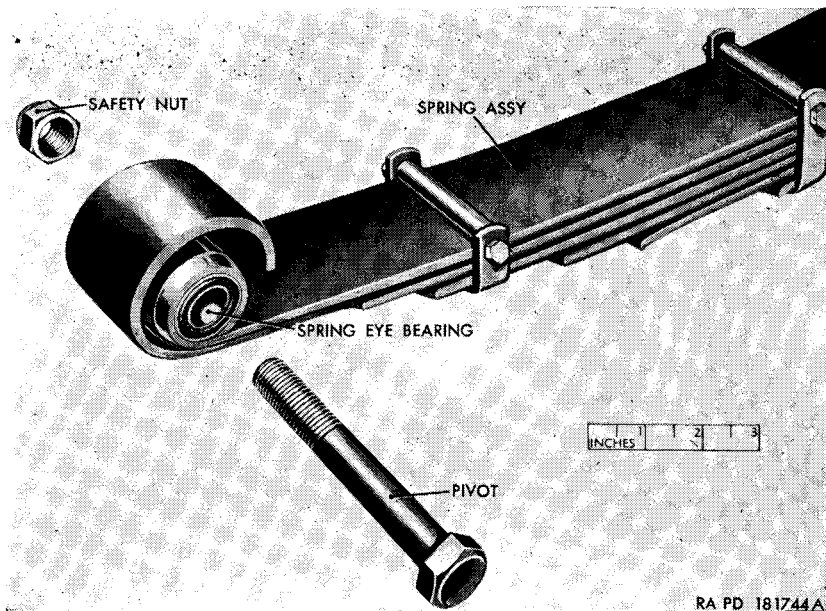

Figure 122. Pivot bolt and spring.

- (3) Rock vehicle from side to side to flex springs. Tighten nut on pivot bolt to torque of 27 to 30 pound-feet.

252. Springs

a. Removal.

- (1) Place a jack under the axle housing and raise vehicle until both wheels clear the ground. Place safety stands or suitable blocking under bumper to support weight of vehicle. Adjust the height of the jack under the axle housing to relieve the tension on the spring.
- (2) Remove spring shackle (par. 250).
- (3) Remove pivot bolt (par. 251).
- (4) Remove the self-locking nut and flat washer securing the shock absorber to the U-bolt plate (fig. 120), or spring and shock absorber mounting seat (fig. 119), and pull shock absorber free from plate or seat.
- (5) Remove the four U-bolt nuts securing the U-bolts and U-bolt plate, or the spring and shock absorber mounting seat. Remove the U-bolt, U-bolt plate, or spring and shock absorber mounting seat and spring.

Caution: Be careful that the spring does not drop when the nuts are removed and cause injury to personnel.

b. Installation.

- (1) Place spring in approximate position under vehicle, raise pivot bolt end of spring, and install pivot bolt (par. 251*b*(1)).
- (2) Raise spring shackle end of spring into position and install spring shackle (par. 250*b*(1) through (6)).
- (3) Slowly lower axle onto spring, making certain that spring center bolt enters the recess in spring saddle on the axle. Install the U-bolts over the axle and through the U-bolt plate (fig. 120), or spring and shock absorber mounting seat (fig. 119), and install the four $\frac{7}{16}$ -inch U-bolt nuts.
- (4) Position the lower or small end of the shock absorber on the stud of the U-bolt plate, or spring and shock absorber mounting seat, and secure in position with a $\frac{1}{2}$ -inch flat washer and $\frac{7}{16}$ -inch self-locking nut.
- (5) Remove the safety stands or blocking and lower vehicle to ground.
- (6) Rock vehicle back and forth to flex springs and tighten safety nut on pivot bolt to torque of 27 to 30 pound-feet.
- (7) Lubricate spring shackles (par. 66).
- (8) Road-test vehicle and check for tight spring shackles. If too tight, remove and again install spring shackle bearings (par. 250).

253. Shock Absorbers

(figs. 119 and 120)

a. Removal.

- (1) Remove the self-locking nut and flat washer securing the shock absorber to the shock absorber mounting bracket. Remove the self-locking nut and flat washer securing the shock absorber to the rear spring U-bolt plate, or the front spring and shock absorber mounting seat.
- (2) Pull the shock absorbers and shock absorber mounting bushings off the bracket and the rear spring U-bolt plate or front spring mounting seat.
- (3) Pull the shock absorber mounting bushing out of the shock absorber.

b. Installation.

- (1) Install a shock absorber mounting bushing, with the taper facing out, on the shaft of the shock absorber mounting bracket and on the shaft of the rear spring U-bolt plate or the front spring and shock absorber mounting seat.

- (2) Position the shock absorber, small end down, on the bushings and install two more shock absorber mounting bushings with the tapers facing in.
- (3) Secure the shock absorber in position with two 1/2-inch flat washers and 7/16-inch self-locking nuts. Tighten each nut until a slight bulge is noted in the mounting bushings.

Section XXVI. WHEELS AND TIRES

254. Description and Data

a. Description. Each vehicle is equipped with five standard drop-center, interchangeable wheels; four operating and one spare. Each operating wheel is mounted on the wheel hub by five studs pressed into the hub and attached by five hub nuts. A taper on the inside of each hub nut positions the wheel to allow clearance between wheel and hub for ease of removal. Hub studs and nuts on the left side of the vehicle have left-hand threads and are marked with the letter L. Hub studs and nuts on the right side of the vehicle have right-hand threads and are not marked. The military, nondirectional mud and snow-type tires are designed for either high or low pressure operation.

b. Data.

Wheels:

Ordnance number	7387807
Type	standard drop-center
Rim size	4.50 x 16.00
Stud circle diameter	5.496 x 5.504

Tires:

Type	military nondirectional
Size	7.00 x 16.00

Operating pressures:

Highway	25 psi
Cross country	25 psi
Mud, sand, or snow	10 psi

255. Organizational Maintenance

a. Wheels. Inspect all wheels at regular intervals for bent rims, worn or elongated mounting stud holes, and signs of rust. Pay particular attention to edges of rims and mounting stud holes. Inspect hub studs and nuts for worn or stripped threads. Replace any defective hub or hub nut immediately.

b. Tires. Inspect all tires and check pressures daily.

- (1) Replace any tire with noticeable cut on tread or side wall. Return old tire to ordnance maintenance unit for repair. If uneven wear is indicated, check toe-in adjustment (par. 234). If incorrect toe-in is not the cause, report to ordnance maintenance personnel.
- (2) Check pressures when tires are cold. Dismount any tire showing unusual pressure loss and examine tire tube for cause. Repair tire tube or replace tube or tire if necessary.
- (3) Inflate all tires to equal pressures, as unequal pressures will affect steering and braking adversely. Inflate tires to pressures designated in paragraph 254b. Underinflated tires are easily damaged. Install all valve caps to prevent air loss.

c. Tire Rotation. To maintain equal wear, rotate tires in accordance with the tire rotation plan, shown in figure 123, at intervals of approximately 2,000 miles, if the tactical situation permits.

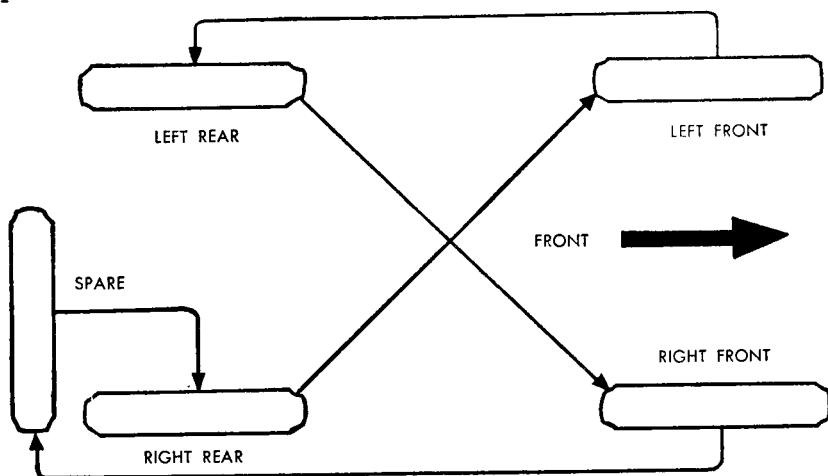

Figure 123. Tire rotation plan.

RA PD 181745

d. Tire Replacement. Make certain that a replacement tire is of the same design, size, and tread as the tires on the vehicle. Tires of different design or tread sometimes have different rolling diameters, causing excessive scuffing in use.

256. Wheels

a. Removal. Loosen five hub nuts (left side vehicle, clockwise—right side, counterclockwise). Jack up vehicle until tire clears the ground (fig. 124). Block other wheels to prevent vehicle from rolling (fig. 125). Remove five hub nuts and remove wheel.

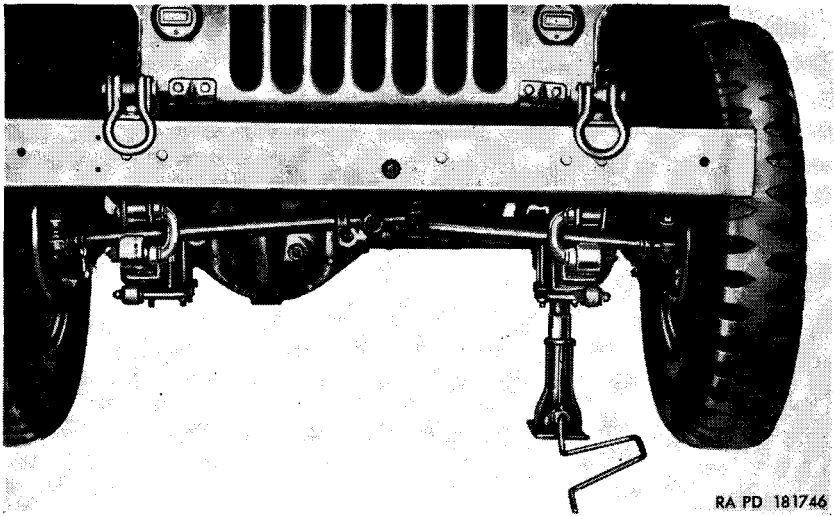

Figure 124. Correct position of jack for wheel removal.

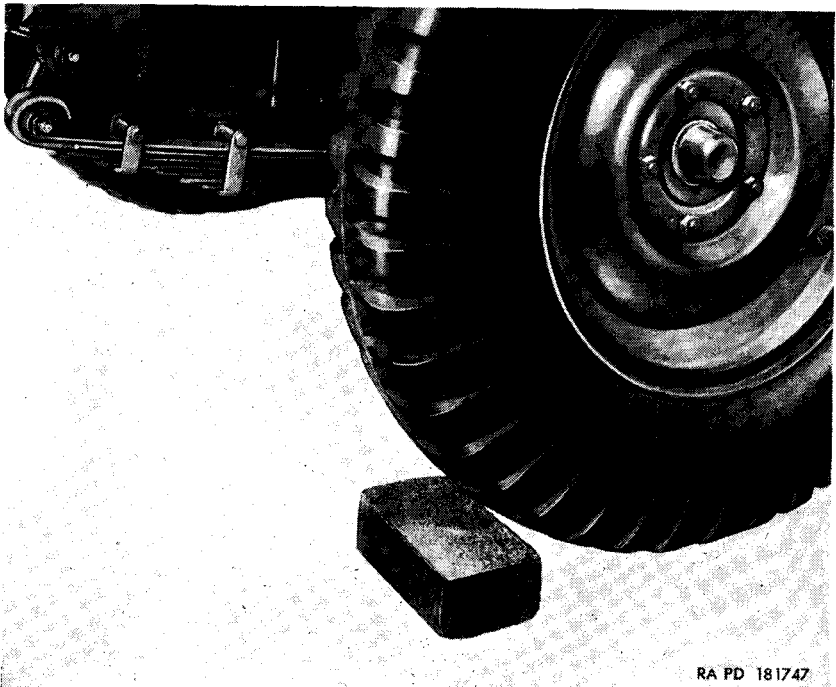

Figure 125. Wheel blocked to prevent vehicle moving during wheel removal.

b. Installation. Clean adjacent surfaces of wheel and hub. Make certain that hub studs and nuts are free of grease or oil. Place wheel on studs and start five 1/2-inch nuts on stud threads (left side of vehicle, counterclockwise—right side of vehicle, clockwise). Tighten nuts alternately and evenly. Lower vehicle to the ground and remove blocking. Tighten hub nuts again.

257. Tires and Tubes

For instructions on removal, repair, and installation of tires and tubes, refer to TM 21-300.

Section XXVII. BODY AND FRAME

258. Description and Data

a. Description. The body of the 1/4-ton 4 x 4 utility truck M38 (figs. 1, 2, and 3) is an all-steel, four-passenger, open, utility model. The box-type steel frame has five cross members for additional strength. Removable driver's and passenger's seats have detachable seat cushions. These seats are located in the front section of the passenger compartment. The passenger's seat is hinged to provide access to the tool compartment under the seat. A rear seat, located in the rear of the passenger compartment, may be folded for additional cargo space. The rear seat also has detachable cushions. Weather protection is provided by a canvas top cover, curtains, and doors which may be removed and stored in clement weather. A one-piece, folding-type windshield, with two vacuum operated windshield wiper motors attached to the windshield frame, is secured to the body cowl. The windshield wipers also can be operated manually. An outside rear view mirror is mounted on the body cowl to the left of the driver. The removable hood and front fenders are formed sheet metal. The radiator and front of the vehicle are protected by a bumper bar and radiator guard attached to the front of the frame. Two bumperettes, attached to the rear of the body at each side, protect the rear of the vehicle. Five reflex reflectors are attached to the rear section of the body, one on either side and three on the back. A towing pintle, attached to the rear frame cross member, provides the means for towing a trailer. Lifting shackles are attached to the frame side rails.

b. Data.

Body type	all steel, open
Driver's position	left side
Frame type	all steel, box
Frame length	122 $\frac{3}{16}$ in
Frame width	29 $\frac{1}{4}$ in
Number of frame cross members	5
Windshield type	one-piece, folding
Windshield wiper motors (two)	vacuum operated

259. Organizational Maintenance

All body and frame bolts should be tightened periodically. Body and frame should be kept clean and all rust spots sanded and painted. Any damaged or inoperative units should be replaced.

260. Windshield

a. Lowering and Raising. To lower windshield, unclamp the two windshield lock assemblies (N, fig. 7). Carefully lower windshield toward front of vehicle until it rests on the two windshield bumpers on the front of the hood. Secure the windshield in the lowered position by inserting one end of the windshield hold-down strap through the bracket, welded to the windshield frame, and securing the strap in its buckle. To raise windshield, unbuckle windshield hold-down strap and withdraw strap from the bracket. Raise windshield to upright position and secure the windshield lock assemblies (N, fig. 7) to the two locking clamps on the windshield frame.

b. Removal. Pull the windshield wiper hose off the windshield wiper line (fig. 126) at each side of the vehicle. Unclamp the two windshield lock assemblies (N, fig. 7) and place windshield in lowered position. Unscrew the windshield pivot bolt (fig. 126) and remove the windshield pivot bolt flat washer and windshield pivot bolt spring washer from the windshield pivot bracket on each side of the vehicle. Lift the windshield off the vehicle.

c. Installation. Place the windshield, in the lowered position, over the hood and cowl. Aline the mounting holes in the windshield frame with the mounting holes in the windshield pivot bracket (fig. 126). Install a windshield pivot bolt flat washer on the windshield pivot bolt and push the pivot bolt through the mounting hole in the windshield frame. Install a windshield pivot bolt spring washer on the pivot bolt between the windshield frame and windshield pivot bracket. Screw the pivot bolt into the bracket and tighten. Repeat procedure on other side of vehicle. Raise the windshield and secure windshield lock assemblies (N, fig. 7) to

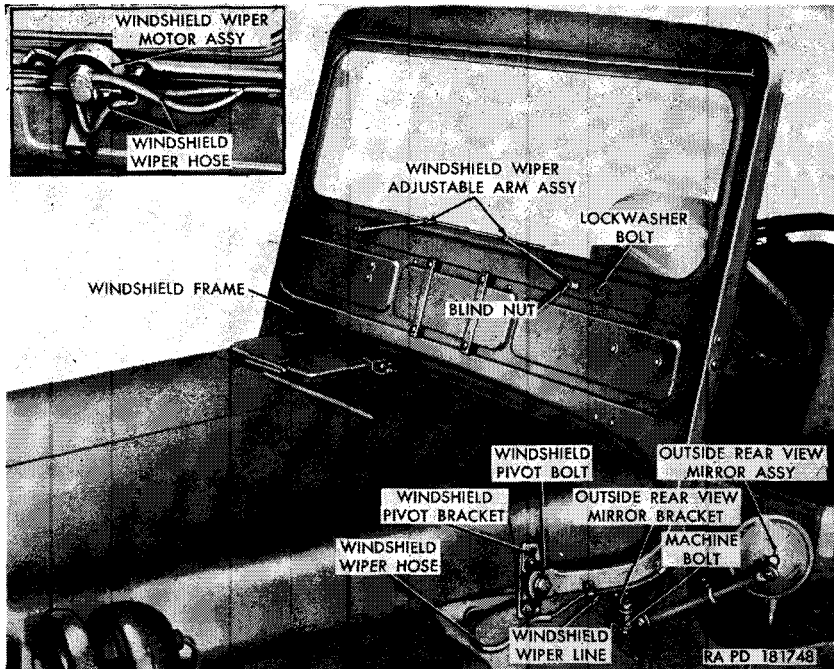

Figure 126. Windshield, windshield wiper motor assemblies, and outside rear view mirror assembly.

the two locking clamps on the windshield frame. Slide the windshield wiper hose onto the windshield wiper line (fig. 126) at each side of the vehicle.

261. Hood

(fig. 127)

a. Raising and Lowering. To raise hood, unhook hood catches from catch bracket on each side of vehicle. Lift hood and let it rest against windshield frame. To lower hood, pull forward at top of hood and lower gently. Secure hood in position by hooking the hood catches in the catch brackets on each side of the vehicle.

b. Removal. Unhook the hood catch from the catch bracket on each side of the vehicle. Raise hood and let it rest against windshield frame. Unscrew the five lockwasher screws securing the hood and hood hinge to the cowl and remove screws and flat washers. Lift hood off vehicle.

c. Installation.

Note. If the corners of the slave receptacle and air intake base aperture, located at the bottom edge of right side of hood, grip sharp corners of hood firmly with pliers and bend inward until sharp points are turned over. Sand exposed metal and points.

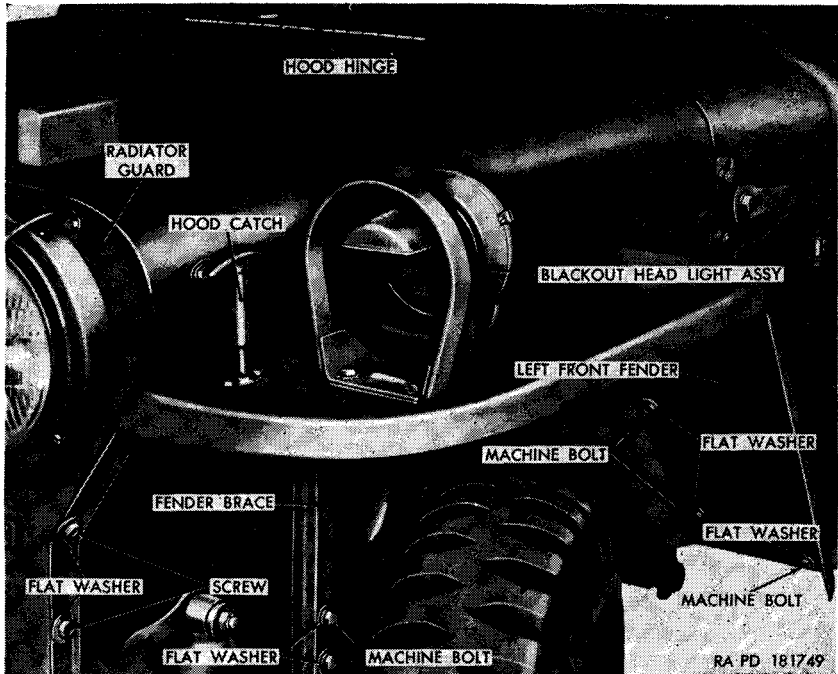

Figure 127. Hood and left front fender.

Position the hood over vehicle cowl in upright position. Align the mounting holes in the hood hinge with the mounting holes in the cowl and secure hood in position with five $\frac{9}{32}$ -inch flat washers and $\frac{1}{4} \times \frac{5}{8}$ lockwasher screws. Lower hood and secure in position by hooking the two hood catches onto the catch brackets.

262. Fenders

Note. If both front fenders are to be removed, start by removing radiator guard (par. 263). If only one fender is to be removed, proceed as in *a*(1) and (2) below.

a. Removal.

- (1) *Left front fender* (fig. 127). Raise the hood and rest it against the windshield frame. Remove blackout headlight (par. 158). Remove horn (par. 185). Unhook the cables from the five clips on the fender and splasher. Remove the bolts, lockwashers, and nuts from the clips holding the hand brake cable and fuel line to the fender splasher. Remove the four bolts, lockwashers, and flat washers securing the rear of the left front fender to the body. Remove the two bolts, lockwashers, and flat washers

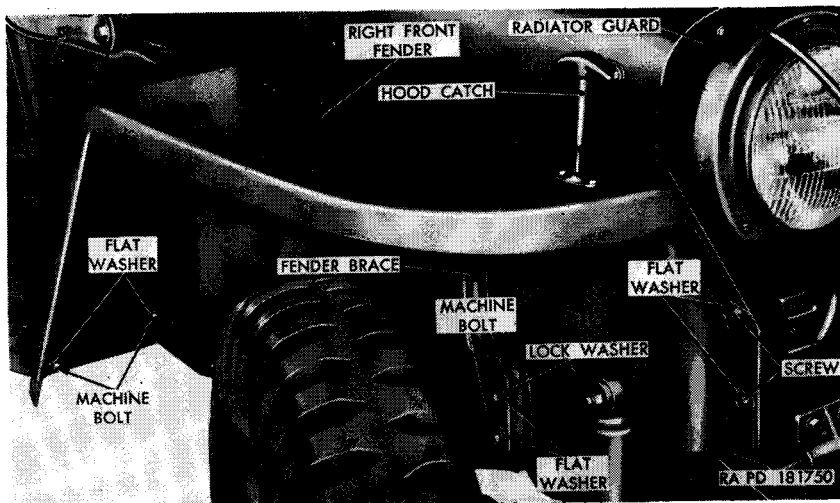

Figure 128. Right front fender.

securing the fender brace to the frame. Remove the three screws and flat washers securing the fender to the radiator guard. Pull the fender to the left and remove.

- (2) *Right front fender.* Raise hood and rest it against windshield frame. Remove the bolt and plain nut securing the clip for the battery-to-battery cable (fig. 68) to the fender and pull clip and cable away from fender. Remove the wing nuts and lockwashers securing the battery box-to-fender straps (fig. 68) to the fender. Remove the three screws, and flat washers securing the fender to the radiator guard (fig. 128). Remove the two bolts, lockwashers, and flat washers securing the fender brace (fig. 128) to the frame. Remove the three bolts, lockwashers, and flat washers (fig. 128) securing the rear of the fender to the body and pull fender to the right and remove.

b. Installation.

- (1) *Left front fender* (fig. 127). Position the fender on the body, aligning the mounting holes with the mounting holes in the body, frame, and radiator guard. Secure the fender brace to the frame with two $\frac{3}{8}$ -inch lockwashers, $\frac{7}{16}$ -inch flat washers, and $\frac{3}{8} \times \frac{3}{4}$ bolts. Secure the rear of the fender to the body with four $\frac{5}{16}$ -inch lockwashers, $\frac{7}{16}$ -inch flat washers, and $\frac{5}{16} \times \frac{5}{8}$ bolts. Secure the front of the fender to the radiator guard with three $\frac{5}{16}$ -inch flat washers and $\frac{5}{16} \times \frac{7}{8}$ screws. Install horn (par.

185). Install blackout headlight (par. 158). Secure the clips, holding the hand brake cable and fuel line to the fender splasher, with No. 10 x $\frac{1}{2}$ bolts, lockwashers, and nuts. Push the cables into the five clips secured to the fender and splasher.

- (2) *Right front fender.* Position the fender on the body, aligning the mounting holes with the mounting holes in the body, frame, and radiator guard. Secure the fender brace to the frame with two $\frac{3}{8}$ -inch lockwashers, $\frac{7}{16}$ -inch flat washers, and $\frac{3}{8}$ x $\frac{3}{4}$ bolts (fig. 128). Secure the rear of the fender to the body with three $\frac{5}{16}$ -inch lockwashers, $\frac{7}{16}$ -inch flat washers, and $\frac{5}{16}$ x $\frac{5}{8}$ bolts (fig. 128). Secure the front of the fender to the radiator guard with three $\frac{5}{16}$ -inch flat washers and $\frac{5}{16}$ x $\frac{7}{8}$ screws (fig. 128). Position the battery box-to-fender straps over the bolts in the fender. Install two $\frac{5}{16}$ -inch lockwashers and $\frac{5}{16}$ -inch wing nuts on the bolts. Position the battery-to-battery cable and clip against the fender and secure in position with a No. 10 x $\frac{5}{8}$ bolt and No. 10 plain nut.

263. Radiator Guard

a. Removal. Open the hood and disconnect the headlight and blackout marker light cables (fig. 129) at the left side of the vehicle. Loosen the six screws and flat washers securing the radiator guard to the right and left front fenders (figs. 128 and 127). Tilt the guard forward until slots in hinges are aligned with hinge pins and lift guard (fig. 129) off vehicle.

b. Installation. Place the radiator guard in position at the front of the vehicle. Aline the slot in hinges with hinge pins (fig. 129) and lower guard onto hinge pins. Raise the guard into position, entering the six screws into the slots in the fenders with the washers between the screw heads and the fenders. Tighten the six screws securing the guard to the fenders (figs. 127 and 128). Connect the headlight and blackout marker light cables (fig. 129) at the left side of the vehicle.

264. Canvas Top, Doors and Side Curtains

(fig. 130)

a. Removal.

- (1) Lift up on the door curtain assembly to disengage the door curtain rod from the door lower hinge socket. Swing bottom of door curtain out and pull down to disengage door curtain rod from door upper hinge socket. Pull

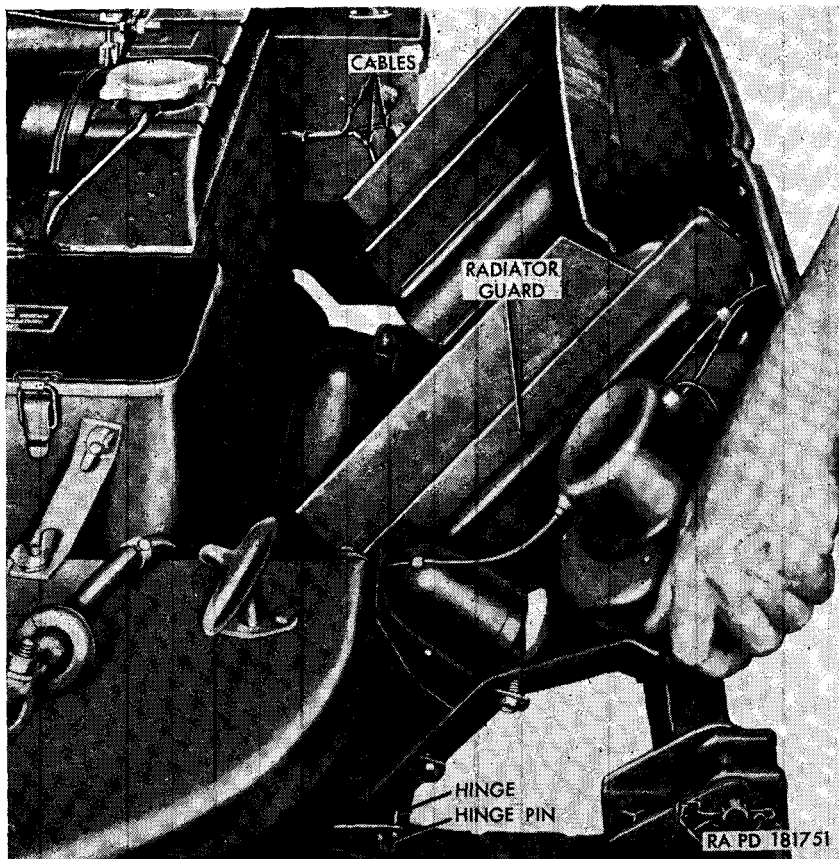

Figure 129. Removing radiator guard.

- down on the door curtain to remove the door curtain bead out of the door curtain upper and lower retainers. Repeat procedure on other side of vehicle.
- (2) Unbuckle the three hold-down straps securing the bottom of the side curtain to the hold-down brackets on the side of the vehicle and pull straps out of brackets. Turn the seven double fasteners securing the side curtain to the top cover and rear curtain assembly and pull curtain from vehicle. Lift up on the side curtain rod to disengage rod from side curtain rod lower socket and swing side curtain and rod out from vehicle. Pull down on the rod and curtain to disengage the rod from side curtain rod top bracket. Repeat procedure on other side of vehicle.
 - (3) Unbuckle the six hold-down straps securing the top cover and rear curtain assembly to the hold-down brackets

mounted on the rear of the vehicle and pull straps out of bracket. Working inside the vehicle, release the three flaps securing the top cover to the front top bow. Lift the top cover and rear curtain assembly up and over the top bow assembly and toward the front of the vehicle. Grasp one edge of the top cover at the top retainer and slide the bead of the cover out of the retainer.

- (4) Withdraw the pin of the chain assembly from the hole in the top rail. Pull one hooked end of the top rail out of the top rail bracket welded to the windshield frame. Pull the opposite end out of the hole in the front top bow. Repeat the procedure at other side of vehicle.
- (5) Fold the front top bow back against the rear top bow. Unscrew the thumb screw on the thumb screw chain assembly at each side of vehicle. Lift the top bow assembly end out of the rear top bow sockets. Place the assembly in a horizontal position on the body, aligning the mounting holes in the rear top bow with the mounting holes in the rear top bow stowage bracket at each side of the vehicle. Secure the top bow assembly to the stowage brackets with the thumb screws of the thumb screw chain assemblies. Secure the top bow assembly to the body by looping the two top bow hold-down straps around the top bow assembly and into the brackets on the body. Buckle the hold-down straps. Carefully fold and store the top cover and rear curtain assembly, side curtains, and door curtains. Extreme care must be taken to prevent damage to the windows. Fold all metal parts inside canvas, making certain that metal rods do not touch the vinylite windows. Fold canvas smoothly to avoid cracks and tears.

b. Installation.

- (1) Release the top hold-down straps securing the top bow assembly in the stored position. Unscrew the thumb screw at each rear top bow stowage bracket. Lift the top bow assembly off the rear top bow stowage brackets and insert flat ends into the rear top bow sockets. Aline the mounting holes on the flat ends with the mounting holes in the bow sockets. Working from inside the vehicle, insert the thumb screw of the thumb screw chain assembly through the hole in the body and the bow and screw into bow socket.
- (2) Position a top rail with the side curtain rod top bracket toward the front top bow and insert the hooked end of

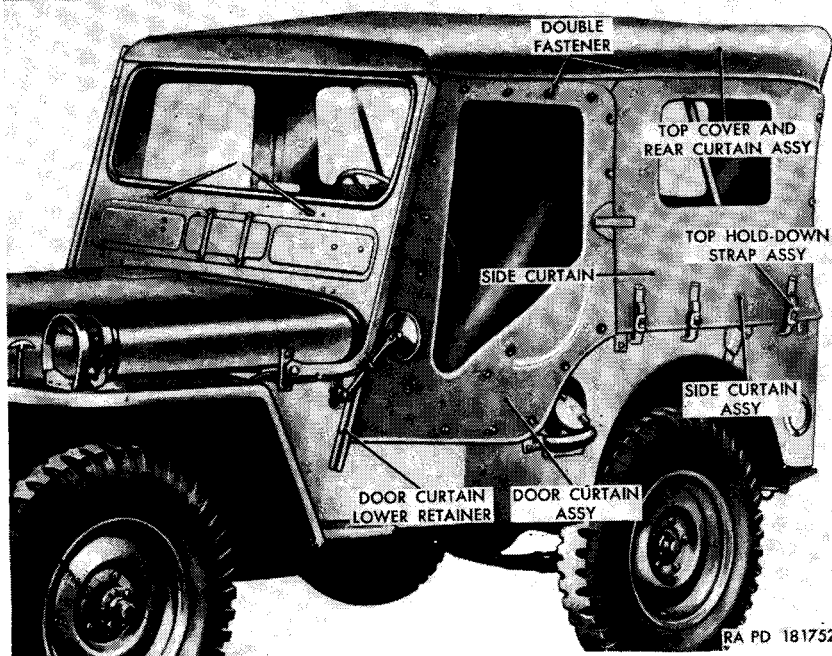
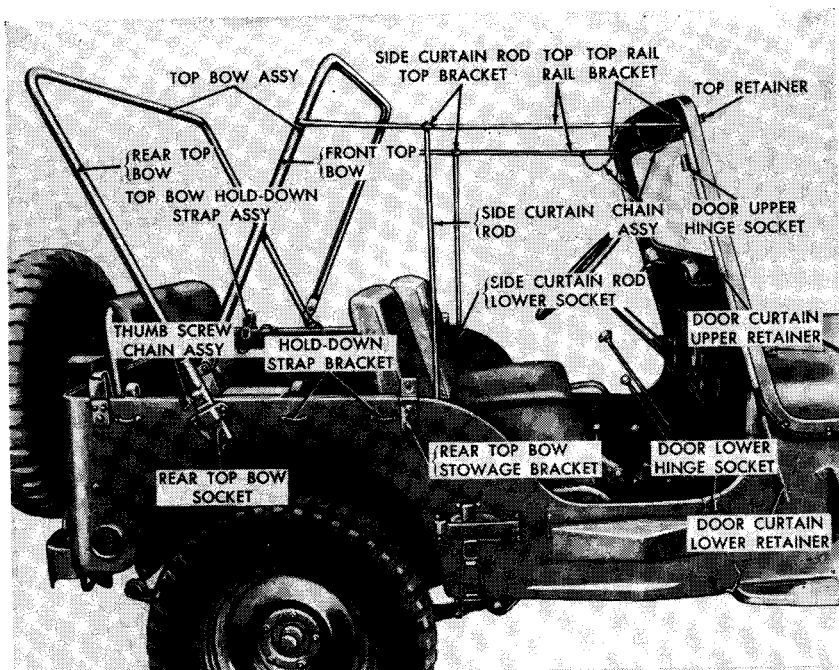

Figure 130. Top cover and rear curtain assembly, side curtains, door curtains, and top bow assembly.

the rail into the hole in the bow. Insert the other hooked end of top rail into top rail bracket on the windshield frame. Secure the top rail in position at the top rail bracket by inserting the pin of the chain assembly through hole in the hooked end of the top rail. Repeat the procedure at other side of vehicle.

- (3) Insert the front bead of the top cover and rear curtain assembly into one edge of the top retainer. Slide top bead into retainer until bead is centered in place. Position the top cover and rear curtain over the top bow assembly and secure to rear of vehicle by inserting the six top hold-down straps through the six top hold-down strap brackets and buckling straps. Secure the top cover and rear curtain to the front top bow by fastening the three flaps on the top cover around the front top bow.
- (4) Insert a side curtain rod through the bead of a side curtain. Position the top of the rod in the side curtain rod top bracket on the top rail. Lift up on the side curtain and rod and swing into position over side curtain rod lower socket. Seat the rod in the socket. Position the upper edge of the side curtain between the double flaps of the top cover and secure with the four double fasteners. Secure the rear of the side curtain to the top cover with three double fasteners. Secure the bottom of the side curtain to the body by inserting the three hold-down strap assemblies through the hold-down brackets and buckling straps. Repeat procedure on other side of vehicle.
- (5) Insert the upper end of the bead on the door curtain assembly into the lower end of the door curtain lower retainer. Work the bead up through the lower retainer and into upper retainer. Insert the upper end of the door curtain rod into the door upper hinge socket. Swing lower section of door curtain over the door lower hinge socket and seat door curtain rod in the socket. Repeat procedure on other side of vehicle.
- (6) Check, tighten, and secure all hold-down straps and double fasteners.

265. Windshield Wiper Motors

(fig. 126)

Note. Procedures in this paragraph apply to either windshield wiper motor assembly.

a. Removal. Unscrew the blind nut securing the windshield wiper adjustable arm assembly to the shaft of the windshield

wiper motor paddle and remove the arm. Pull the windshield wiper hose off the lines of the windshield wiper motor assembly. Unscrew the two lockwasher bolts securing the windshield wiper motor assembly to the windshield frame and remove the motor from the frame.

b. Installation. Working inside the vehicle, insert the shaft of the windshield wiper motor paddle through the hole in the windshield frame. Push the windshield wiper hose onto the lines of the windshield wiper motor assembly. Working outside the vehicle, secure the windshield wiper motor to the windshield frame with two No. 10 x $\frac{7}{8}$ lockwasher bolts. Position the windshield wiper adjustable arm assembly on the projecting shaft with the windshield wiper blade parallel to the windshield frame as shown in figure 126. Secure the wiper arm to the motor shaft with a No. 10 blind nut. Start the engine and test windshield wipers for proper operation.

266. Windshield Wiper Blade

a. Removal. Pull the upper end of the adjustable arm assembly away from the windshield and unhook the windshield wiper blade from the end of the arm assembly.

b. Installation. Pull the upper end of the adjustable arm assembly away from the windshield. Hold the windshield wiper blade in front of the arm assembly, wiping edge forward and hook pointing down; insert the hook into the hole in the upper end of the arm; then swing the lower end of the blade forward and up to completely engage the hook. Release the adjustable arm assembly.

267. Lifting Shackles and Towing Pintle

a. Front Lifting Shackles with Brackets (fig. 131).

(1) *Removal.* Pull the retaining clip out of the retaining pin. Withdraw the pin from the shackle bracket and remove the shackle. Remove the two plain nuts, bolts, lockwashers, flat washers, and the one spacer holding the shackle bracket to the bumper bar and frame side rail and remove the bracket.

(2) *Installation.* Position the shackle bracket on the bumper bar and the frame side rail. Secure the bracket to bumper bar with $\frac{1}{2}$ x $1\frac{1}{4}$ bolt, $1\frac{1}{32}$ -inch flat washer, $\frac{1}{2}$ -inch lockwasher, and $\frac{1}{2}$ -inch plain nut. The flat washer goes between the bracket and the bolt head. Position a shackle bracket spacer between the bracket and frame side rail. Install a $1\frac{1}{32}$ -inch flat washer on a $\frac{1}{2}$ x 2 bolt and insert the bolt through the bracket, spacer, and side rail.

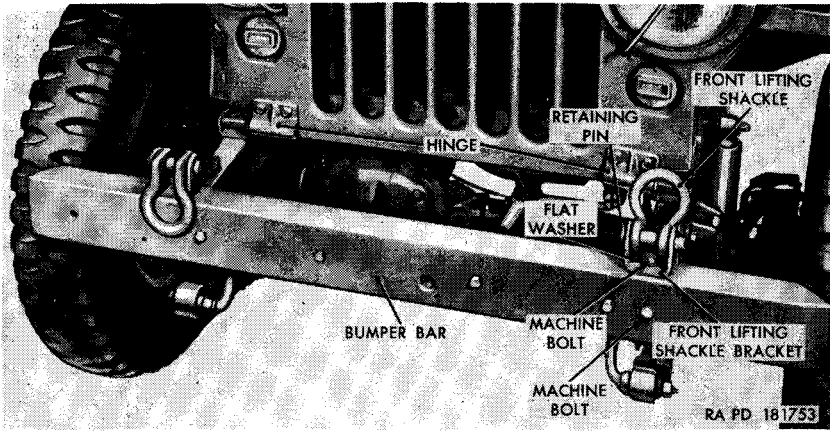

Figure 131. Bumper bar and front lifting shackles.

Secure with a 1/2-inch lockwasher and 1/2-inch plain nut. Place the shackle in the bracket, insert the retaining pin through the bracket and shackle, and install the retaining clip through the pin.

b. Rear Lifting Shackles with Brackets (fig. 132).

- (1) *Removal.* Pull the retaining clip out of the retaining pin. Withdraw the pin from the shackle bracket and remove

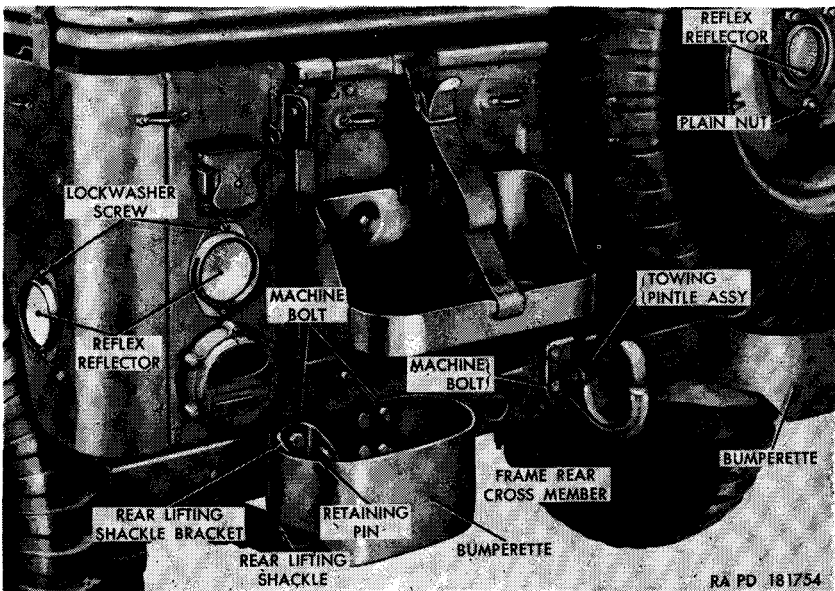

Figure 132. Bumperettes, rear lifting shackles, towing pintle assembly, and reflex reflectors.

the shackle. Remove two plain nuts, lockwashers, flat washers, and bolts holding the shackle bracket to the bumperette and frame rear cross member and remove the shackle bracket.

- (2) *Installation.* Position the shackle bracket inside the bumperette. Push two $\frac{1}{2} \times 1\frac{1}{4}$ bolts through the shackle bracket, bumperette, and frame rear cross member and install two $\frac{17}{32}$ -inch flat washers, $\frac{1}{2}$ -inch lockwashers, and $\frac{1}{2}$ -inch plain nuts. Place the shackle in the bracket, insert the retaining pin through the bracket and shackle, and install the retaining clip through the end of the pin.

c. *Towing Pintle* (fig. 132).

- (1) *Removal.* Remove the four nuts, lockwashers, and bolts securing the towing pintle to the frame rear cross member and remove the pintle.
- (2) *Installation.* Position the towing pintle on the frame rear cross member and secure in position with four $\frac{1}{2} \times 1\frac{7}{8}$ bolts, $\frac{1}{2}$ -inch lockwashers, and $\frac{1}{2}$ -inch nuts.

268. Seats and Cushions

a. *Driver's Seat* (fig. 133).

- (1) *Removal.* Remove the four lockwasher screws securing the seat frame to the front and rear floor pans and wheel panel and lift seat out of vehicle.

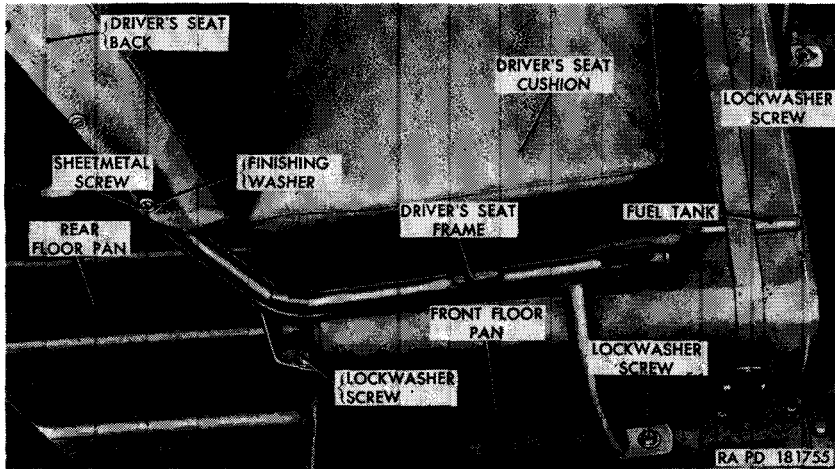

Figure 133. Driver's seat

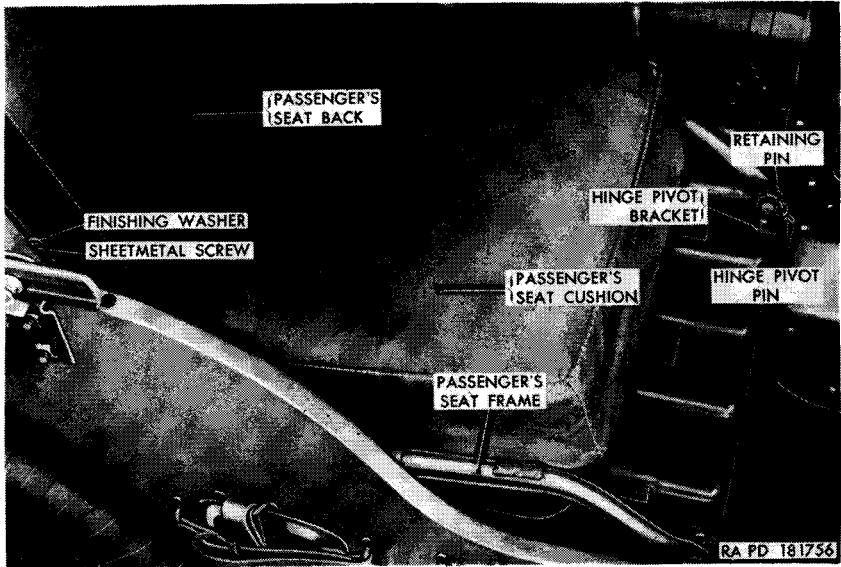

Figure 134. Passenger's seat.

- (2) *Installation.* Position the driver's seat over the fuel tank, aligning the mounting holes in the seat frame with the mounting holes in the floor pans and wheel panel. Secure the seat in position with two $\frac{5}{16} \times \frac{5}{8}$ lockwasher screws at the front floor pan, and two $\frac{5}{16} \times \frac{7}{8}$ lockwasher screws at the rear floor pan and wheel panel.

b. Passenger's Seat (fig. 134).

- (1) *Removal.* Remove the two retaining pins from the hinge pivot pins welded to the seat frame. Pry the pivot pins out of the hinge pivot brackets and remove seat from vehicle.
- (2) *Installation.* Position the two hinge pivot pins, welded to the seat frame, in the hinge pivot brackets. Secure the pivot pin by inserting retaining pins through the ends of the pivot pins.

c. Rear Seat (fig. 135).

- (1) *Removal.* Remove the four plain nuts, lockwashers, and bolts holding the retaining clips in position at each side of vehicle and remove clips from seat retaining brackets. Lift the seat straight up and out of vehicle.
- (2) *Installation.* Position the seat in vehicle so that seat upper frame is inside the two seat upper frame retainers and the seat lower frame is in the rear seat retaining brackets. Position the retaining clips in the retaining

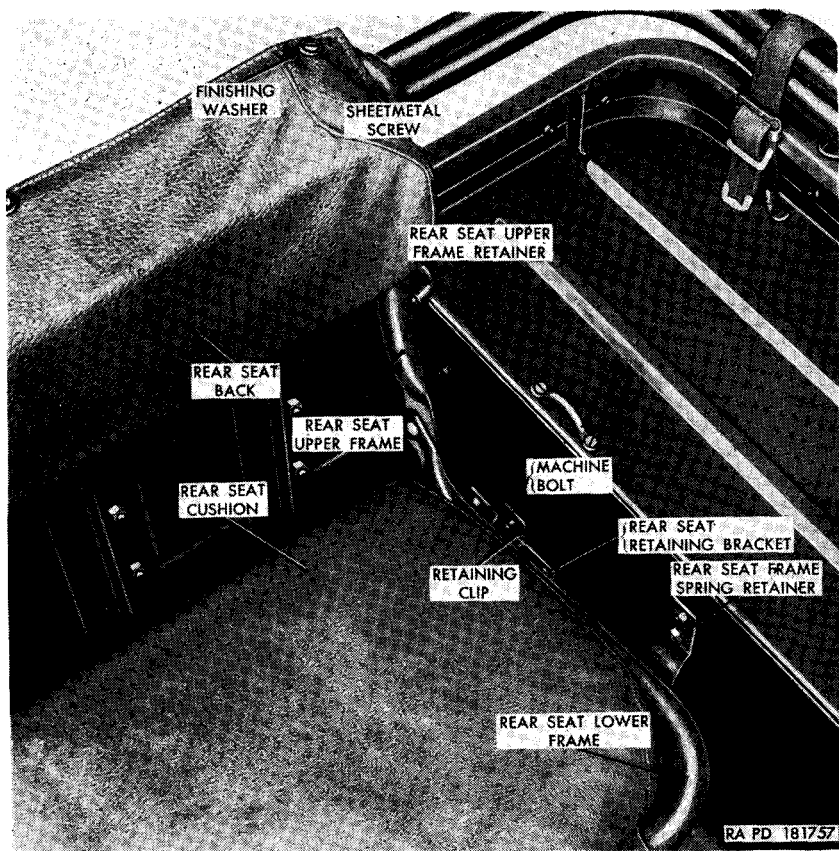

Figure 135. Rear seat disconnect points.

brackets and secure with four $\frac{1}{4}$ x $\frac{3}{4}$ bolts, $\frac{1}{4}$ -inch lockwashers, and $\frac{1}{4}$ -inch plain nuts at each side of vehicle.

d. *Driver's Seat Cushion* (fig. 133).

(2) *Removal.* Remove driver's seat (a(1) above). Remove the two lockwasher screws securing the seat cushion to the seat frame. Pull out on seat cushion to disengage clips at rear of cushion from seat frame and remove cushion. Remove the 12 sheet metal screws and finishing washers securing the seat back to the seat frame and lift seat back off frame.

(2) *Installation.* Position the seat cushion in the seat frame and push cushion back in frame to engage the clips on the cushion with the frame. Secure the seat cushion to the seat frame with two $\frac{5}{16}$ x $\frac{5}{8}$ lockwasher screws. Install the seat in the vehicle (a(2) above). Position the seat back on the seat frame and secure in position with 12

No. 10 by $\frac{1}{2}$ sheet metal screws and No. 10 finishing washers.

e. Passenger's Seat Cushion (fig. 134).

- (1) *Removal.* Tilt the seat forward and remove the two lockwasher screws securing the seat cushion to the seat frame. Pull out on seat cushion to disengage clips at rear of cushion from seat frame and remove cushion from frame. Remove the 12 sheet metal screws and finishing washers securing the seat back to the seat frame and lift the back off the frame.
- (2) *Installation.* Position the seat cushion in the seat frame and push cushion back into frame to engage the clip on the cushion with the frame. Secure the cushion to the frame with two $\frac{5}{16}$ x $\frac{5}{8}$ lockwasher screws. Position the seat back on the seat frame and secure in position with 12 No. 10 x $\frac{1}{2}$ sheet metal screws and No. 10 finishing washers.

f. Rear Seat Cushion (fig. 135).

- (1) *Removal.* Remove the 10 sheet metal screws and finishing washers securing the seat cushion to the seat lower frame and lift the seat cushion out of the seat frame. Remove the 10 sheet metal screws securing the seat back to the seat upper frame and lift seat back off frame.
- (2) *Installation.* Position the seat cushion on the seat lower frame and secure in position with 10 No. 10 x $\frac{1}{2}$ sheet metal screws and No. 10 finishing washers. Position the seat back on the seat upper frame and secure in position with 10 No. 10 x $\frac{1}{2}$ sheet metal screws and No. 10 finishing washers.

269. Bumper Bar and Bumperettes

a. Bumper Bar (fig. 136).

- (1) *Removal.* Remove the front lifting shackles and shackle brackets (par. 267a(1)). Remove the six plain nuts, lockwashers, and bolts securing the bumper bar to the frame side rails and remove the bumper bar.
- (2) *Installation.* Position the bumper bar at the front of the vehicle, aligning the mounting holes in the bar with the mounting holes in the frame side rails. Secure the bar to the side rails with six $\frac{3}{8}$ x $\frac{3}{4}$ bolts, $\frac{3}{8}$ -inch lockwashers, and $\frac{3}{8}$ -inch plain nuts. Install the front lifting shackles and shackle brackets (par. 267a(2)).

b. *Bumperettes* (fig. 132).

- (1) *Removal*. Remove rear lifting shackle (par. 267b(1)). Remove the two plain nuts, lockwashers, and bolts securing the bumperette to the frame rear cross member and remove the bumperette.
- (2) *Installation*. Position the bumperette on the frame rear cross member and secure in position with two $\frac{1}{2}$ x $\frac{7}{8}$ bolts, $\frac{1}{2}$ -inch lockwashers, and $\frac{1}{2}$ -inch plain nuts. Install the rear lifting shackle (par. 267b(2)).

270. Reflex Reflectors (fig. 132)

a. *Removal*.

Note. Removal and installation procedures are the same for each of the four reflex reflectors mounted on the body.

Remove the two plain nuts and lockwasher screws and remove reflector. Remove the reflector mounted on the spare wheel support by removing the three plain nuts securing the spare wheel to the spare wheel support and remove wheel. Remove the two plain nuts and screws securing the reflector to the spare wheel support and remove reflector.

b. *Installation*. Position reflex reflector on body and secure with two $\frac{1}{4}$ x $\frac{5}{8}$ lockwasher screws and $\frac{1}{4}$ -inch plain nuts. Position reflector on spare wheel support and secure with two $\frac{1}{4}$ x $\frac{5}{8}$ screws and $\frac{1}{4}$ -inch plain nuts. Place spare wheel on the three spare wheel studs and install three $\frac{1}{2}$ -inch plain nuts.

271. Outside Rear View Mirror (fig. 126)

a. *Removal*. Remove the four nuts and bolts securing the mirror bracket to the body and remove mirror and bracket.

b. *Installation*. Position the mirror assembly and bracket on the body, aligning the mounting holes in the bracket with the mounting holes in the body. Secure the bracket to the body with four No. 12 x $\frac{1}{2}$ bolts and No. 12 nuts.

Section XXVIII. MAINTENANCE UNDER UNUSUAL CONDITIONS

272. Extreme-Cold Weather Maintenance Problems

a. The importance of maintenance must be impressed on all concerned, with special emphasis on organizational (preventive) maintenance. Maintenance of mechanical equipment in extreme cold is exceptionally difficult in the field. Even shop maintenance

cannot be completed with normal speed, because the equipment must be allowed to thaw out and warm up before the mechanic can make satisfactory repairs. In the field, maintenance must be undertaken under the most difficult of conditions. Bare hands stick to cold metal. Fuel in contact with the hands results in supercooling due to evaporation, and the hands can be painfully frozen in the matter of minutes. Engine oils, except subzero grade, are unpourable at temperatures below -40° F. Ordinary greases become as solid as cold butter.

b. These difficulties increase the time required to perform maintenance. At temperatures below -40° F., maintenance requires up to five times the normal amount of time. The time required to warm up a vehicle so that it is operable at temperatures as low as -50° F. may approach 2 hours. Vehicles in poor mechanical condition probably will not start at all, or only after many hours of laborious maintenance and heating. Complete winterization, diligent maintenance, and well trained crews are the key to efficient arctic-winter operations.

c. Refer to TM 9-2855 for general information on extreme-cold weather maintenance procedures.

d. Refer to TB 9-2855-3 for information on winterization kit for this vehicle.

273. Extreme-Cold Weather Maintenance

Refer to TM 9-2855 for general discussion of maintenance problems, the application of antifreeze compounds and arctic-type lubrication, handling of storage batteries in extreme-cold, and de-winterization procedure. Also refer to paragraph 58.

274. Extreme-Hot Weather Maintenance

a. *Cooling System.* Thoroughly clean and flush cooling system (par. 113) at frequent intervals and keep system filled to within three-quarters of an inch of the overflow pipe with clean water when operating in extremely high temperatures. Formation of scale and rust in the cooling system occurs more rapidly during operation in extremely high temperatures, therefore, corrosion-inhibitor compound should always be added to the cooling liquid. Avoid the use of water that contains alkali or other substances which may cause scale and rust formations. Use soft water whenever possible.

b. *Batteries.*

- (1) *Electrolyte level.* In torrid zones, check level of electrolyte in cells daily and replenish, if necessary, with pure distilled water. If this is not available, rain or drinking

water may be used. However, continuous use of water with high mineral content will eventually cause damage to batteries and should be avoided.

- (2) *Specific gravity.* Batteries operating in torrid climates should have a weaker electrolyte than for temperate climates. Instead of 1.280 specific gravity as issued, the electrolyte (sulphuric acid sp gr 1.280) should be diluted to 1.200 to 1.240 specific gravity (TM 8-2857). This is the correct reading for fully-charged batteries. This procedure will prolong the life of the negative plates and separators. Batteries should be recharged at about 1.160 specific gravity.
- (3) *Self-discharge.* A battery will self-discharge at a greater rate if left standing for long periods at high temperatures. This must be considered when operating in torrid zones. If necessary to park for several days, remove the battery and store in a cool place.

Note. Do not store acid-type storage batteries near stacks of tires, as the acid fumes have a harmful effect on rubber.

c. Chassis and Body.

- (1) In hot, dry climates, a careful watch must be kept for evidence of the presence of moths and termites.
- (2) In hot, damp climates, corrosive action will occur on all parts of the vehicle and will be accelerated during the rainy season. Evidence will appear in the form of rust and paint blisters on metal surfaces and mildew, mold, or fungus growth on wood, fabrics, leather, and glass.
- (3) Protect all exposed exterior painted surfaces from corrosion by touchup painting and keep a film of engine lubricating oil (OE-10) on unfinished exposed metal surfaces. Cables and terminals should be protected by ignition-insulation compound.
- (4) Make frequent inspections of idle, inactive vehicles. Remove corrosion from exterior metal surfaces with abrasive paper or cloth and apply a protective coating of paint, oil, or suitable rust preventive.

275. Maintenance After Fording

a. General. Although the vehicle unit housings are sealed to prevent the free flow of water into the housings, it must be realized that, due to the necessary design of these assemblies, some water may enter, especially during submersion. The following services should be accomplished on all vehicles which have been exposed to some depth of water or completely submerged,

especially in salt water. Precautions should be taken as soon as practicable (par. 70) to halt deterioration and avoid damage before the vehicle is driven extensively in regular service.

b. Body and Chassis. Drain and clean out body, engine, and tool compartment; clean all exposed painted surfaces and touchup paint where necessary. Coat unpainted metal parts with engine lubricating oil (OE-10). Lubricate the chassis thoroughly as directed in the lubrication order (par. 66). Do more than the usual lubrication job, making sure the lubricant is forced into each lubrication point to force out any water present.

c. Engine, Transmission, Transfer Case, and Axles. Check the lubricant in the engine, transmission, transfer case, and axles. Should there be evidence that water has entered, drain, flush, and refill with the correct lubricant. Remove and clean engine oil filter.

d. Wheels and Brakes. Remove the front wheels and flush out the knuckle housings with a half-and-half mixture of engine lubricating oil (OE-10) and dry-cleaning solvent or volatile mineral spirits. Refill to filler plug level with the correct lubricant. Remove rear wheels. Wash all wheel bearings thoroughly with dry-cleaning solvent or volatile mineral spirits, after which, repack, assemble, and adjust. While the wheels are removed, dry out brake linings and clean rust and scum from brake drum face. Check brake system for presence of water.

e. Batteries. Check the batteries for quantity and specific gravity of electrolyte to be sure no water has entered through the vent caps. This is of special importance should the vehicle have been submerged in salt water.

f. Steering Gear. Remove and disassemble steering gear. If the lubricant is contaminated, clean the housing thoroughly with a half-and-half mixture of engine lubricating oil (OE-10) and dry-cleaning solvent or volatile mineral spirits. Assemble, refill with correct grade of lubricant, and adjust (par. 239).

g. Electrical Connections. Check all electrical connections for corrosion, particularly the bayonet-type connectors.

h. Fuel System. Drain fuel tank of any accumulated water, clean fuel filter and lines as necessary. If water is found in the air cleaner, clean and refill with oil (par. 66).

i. Distributor. Remove the distributor cap and check to determine if any water has entered the distributor. If water is present, drain, clean, and lubricate the distributor as required.

j. Condensation. Although most units are sealed, the sudden cooling of the warm interior air upon submersion may cause con-

densation of moisture within the cases or instruments. A period of exposure to warm air after fording should eliminate this fault. Cases which can be opened may be uncovered and dried.

k. Aluminum or Magnesium Parts. If vehicle remains in salt water for any appreciable length of time, aluminum or magnesium parts which were exposed to the water will probably be unfit for further use and must be replaced.

l. Deep-water Fording. Refer to TM 8-2853 for deep-water fording information.

276. Maintenance After Operation on Unusual Terrain

a. Mud. Thorough cleaning and lubrication of all parts affected must be accomplished as soon as possible after operation in mud, particularly when a sea of liquid mud has been traversed. Clean radiator fins and interior of engine compartment. Repack wheel bearings if necessary (par. 66). Clean, oil, and stow tire chains in vehicle.

b. Sand or Dust. Clean engine and engine compartment. Touch up all painted surfaces damaged by sandblasting. Lubricate completely to force out lubricants contaminated by sand or dust. Air cleaners, and fuel and oil filters must be cleaned at least daily. Radiator fins should be cleaned daily with compressed air when operating in dusty terrain. Engine and other exposed vents should be covered with cloth at all times. When halted, engine grilles should be covered to protect the engine against entrance of sand or dust.

CHAPTER 4

SHIPMENT OF MATERIEL AND DESTRUCTION TO PREVENT ENEMY USE

Section I. SHIPMENT OF MATERIEL

277. Shipping Instructions

a. Preparation. When shipping the 1/4-ton 4x4 utility trucks M38, the officer in charge of preparing the shipment *will be responsible* for furnishing the vehicles to carriers for transport in a *serviceable* condition, adequately protected against corrosion, deterioration, and damage during shipment from the supply source to the first receiving activity for immediate use (Level C Packaging and Packing of AR 740-15), as prescribed in SB 9-4 (type I processing) and in paragraphs 279 and 280 (loading and blocking).

Note. Type I processing of SB 9-4 is considered as meeting the requirements of Level C of AR 740-15.

b. Responsibility for Removal of Preservatives Before Shipment. Personnel withdrawing vehicles from storage for shipment *must not remove preservatives* other than to insure that the vehicles are complete and serviceable. If it has been determined that preservatives have been removed, they must be restored to the prescribed level prior to shipment. Removal of preservatives is the responsibility of depots, ports, and field installations (posts, camps, and stations) receiving shipments.

c. Marking of Arctic-Lubricated Materiel. It will be the responsibility of the officer in charge of the organization performing arctic lubrication to insure that the equipment is marked as prescribed in SR 746-30-10. It will be the responsibility of the officer in charge of the organization shipping arctic-lubricated equipment to insure that each item is so marked. Commanders of using organizations will insure that such markings are not obliterated while the equipment is arctic-lubricated. When the equipment is deprocessed of the special lubrication, such marking will be immediately and thoroughly obliterated.

d. Army Shipping Documents. Prepare all Army shipping documents accompanying the vehicles in accordance with TM 38-705.

e. Deep-water Forging. If deep-water fording is anticipated during shipment, prepare vehicles in accordance with TM 9-2853.

278. Receiving Instruments

a. If vehicles are received in a damaged condition or improperly processed, notify the transportation officer and prepare a DD Form 6 in accordance with SR 745-45-5.

b. Prior to use, deprocess the vehicles as prescribed in SB 9-4 and service the vehicles as prescribed in paragraphs

279. Loading the ¼-TON 4x4 Utility Truck M38 on Railroad Flatcars

a. Preparation.

- (1) When vehicles are shipped by rail, every precaution must be taken to see that they are properly loaded and securely fastened and blocked to floor of flatcar.
- (2) On-vehicle materiel (OVM) will be thoroughly cleaned, preserved, packed (boxed or crated), and securely stowed in or on the vehicle as prescribed in SB 9-4. Publications will be packed in heavy duty, type 1 heat sealable, grade A, waterproof, class b bags (Method 1C-3) and packed in the OVM container. Publications provided by separate technical services will be packed in the same OVM container as the material to which they are applicable.
- (3) Load vehicle on flatcars so they will not form an unbalanced load.
- (4) After a vehicle has been finally spotted on flatcar, apply parking brakes.
- (5) Increase tire pressure slightly higher than normal, except when vehicles are exposed to extremely hot-weather conditions.

b. *Method of loading the ¼-ton 4x4 utility truck M38 on flatcars.* For method of loading and general loading rules pertaining to rail shipment of ordnance vehicles, see TM 9-1005 and TB 9-OSSC-G.

Warning: The height and width of vehicles, when prepared for rail transportation, must not exceed the limitations indicated by the loading table in AR 700-105 (sec II). Whenever possible, local transportation officers must be consulted about the limitations of the particular railroad lines to be used for the movement in order to avoid delays, dangerous conditions, or damage to equipment.

280. Blocking the ¼-TON 4x4 Utility Truck M38 for Rail Shipment

a. *General.* All blocking instructions specified herein are minimum and are in accordance with "Pamphlet No MD-7, Rules Governing the Loading of Defense Materiel on Open Top Cars" of the

Association of American Railroads. Additional blocking may be added, as required, at the discretion of the officer in charge. Double-headed nails may be used, except in the lower piece of two piece cleats. All reference letters in *b* through *e* below refer to details and locations in figures 136 and 137. The number of vehicles to be loaded will depend upon the length of flatcar.

Note. Any other loading instructions, regardless of source, which are in conflict with this publication or existing loading rules of the carriers, must be submitted for approval to the Chief of Ordnance, Washington 25, D. C.

b. Brake Wheel Clearance "A." Load vehicles on flatcars, with a minimum clearance of at least 4 inches below and 6 inches above, behind, and to each side of the brake wheel. Increase clearance provided it is consistent with proper location of load.

Note. Three methods of blocking are given herein; the method to be used will depend on dimensions of flatcars and availability of required blocking materials. The instructions herein are for vehicles, double-loaded, as shown in figure 136. Vehicles may be single-loaded, double-deck loaded, or incline-loaded (with the front wheels of the second vehicle positioned in the rear body of the first vehicle and the front wheels of the third vehicle positioned in the rear body of the second vehicle, etc).

c. Method 1.

- (1) *Chock blocks "B"* (6 x 9 x 12, six rqr per truck, constructed as shown in detail 1, fig. 2). Locate the 53° surface of blocks against the front and rear of each outside wheel, against the front of each inside front wheel, and against the rear of each inside rear wheel. Nail heel of each block to car floor with three forty-penny nails and toenail both sides of blocks to car floor with one forty-penny nail each.

Note. Alternate type B-1 or B-2 chock blocks may be constructed as shown in details 2 and 3, figure 131, and located against tires as shown in details 1 and 2, figure 136. Single-loaded vehicles require chock blocks at the front and rear of all four wheels.

- (2) *Inside wheel blocks "C"* (6 x 9 x 12, four rqr per truck constructed as shown in detail 1, fig. 137). Locate the 6 x 9 surface of block flush against the inside of each wheel, as shown in figure 136. Nail heel of each block to car floor with four forty-penny nails and toenail each side to floor with one forty-penny nail.

Note. Alternate type inside wheel blocks C-1, may be constructed as shown in detail 4, figure 137, and located against tires as shown in detail 2, figure 136. When inside wheel blocks C-1 are used, cushioning material "D" (wtrprf paper or burlap) will be placed between blocks C-1 and inside of tire. The material should extend 2 inches beyond block on car floor and 2 inches above block against side of tire.

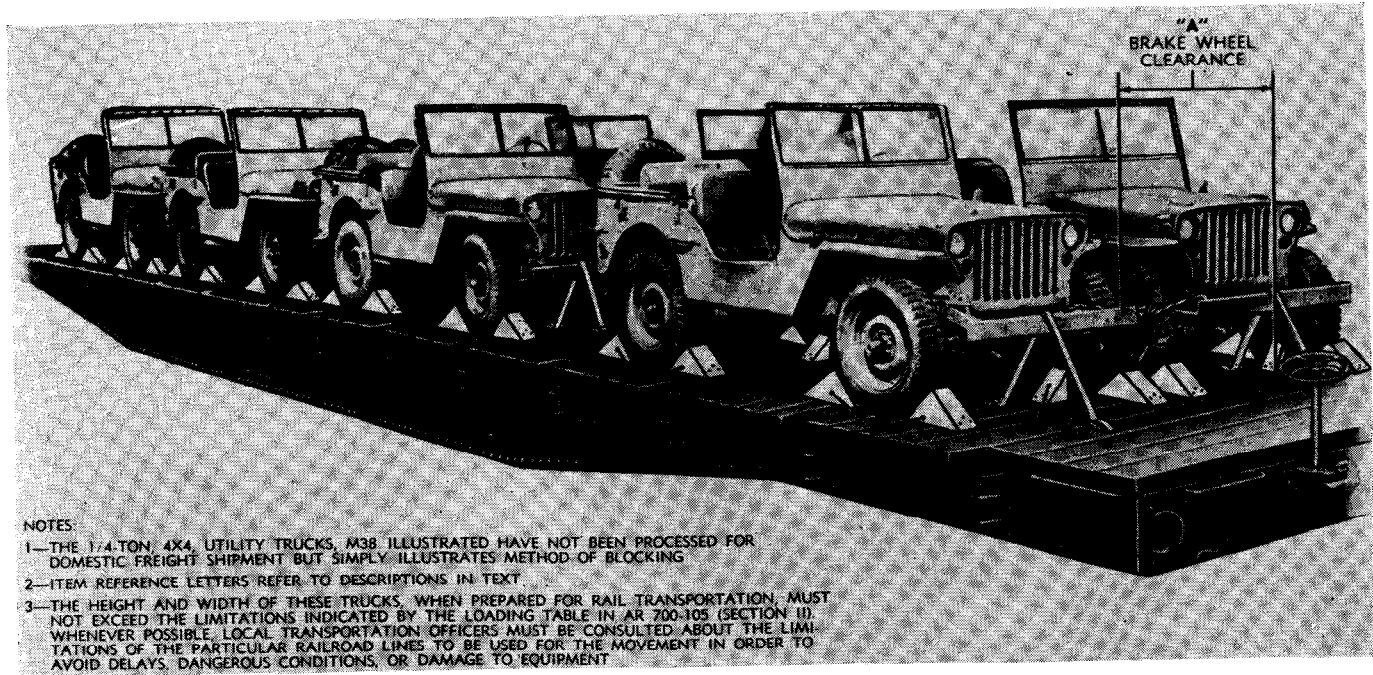

Figure 136. Methods of blocking the 1/4-ton 4x4 utility trucks M38 on flatcars.

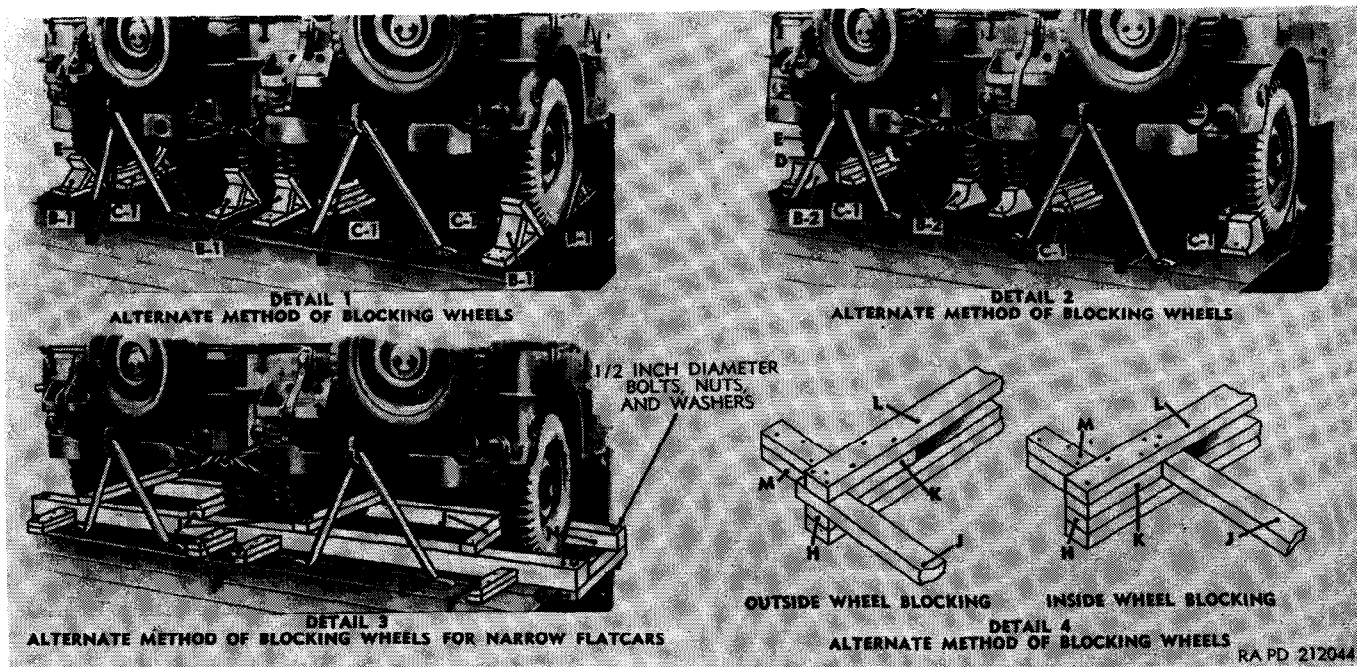

Figure 137. Methods of blocking the 1/4-ton 4x4 utility trucks M38 on flatcars (details).

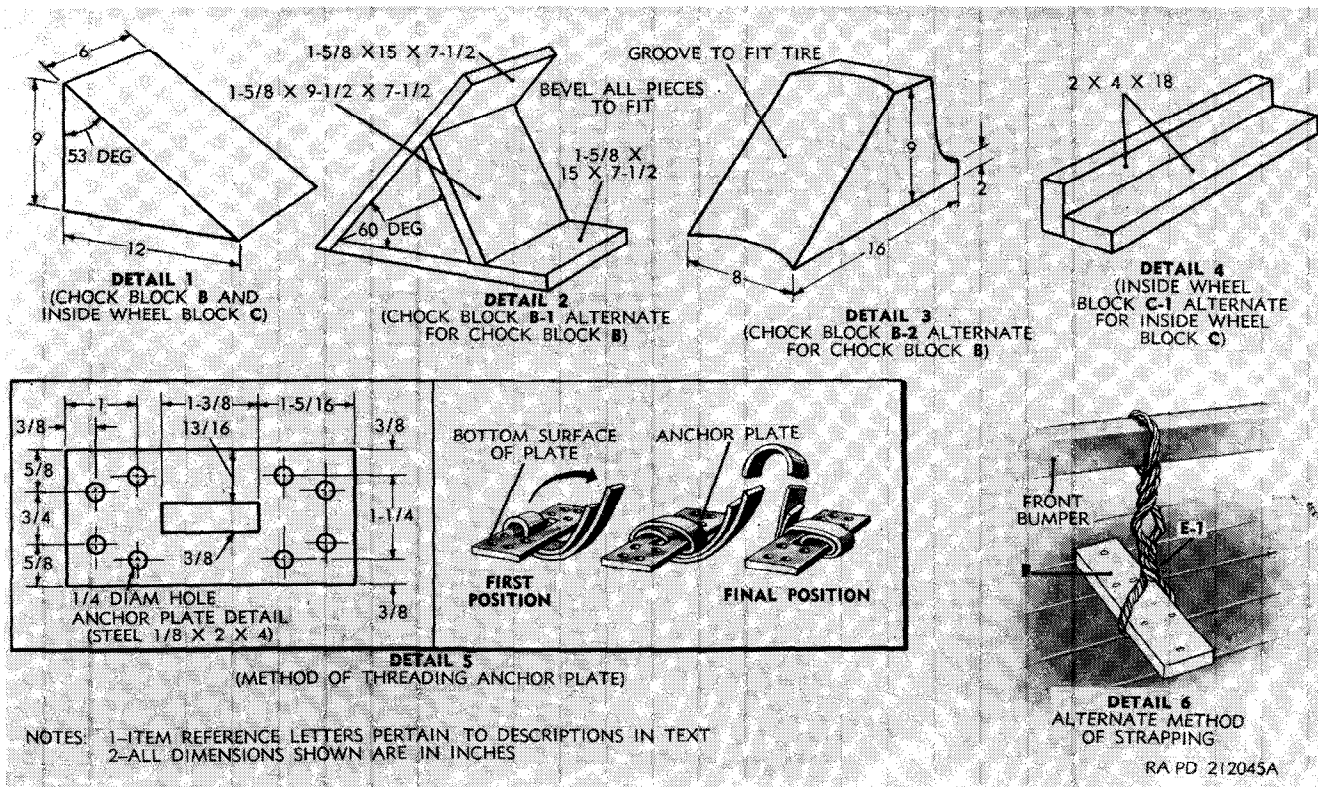

Figure 137. Methods of blocking the 1/4-ton 4x4 utility trucks M38 on flatcars (details)—Continued.

- (3) *Vehicle strapping "E" (1 in. No. 14 BW ga, hot-rolled steel, lgh to suit, two rqr per truck).* Locate strapping "E" over front bumper of vehicle and through rear pulling hook of vehicle, as shown in figure 136. Pass strapping through two anchor plates (detail 5, fig. 137) and nail anchor plates to car floor with eight twentypenny nails. Substitute, if desired, four strands of No. 8 gage, black annealed wire, E-1, twist-tie to form cables. Pass the cable over the bumper or through the pulling hook underneath and around random 2 x 4 cleat "F" (detail 6, fig. 137). Nail cleat lengthwise to car floor and twist-tighten cables to remove all slack.
- (4) *Vehicle ties "G" (6 strands, 3 wrappings, No. 8 ga, black anld wire, lgh to suit).* Pass cables around frame (bumpers, hooks, brackets, etc.) at front and rear of every two side-by-side vehicles as shown in figure 136. Twist-tighten cables to remove all slack.

d. *Method II.*

- (1) *Wheel cleats "N" (4 in. wd, 6 in. high, 8 in. longer than width of car, four rqr per truck).* Locate a cleat "N" across the front and rear of front and rear wheels as shown in detail 3, figure 136, and toenail each to car floor with four thirtypenny nails.
- (2) *Wheel supports "Q" (2 x 4, 2 in. longer than distance between outside faces of cleats "N", four rqr per truck).* Locate the two-inch side of support "Q" against each side of car floor. Secure each end to cleats "N" with 1/2-inch diameter bolt, nut, and washer, as shown in detail 3, figure 136.
- (3) *Wheel cleats "J" (2 x 4, 2 in. longer than distance between outside faces of cleats "N", four rqr per truck).* Locate cleat "J" across top cleats "N" with sides of cleats "J" flush against inside of tires, as shown in detail 3, figure 136. Nail end of each cleat "J" to cleats "N" with three twentypenny nails.
- (4) *Support cleats "P" (2 x 4 x 18, eight rqr per truck).* Locate four cleats "P" equidistant across car floor, with ends flush against cleats "N", as shown in detail 3, figure 136. Nail cleat to car floor with four thirtypenny nails. Locate one cleat on top of each lower cleat and nail with four thirtypenny nails.

e. *Method III.*

- (1) *Wheel cleats "H" (2 x 4, lgh to suit, eight rqr for every two side-by-side vehicles).* Locate a cleat "H" across flatcar, close to front and rear of front and rear wheels,

and nail to car floor with ten thirtypenny nails; locate a cleat on each lower cleat and nail with ten thirtypenny nails as shown in detail 4, figure 136.

- (2) *Wheel side cleats "J"* (2 x 4, lgh 4 in. longer than distance between outer face of cleats "H," four rqr per vehicle). Locate a cleat "J" against inside or outside of wheels as shown in detail 4, figure 136, and nail each end to cleats "H" with three twentypenny nails.
- (3) *Intermediate cleats "K"* (2 x 4, eight rqr per vehicle). Locate a cleat "K" on top of cleats "H," with end flush against cleat "J," and nail to cleats "H" with two twentypenny nails as shown in detail 4, figure 136.

Note. If flatcar is too narrow, cleats "J" will be placed on the inside of wheels and cleats "K" will be placed on the outside of cleats "J". If flatcars are wide enough, cleats "J" will be placed on the outside of wheels and cleats "K" will be on the inside of cleats "J".

- (4) *Upper cleat "L"* (2 x 4, lgh to equal cleats "H", four rqr per truck). Locate a cleat "L" across cleats "J" and nail to cleats "J" and "K" with three twentypenny nails at each end as shown in detail 4, figure 136.
- (5) *End cleats "M"* (2 x 4 x 18, total of eight rqr). Locate a cleat "M" on car floor at each end of load, with end flush against cleat "H," near each side of car, and secure with four thirtypenny nails. Locate one cleat "M" on top of each lower cleat and secure with four thirtypenny nails as shown in detail 4, figure 136.

281. Marking

a. Identification marking will be stamped on metal tags after which tags will be dipped in ordnance yellow paint, and securely attached with soft wire on the front and rear of each vehicle. Marking will consist of nomenclature, stock number, gross weight, cubage, and shipping dimensions.

b. Processing directive (identifying number), symbol of installation performing processing, and date processed, will be stenciled with gasoline-soluble white or yellow paint on the inside surface of the windshield, opposite to the driver.

c. The complete coded oversea address (where applicable) will be stenciled in an unobstructed location (front and rear) with gasoline-soluble paint (white or yellow on OD surfaces). The stenciling will be in letters not more than 1½ inches nor less than ¾ inch high. An equilateral triangle (ordnance yellow) not more than 3 inches nor less than 1½ inches high will be stenciled on each vehicle adjacent to the oversea address.

d. Marking of boxed items will be in accordance with TM 9-1005.

Section II. DESTRUCTION OF MATERIEL TO PREVENT ENEMY USE

282. General

a. Destruction of the utility truck M38, when subject to capture or abandonment in the combat zone, will be undertaken by the using arm only when, in the judgment of the unit commander concerned, such action is necessary in accordance with orders of, or policy established by, the army commander. When in the possession of ordnance maintenance personnel, destruction will be in accordance with FM 9-5 and the information below as applicable.

b. The information which follows is for guidance only. Certain of the procedures outlined require the use of explosives and incendiary grenades which normally may not be authorized items for the trailer. The issue of these and related materials, and the conditions under which destruction will be effected, are command decisions in each case, according to the tactical situation. Of the several means of destruction, those most generally applicable are—

Mechanical —Requires axe, pick mattock, sledge, crowbar, or similar implement.

Burning —Requires gasoline, oil, incendiary grenades, or other flammables.

Demolition —Requires suitable explosives or ammunition.

Gunfire —Includes artillery, machineguns, rifles using rifle grenades, and launchers using antitank rockets. Under some circumstances hand grenades may be used.

In general, destruction of essential parts, followed by burning will usually be sufficient to render the material useless. However, selection of the particular method of destruction requires imagination and resourcefulness in the utilization of the facilities at hand under the existing conditions. Time is usually critical.

c. If destruction to prevent enemy use is resorted to, the materiel must be so badly damaged that it cannot be restored to a usable condition in the combat zone either by repair or cannibalization. Adequate destruction requires that all parts essential to the operation of the materiel, including essential spare parts, be destroyed or damaged beyond repair. However, when lack of time and personnel prevents destruction of all parts, priority is given to the destruction of those parts most difficult to replace. Equally important, the same essential parts must be destroyed on all like materiel so that the enemy cannot construct one complete unit from several damaged ones.

d. If destruction is directed, due consideration should be given to:

- (1) Selection of a point of destruction that will cause greatest obstruction to enemy movement and also prevent hazard to friendly troops from fragments or ricocheting projectiles which may occur incidental to the destruction.
- (2) Observance of appropriate safety precautions.

283. Method No. 1—Destruction by Burning

- a.* Remove and empty portable fire extinguishers.
- b.* Using an axe, pick mattock, sledge, or other heavy implement, smash all vital elements such as distributor, carburetor, generator, ignition coil, fuel pump, spark plugs, air cleaner, lights, instruments, and controls. If time permits, and a sufficiently heavy implement is available, smash the engine cylinder block and head, crankcase, and transmission.
- c.* Slash tires. If tires are inflated, exercise care to prevent injury should the tire blow out while being slashed. Whenever practicable, it is usually preferable to deflate tires before slashing.
- d.* Remove the drain plug from the fuel tank or puncture the tank as near the bottom as possible, collecting gasoline for use as outlined in *f* below.
- e.* Explosive ammunition, if available nearby, should be removed from packing or other protective material. Place ammunition on and about the entire utility truck so that it will be fully exposed to the fire and in such locations that the greatest damage will result from its detonation. Remove any safety devices from the ammunition.
- f.* Pour gasoline or oil in and over the entire utility truck. Ignite by means of an incendiary grenade fired from a safe distance, by a burst from a flame thrower, a combustible train of suitable length, or other appropriate means. Take cover immediately.

Caution: Cover must be taken without delay since an early explosion of the explosive ammunition, if present, may be caused by the fire. Due consideration should be given to the highly flammable nature of gasoline and its vapor. Carelessness in its use may result in painful burns.

If explosive ammunition is present, the danger zone is approximately 250 yards. Elapsed time: about 6 minutes.

284. Method No. 2—Destruction by Demolition

- a.* Remove and empty portable fire extinguishers.
- b.* Smash all vital elements as outlined in paragraph 283*b*.

c. Prepare two 2-pound charges of EXPLOSIVE, TNT (using two 1-lb blocks or equivalent together with the necessary detonating cord to make up each charge). Place the charges as follows:

- (1) Set the *first* charge on *top* of the clutch housing.
- (2) Set the *second* charge as low on the *left side* of the engine as possible.

d. Connect the two charges for simultaneous detonation with detonating cord.

e. Provide for dual priming to minimize the possibility of a misfire. For priming, either a nonelectric blasting cap crimped to at least 5 feet of safety fuse (safety fuse burns at the rate of 1 ft in approx 40 sec; test before using) or an electric blasting cap and firing wire may be used. Safety fuse, which contains black powder, and nonelectric blasting caps must be protected from moisture at all times. The safety fuse may be ignited by a fuse lighter or a match; the electric blasting cap requires a blasting machine or equivalent source of electricity.

Caution: Keep the blasting caps, detonating cord, and safety fuse separated from the charges until required for use.

Note. For the successful execution of methods of destruction involving the use of demolition materials, all personnel concerned will be thoroughly familiar with the pertinent provisions of FM 5-25. Training and careful planning are essential.

f. Destroy the tires by placing an incendiary grenade under each tire. The detonation of the explosive charges should be delayed until the incendiary fires are well started. This will prevent the fires from being extinguished by the blast when the charges are detonated.

g. Detonate the charges. If primed with nonelectric blasting cap and safety fuse, ignite and take cover. If primed with electric blasting cap, take cover before firing. The danger zone is approximately 250 yards. Elapsed time: about 6 minutes.

285. Method No. 3—Destruction by Gunfire

a. Remove and empty portable fire extinguishers.

b. Ordinarily destruction of the tires is effected incidental to and in conjunction with the destruction of the utility truck by gunfire. However, if such destruction is not practicable, destroy the tires as outlined in paragraph 283c or 284f.

c. Drain or puncture the fuel tank, unless incendiary grenades are to be used to destroy the tires.

d. Destroy the utility truck by gunfire using artillery, machine guns, rifles using rifle grenades, or launchers using antitank rockets. Fire on the utility truck aiming at the engine, axles, and wheels. Although one well-placed direct hit may render the utility truck temporarily useless, several hits are usually required for complete destruction unless an intense fire is started, in which case the materiel may be considered destroyed.

Caution: Firing artillery at ranges of 500 yards or less should be from cover. Firing rifle grenades or antitank rockets should be from cover. Elapsed time: about 4 minutes.

APPENDIX

REFERENCES

1. Publication Indexes

DA pamphlets of the 310-series and DA Pam 108-1 should be consulted frequently for latest changes or revisions of references given in this appendix and for new publications relating to materiel covered in this manual.

2. Supply Manuals

The following manuals of the Department of the Army Supply manual pertain to this materiel:

a. Destruction to Prevent Enemy Use.

Explosives and Demolitions.....	FM 5-25
Land Mines and Components; Demolition Explosives and Related Items; and Ammunition for Simulated Artillery, Booby Trap, Hand Grenade, and Land Mine Fire.	ORD 3 SNL R-7
Regulations for Firing Ammunition for Training, Target Practice, and Combat.	SR 385-310-1 AFR 50-13
Report of Malfunctions and Accidents Involving Ammunition and Explosives (During Training and Combat).	SR 700-45-6
Safety: Accident Reporting.....	SR 385-10-40

b. General.

Index of Supply Manuals—Ordnance Corps.	DA Pam 310-29 ORD 1
Introduction	

c. Maintenance and Repair.

Cleaners, Preservatives, Lubricants, Recoil Fluids, Special Oils, and Related Maintenance Materiels.	ORD 3 SNL K-1
Items of Soldering, Metallizing, Brazing and Welding Materiels: Gases and Related Items.	ORD 3 SNL K-2

Lubricating Equipment, Accessories, and Related Dispensers.	ORD (*) SNL K-3
Lubricating Fittings, Oil Filters, and Oil Filter Elements.	ORD 5 SNL H-16

d. Vehicle.

Truck, 1/4-Ton, 4 x 4 Utility, M38	ORD 7, 8, 9, SNL G-740
Winterization Equipment	ORD 9, SNL G-249 Sec. 9

3. Forms

The following forms pertain to this materiel :

- Standard Form 91, Operator's Report of Motor Vehicle Accident
- Standard Form 94, Statement of Witness
- DA Form 9-3, Processing Record for Shipment and Storage of
Vehicles and Boxed Engines
- DA Form 9-4, Vehicular Storage and Servicing Record
- DA Form 9-68, Spot Check Inspection Report for Wheeled and
Half-Track Vehicles
- DA Form 9-75, Daily Dispatching Record of Motor Vehicles
- DA Form 348, Driver Qualification Record
- DA Form 452-1, Placard-Documents Covering Shipment Are on
Other Side of Car
- DA Form 452-2, Placard-Documents Covering Shipment Are on
This Side of Car
- DA Form 460, Preventive Maintenance Roster
- DA Form 461, Preventive Maintenance Service and Inspection
for Wheeled and Half-Track Vehicles
- DA Form 461-5, Limited Technical Inspection
- DA Form 468, Unsatisfactory Equipment Report
- DA Form 478, Organizational Equipment File
- DA Form 811 and 811-1, Work Request and Job Order and Receipt
- DA Form 1208, Report of Claims Officer (cut sheet)
- DD Form 6, Report of Damaged or Improper Shipment
- DD Form 313, U. S. Government Operator's Permit
- DD Form 317, Preventive Maintenance Service

4. Other Publications

The following explanatory publications contain information pertinent to this materiel and associated equipment :

a. Camouflage.

Camouflage, Basic Principles	FM 5-20
Camouflage of Vehicles	FM 5-20B

(*) See DA Pam 310-29, Index of Supply Manuals—Ordnance Corps, for published types of manuals of the Ordnance section of the Department of the Army supply manual.

b. Decontamination.

Decontamination	TM 3-220
Defense Against Chemical Attack.....	FM 21-40

c. Destruction to Prevent Enemy Use.

Explosives and Demolitions.....	FM 5-25
---------------------------------	---------

d. General.

Artillery Materiel and Associated Equipment.....	TM 9-2300
Association of American Railroad Rules Governing the Loading of Department of Defense Materiel on Open Top Cars. ¹ —Pamphlet	No. MD-7
Chassis Coating Compound (Underbody Com- pound), Description, Method of Application, and Equipment Used.	TB ORD 401
Cooling Systems: Vehicles and Powered Ground Equipment.	TM 9-2858
Driver's Manual	TM 21-305
Driver Selection, Training and Supervision.....	TM 21-300
Fuel-Burning Heaters for Winterization Equipment	TM 9-8662
Inspection of Ordnance Materiel in the Hands of Troops.	TM 9-1100
Instruction Guide: Operation and Maintenance of Ordnance Materiel in Extreme Cold (0° to -65° F.).	TM 9-2855
Military Vehicles	TM 9-2800
Motor Transportation, Operations.	
Motor Transport	FM 25-10
Mountain Operations	FM 70-10
Operations in the Arctic.....	FM 31-71
Precautions in Handling Gasoline.....	AR 850-20
Preparation of Ordnance Materiel for Deep-Water Fording.	TM 9-2853
Principles of Automotive Vehicles.....	TM 9-8000-1 (TM 9-2700)
Prevention of Motor Vehicle Accidents.....	AR 385-55
Reports of Accident Experience.....	SR 385-10-40
Spark Plugs	TB ORD 313
Storage Batteries, Lead-Acid Type.....	TM 9-2857
Motor Vehicles	AR 700-105
Unsatisfactory Equipment Report.....	AR 700-38

¹ Copies may be obtained from Aberdeen Proving Ground, Aberdeen, Md.

e. Maintenance and Repair.

Abrasive, Cleaning, Preserving, Sealing, Adhesive, and Related Materiel Issued for Ordnance Materiel.	TM 9-850
Cleaning Lead-Acid Type Storage Batteries	TB ORD 557
Hand, Measuring, and Power Tools	TM 10-590
Instruction Guide: Care and Maintenance of Ball and Roller Bearings.	TM 37-265
Lubrication	TM 9-2835
Lubrication Order	LO 9-8012
Maintenance and Care of Hand Tools	TM 9-867
Maintenance and Care of Pneumatic Tires and Rubber Treads.	TM 31-200
Inspection and Reports Ordnance Corp Materiel . .	AR 750-925
Maintenance Responsibilities and Shop Operation . .	AR 750-5
Painting Instructions for Field Use	TM 9-2851
Preparation of Ordnance Materiel for Deep Water Fording.	TM 9-2853
Tactical Motor Vehicle Inspection and Preventive Maintenance Services.	TM 9-2810
Wheeled and Half-Track Vehicles, Trailers, and Towed Artillery: Lubrication of Wheel Bearings.	TB 9-2835-12

Note. For a complete listing of cleaning, preservation, packaging, and packing specifications, consult the *Operational List of Packaging Specifications and Instructions (General Supply)*. Copies may be obtained from Commanding Officer, Rossford Ordnance Depot, Toledo 1, Ohio, Attention: ORDWD-P.

f. Shipment and Limited Storage.

Army Shipping Document	TM 38-705
Instruction Guide: Ordnance Packaging and Shipping (Posts, Camps, and Stations).	TM 9-1005
Marking and Packing of Supplies and Equipment: Marking of Arctic-Lubricated Materiel and Equipment.	SR 746-30-10
Marking and Packing of Supplies and Equipment: Shipment and Digit Marking.	SR 746-30-6
Marking and Packing of Supplies and Equipment: Marking of Oversea Supply.	SR 746-30-5
Marking for Shipment and Storage	MIL STD 129A ¹
Ordnance Storage and Shipment Chart—Group G.	TB 9-OSSC-G
Preparation of Supplies and Equipment: Processing of Unboxed and Uncrated Equipment for Oversea Shipment.	AR 747-30

¹ Copies may be obtained from Philadelphia Quartermaster Depot, 2800 S. 20th St. Philadelphia, Pa.

Preservation, Packaging, and Packing of Military Supplies and Equipment.	TM 38-230
Processing of Motor Vehicles and Related Unboxed Materiel for Shipment and Storage.	SB 9-4
Protection of Ordnance General Supplies in Open Storage.	TB ORD 379
Reusable Shipping Containers for Tank and Automotive Assemblies: Proper Use and Care.	SB 9-69
Shed and Open Storage of Supplies.....	SR 743-5-10
Report of Damaged or Improper Shipment.....	SR 745-45-5
Standards for Oversea Shipment and Domestic Issue of Ordnance Materiel Other than Ammunition and Army Aircraft.	TB ORD 385
Station Supply Procedure.....	TM 38-403
Storage in the Zone of Interior.....	TM 38-402
Loading Rules, Test Loadings, and Test Shipments	SR 55-155-1

INDEX

	<i>Paragraph</i>	<i>Page</i>
Accelerator control -----	130	156
Accelerator pedal -----	15	22
Air cleaner -----	127, 132	149, 164
Air intake system. (<i>See</i> Fuel and air intake system.)		
Air intake, troubleshooting -----	79	78
Ammeter -----	30, 174	25, 224
Auxiliary power receptacle -----	150	190
Axle, front:		
Coordination with ordnance maintenance unit -----	222	254
Data -----	221	254
Description -----	4, 221	6, 254
Organization maintenance -----	223	254
Shafts -----	224	254
Troubleshooting -----	93	96
Axle, rear:		
Assembly -----	220, 231	252, 266
Bearings, hub -----	225	259
Bearings, knuckle flange cap -----	230	262
Bearings, shaft -----	216	250
Brakedrum -----	219, 228	252, 261
Coordination with ordnance maintenance unit -----	213	246
Data -----	212	246
Description -----	4, 212	6, 246
Drum, brake -----	219, 228	252, 261
Flange seal -----	229	261
Hub -----	218, 226	251, 261
Oil seals, inner -----	217	251
Organizational maintenance -----	214	246
Seal, hub bearing -----	227	261
Seal, knuckle flange -----	229	261
Seal, oil, inner -----	217	251
Shaft -----	215	246
Troubleshooting -----	94	97
Battery:		
Cables -----	156	201
Data -----	154	196
Description -----	154	196
Installation -----	155	198
Removal -----	155	198
Troubleshooting -----	84	85
Belt, fan, and generator drive -----	123	144
Blackout headlight -----	158	205
Blackout light -----	160	208
Blackout marker light -----	159	207
Blocking for rail shipment -----	280	324

	<i>Paragraph</i>	<i>Page</i>
Body and frame:		
Bumper -----	269	317
Data -----	258	302
Description -----	258	302
Fenders -----	262	305
Hood -----	261	304
Mirror -----	271	318
Organizational maintenance -----	259	303
Pintle -----	267	312
Radiator guard -----	263	307
Reflectors -----	270	318
Seats and cushions -----	268	314
Shackles -----	267	312
Top, doors, and side curtains -----	264	307
Windshield -----	260	303
Windshield wiper -----	265, 266	311, 312
Brake, hand. (See Brake system.)		
Brake system:		
Bleed -----	246	290
Cylinder, master -----	244	283
Cylinder, wheel -----	243	283
Data -----	240	277
Description -----	240	277
Fittings -----	245	285
Handbrake -----	247	291
Handbrake handle -----	20	23
Lines and fittings -----	245	285
Master cylinder -----	244	283
Organizational maintenance -----	241	278
Service brakes -----	242	278
Troubleshooting -----	95, 96	98, 99
Wheel cylinder -----	243	283
Bumpers -----	269	317
Button, horn -----	184	229
Cables, battery -----	156	201
Carburetor -----	127, 129	149, 151
Caution plates -----	5	10
Choke control -----	22, 130	23, 156
Cleaning -----	74	60
Clutch:		
Data -----	195	233
Description -----	195	233
Linkage adjustment -----	196	233
Pedal -----	14	22
Troubleshooting -----	89	93
Coil, ignition -----	144, 146	184, 185
Cold weather -----	272, 273	318, 319
Common tools and equipment -----	64	49
Controls and instruments:		
Accelerator pedal -----	15	22
Ammeter -----	30	25

	Paragraph	Page
<i>Controls and Instruments—Continued</i>		
Brake pedal	13	20
Choke control	22	23
Clutch pedal	14	22
Dimmer switch	34	26
Fuel filter	28	25
Fuel gage	26	24
Fuel tank level sending unit	27	25
General	11	20
Handbrake handle	20	23
Headlight dimmer switch	34	26
Headlight indicator light	40	27
Horn button	35	27
Ignition switch	32	26
Instrument panel lights	39	27
Lights, instrument panel	39	27
Light switch	33	26
Map compartment lock	41	28
Oil pressure gage	25	24
Speedometer	31	25
Starter pedal	16	22
Steering wheel	12	20
Temperature gage	20	25
Throttle control	21	23
Transfer front wheel drive gearshift lever	17	22
Transfer high and low range gearshift lever	18	22
Transmission gearshift lever	19	23
Valve, vent control	23	24
Vent control valve	23	24
Water temperature gage	29	25
Winch controls	24	24
Windshield lock	38	27
Windshield wiper manual control	37	27
Windshield wiper regulating valve	36	27
<i>Cooling system:</i>		
Belts, fan and generator drive	123	144
Data	120	140
Description	120	140
Fan	124	146
Hose	125	147
Organizational maintenance	121	142
Radiator	122	143
Thermostat	126	148
Troubleshooting	85	86
Water pump	124	146
<i>Data:</i>		
Axle, front	221	254
Axle, rear	212	246
Battery	154	196
Body and frame	258	302
Brake system	5	10
Clutch	195	233

	<i>Paragraph</i>	<i>Page</i>
<i>Data—Continued</i>		
Cooling system -----	120	140
Engine -----	101	105
Fuel and air intake system -----	127	149
Generating system -----	151	192
Ignition system -----	140	175
Lighting system -----	154	196
Power-take-off -----	197	234
Propeller shafts and universal joints -----	208	239
Springs and shock absorbers -----	248	293
Starting system -----	147	187
Steering system -----	232	267
Transfer -----	197	234
Transmission -----	203	237
Winch -----	54	37
Data plates -----	5	10
Data, tabulated -----	6	16
Decalcomanias -----	5	10
Deficiencies, correction -----	10	20
Description -----	4	6
Destruction:		
Burning -----	283	332
Demolition -----	284	332
General -----	282	331
Gunfire -----	285	333
Distributor -----	143	181
Distributor with coil -----	146	185
Drive shaft, winch -----	169	217
Driving vehicle -----	44, 45, 46, 48, 49, 50, 51	29, 30, 32, 33
Electrical system, description -----	4	6
Engine:		
Air cleaner control valve -----	107	114
Crankcase control valve -----	107	114
Cylinder head -----	104	111
Data -----	101	105
Description -----	4, 101	6, 105
Fittings -----	113	122
Gasket, cylinder head -----	103	106
Installation -----	118, 119	133
Lines -----	113	122
Manifold gasket replacement -----	109	118
Manifold replacement -----	108	115
Metering valves -----	107	114
Oil filter replacement -----	110, 111	118, 120
Operations performed while in vehicle -----	102	105
Removal -----	114, 116, 117	122, 123
Serial number -----	5	10
Starting -----	43	28
Stopping -----	51	33
Troubleshooting -----	78	73
Valve adjustment -----	105, 106	111, 113

	<i>Paragraph</i>	<i>Page</i>
Exhaust system:		
Description -----	137	172
Exhaust pipe -----	138	172
Muffler -----	139	174
Troubleshooting -----	80	81
Fan -----	124	146
Fenders -----	262	305
Filter, fuel. (<i>See</i> Fuel and air intake system.)		
Filter, oil replacement -----	110, 111	118, 120
Fording -----	23, 61, 275	24, 46, 320
Forms -----	3	5
Frame. (<i>See</i> Body and frame.)		
Front axle. (<i>See</i> Axle, front.)		
Fuel and air intake system:		
Accelerator -----	130	156
Air cleaner -----	132	164
Carburetor -----	129	151
Choke -----	130	156
Data -----	127	149
Description -----	127	149
Fuel and vacuum pump -----	131	161
Fuel filter -----	28, 133,	25, 165,
	134	167
Lines and fittings -----	135	168
Tank -----	136	171
Throttle -----	130	156
Troubleshooting -----	79	78
Fuel and vacuum pump -----	131	161
Fuel gage -----	175	224
Gage. (<i>See</i> Item for which used.) (<i>See</i> Instrument cluster.)		
Gages, troubleshooting -----	87	88
Gasket, cylinder head -----	103	106
Gasket, manifold replacement -----	109	118
Generating system:		
Data -----	151	192
Description -----	151	192
Generator -----	152	194
Radio interference suppression -----	183	228
Regulator -----	153	196
Troubleshooting -----	83	84
Generator -----	152	194
Ground straps -----	194	232
Head, cylinder, replacement -----	104	111
Headlight -----	157	202
Hood -----	261	304
Horn. (<i>See also</i> Instrument cluster.)	86, 185	88, 229
Hose -----	125	146

	<i>Paragraph</i>	<i>Page</i>
Ignition system:		
Cables	145	185
Capacitor	143	181
Coil	144, 146	184, 185
Data	140	175
Description	140	175
Distributor	143	181
Distributor with coil	146	185
Organizational maintenance	141	176
Plugs	145	185
Radio interference suppression	192	232
Timing	142	176
Troubleshooting	81	82
Indicator light, headlight	179	226
Instruction plates	5	10
Instrument cluster, instruments, gages, switches, sending units, and horn:		
Ammeter	174	224
Button, horn	184	229
Fuel gage	175	224
General	172	220
Horn	185	229
Indicator light, headlight	179	226
Instrument cluster	173	222
Instrument panel lights	161, 180	210, 227
Oil pressure gage	177	225
Sending unit, fuel tank level	189	231
Sending unit, troubleshooting	87	88
Sending unit, water temperature	187	230
Speedometer	178	225
Switch, dimmer	183	228
Switch, horn	184	229
Switch, ignition	181	227
Switch, light	182	228
Troubleshooting	87	88
Water temperature gage	176	225
Light. (See also Lighting system.)		
Light, beam indicator	40	27
Lighting system:		
Blackout headlight	158	205
Blackout light	160	208
Blackout marker light	159	207
Cables	163	212
Circuits	163	212
Data	154	196
Description	154	196
Headlight	157	202
Headlight beam indicator light	164	213
Instrument panel light	161	210
Service parking lights	159	207
Stop light	160	208
Taillight	160	208
Trailer coupling connector receptacle	162	211

	<i>Paragraph</i>	<i>Page</i>
Lights, instrument panel	39	27
Lights, troubleshooting	84	85
Lines, fuel	135	168
Loading for rail shipment	279	324
Lock, map compartment	41	28
Lock, windshield	38	27
Lubrication:		
After dusty or sandy conditions	71	59
After fording	70	57
Below 0° F.	69	57
Order	66	50
Instructions	67	50
Unusual conditions	68	51
Maintenance under unusual conditions:		
Extreme-cold weather	272, 273	318, 319
Fording	275	320
Operation on unusual terrain	276	322
Manifold replacement	108	115
Mirror	271	318
Muffler	139	174
Nameplates	5	10
Oil pressure gage	177	225
Operation:		
Cold weather	57, 58	41, 42
Fording	61	46
General	42	28
Hot weather	59	44
Unusual conditions	56	40
Unusual terrain	276	322
Operations performed with engine in vehicle	102	105
Organizational maintenance:		
Allocation	2	4
Body	259	303
Brakes	241	278
Cooling system	121	142
Frame	259	303
Front axle	223	254
Fuel and air intake system	128	151
General	233	268
Ignition system	141	176
Power-take-off	199	235
Rear axle	214	246
Springs and shock absorbers	249	294
Tires	254	299
Transfer	199	235
Transmission	205	238
Wheels	255	299
Winch	167	215
Painting	72	59
Parts	62	48

	<i>Paragraph</i>	<i>Page</i>
Pintle -----	267	312
Plates, name, caution, data, and instruction -----	5	10
Plugs, spark. (See Spark plug.)		
Power plant installation -----	119	133
Power plant removal -----	114, 116	122
Power-take-off:		
Coordination with ordnance maintenance unit -----	198	235
Data -----	197	234
Description -----	24, 197	24, 234
Installation -----	202	236
Organizational maintenance -----	199	235
Removal -----	202	236
Preventive maintenance service:		
Cleaning -----	74	60
Daily "A" and biweekly "B" -----	75	61
General -----	73	59
Mileage "C" and semiannual—mileage "D" -----	76	63
Propeller shafts and universal joints:		
Data -----	208	239
Description -----	208	239
Installation -----	209	239
Removal -----	209	239
Sleeve yokes -----	211	244
Troubleshooting -----	92	96
Universal joints -----	210	241
Pump, fuel, and vacuum -----	127, 131	149, 161
Pump, water -----	124	146
Radiator -----	122	143
Radiator guard -----	263	307
Radio interference suppression:		
Description -----	88, 191	91, 231
Fasteners -----	194	232
Generating system -----	193	232
Ground straps -----	194	232
Ignition system -----	192	232
Purpose -----	190	231
Rail shipment -----	279, 280	324
Rear axle. (See Axle, rear.)		
Receptacle, trailer coupling -----	162	211
Records -----	3	5
Reflectors -----	270	318
Regulator, generator -----	153	196
Reports -----	3	5
Seats and cushions -----	268	314
Sending unit. (See Item for which used.) (See Instrument cluster.)		
Serial number plate -----	5	10
Service parking light -----	159	207
Service upon receipt of material:		
Break-in -----	9	19
Correction of deficiencies -----	10	20

	<i>Paragraph</i>	<i>Page</i>
<i>Service upon receipt of material—Continued</i>		
Preliminary	8	18
Purpose	7	18
Shackles	267	312
Shifting gears	46, 47, 48	30, 31, 32
Shipping instructions, domestic	277	323
Shock absorbers:		
Troubleshooting	98	100
Spark plug	145	185
Special tools and equipment	65	49
Speedometer	31, 178	25, 225
Springs and shock absorbers:		
Data	248	293
Description	248	293
Organizational maintenance	249	294
Pivot bolts	251	296
Shackles	250	294
Shock absorbers	253	298
Springs	252	297
Troubleshooting	98	100
Starting system:		
Auxiliary power receptacle	150	190
Data	147	187
Description	147	187
Pedal	16	22
Switch	149	190
Starter	148	182
Troubleshooting	82	83
Steering system:		
Adjustment, toe-in	234	269
Bellcrank	238	273
Data	232	267
Description	232	267
Drag link	237	272
Ends, tie rod	236	272
Organizational maintenance	233	268
Steering gear	239	274
Tie rod	235	270
Tie rod ends	236	272
Toe-in adjustment	234	269
Troubleshooting	99	101
Stoplight	160	208
Storage instructions	278	324
Switch. (<i>See also</i> Instrument cluster.)		
Switch:		
Dimmer	33, 183	26, 228
Horn	184	229
Ignition	32, 181	26, 227
Light	33, 52, 182	26, 33, 228
Starter	149	190
Stoplight	186	229
Troubleshooting	87	88

	<i>Paragraph</i>	<i>Page</i>
Tables:		
I. Special Tools and Equipment for Organizational Maintenance.	65	49
II. Driver's or Operator's Preventive Maintenance Services.	75	61
III. Organizational Mechanic or Maintenance Crew "C" and "D" Preventive Maintenance Services.	76	63
IV. Circuit Numbers and Descriptions -----	163	212
Taillight -----	160	208
Tank, fuel -----	127, 136	149, 171
Tank sending unit -----	27	25
Thermostat -----	126	148
Throttle control -----	130	156
Timing ignition -----	142	176
Tires:		
Data -----	254	299
Description -----	254	299
Instructions regarding -----	257	302
Organizational maintenance -----	255	299
Troubleshooting -----	97	99
Top, doors, and side curtains -----	264	307
Towing vehicle -----	53	34
Transfer:		
Coordination with ordnance maintenance unit -----	198, 204	235, 238
Data -----	197	234
Description -----	197	234
Gearshift lever -----	17, 18	22
Installation -----	118, 119, 201, 207	133, 235, 238
Organizational maintenance -----	199, 205	235, 238
Removal -----	114, 116, 117, 200, 206	122, 132, 235, 238
Shifting gears -----	47	31
Troubleshooting -----	91	95
Transmission:		
Data -----	203	237
Description -----	4, 203	6, 237
Gearshift lever -----	19	23
Installation -----	118, 119	133
Removal -----	114, 116, 117	122, 132
Shifting gears -----	46, 50	30, 33
Troubleshooting -----	90	94
Troubleshooting:		
Air intake and fuel system -----	79	78
Battery -----	84	85
Brake, hand -----	96	99
Brake, service -----	95	98
Clutch -----	89	93
Cooling system -----	85	86
Engine -----	77	72
Exhaust system -----	80	81
Front axle -----	93	96
Fuel and air intake system -----	79	78

	<i>Paragraph</i>	<i>Page</i>
Troubleshooting—Continued		
Gages	87	88
Generating system	83	84
Horn	86	88
Ignition system	81	82
Instruments	87	88
Lighting	84	85
Propeller shafts	92	96
Rear axle	94	97
Scope	77	72
Sending units	87	88
Springs and shock absorbers	98	100
Starting system	82	83
Steering	99	101
Switches	87	88
Tires	97	99
Transfer	91	95
Transmission	90	94
Universal joints	92	96
Wheels	97	99
Windshield wipers	100	104
Universal joint, winch	170	219
Vacuum pump	131	161
Valve:		
Adjustment	105, 106	111, 113
Control	107	114
Fuel shutoff	127	149
Metering	107	114
Windshield wiper motor	36	27
Water pump	124	146
Water temperature gage	29, 176	25, 225
Wheels:		
Data	254	298
Description	254	299
Installation	256	300
Organizational maintenance	255	299
Removal	256	300
Troubleshooting	97	99
Winch:		
Adjustment	168	215
Controls	24	24
Coordination with ordnance maintenance unit	166	213
Data	54	37
Description	54, 165	37, 213
Drive shaft	169	217
Hanger bearing	171	219
Installation	168	215
Operation	55	38
Removal	168	215
Universal joint	170	219
Windshield	260	303

Windshield wipers -----	100,265,	104,311,
	266	312
Wiring circuits and cables-----	163	212

[AG 451.2 (2 Sep 55)]

BY ORDER OF THE SECRETARIES OF THE ARMY
AND THE AIR FORCE:

MAXWELL D. TAYLOR,
General, United States Army,
Chief of Staff.

OFFICIAL:

JOHN A. KLEIN,
Major General, United States Army,
The Adjutant General.

N. F. TWINING,
Chief of Staff, United States Air Force.

OFFICIAL:

E. E. TORO,
Colonel, United States Air Force,
Air Adjutant General.

DISTRIBUTION:

Active Army:

CNGB (1)	229R, 9-347R, 9-367R, 9-387R (1).
Tec Svc, DA (1) except	Ft & Cp (2)
COFORD (25).	Gen & Br Svc Sch (2) except Ord
Ord Bd (2)	Sch (50).
Hq, CONARC (3)	PMST Ord ROTC Units (1)
Army AA Comd (2)	Gen Depots (2) except Atlanta Gen
OS Maj Comd (2)	Depot (None).
OS Base Comd (2)	Ord Sec, Gen Depots (5)
Log Comd (3)	Ord Depot (10) except Rossford Ord
MDW (1)	Depot (12), Anniston Ord Depot
Armies (3)	(18).
Corps (2)	POE (2)
Div (2)	OS Sup Agencies (1)
Brig (2)	Ord PG (10)
Regt Gp (1) except Ord	Ord Arsenal (5) except Raritan Ar-
Gp (2).	senal (100), Benicia Arsenal (20).
Bn (1) except Ord Bn (2)	Mil Dist (1)
except TOE: 9-45R (1).	Ord Proc Dist (10)
Ord Co (2) except TOE 9-	MAAG (1)
12R, 9-17R, 9-46R, 9-	Mil Msn (1)
47R, 9-49R, 9-57R, 9-	

NG: State AG (6): units—same as Active Army except allowance is one copy to each unit.

USAR: None.

For explanation of abbreviations used, see SR 320-50-1.